



memmert
Experts in Thermostatics

UFTS



OPERATING MANUAL

PASS-THROUGH OVEN UFTS

100% ATMOSAFE. MADE IN GERMANY.

www.memmert.com | www.atmosafe.net

Manufacturer and customer service

MEMMERT GmbH + Co. KG
Willi-Memmert-Straße 90-96
91186 Büchenbach
Germany

Phone: +49 (0)9122 925-0
Fax: +49 (0)9122 14585
E-mail: sales@memmert.com
Internet: www.memmert.com

Customer service:

Service hotline: +49 (0)9171 9792 911
Service fax: +49 (0)9171 9792 979
E-mail: service@memmert.com

When calling for service enquiries, please state the appliance number given on the name-plate (see page 13).

Shipping address for repairs:

Memmert GmbH + Co. KG
Customer service
Willi-Memmert-Str. 90-96
DE-91186 Büchenbach
Germany

Please contact our customer service before sending appliances for repair or before re-
turning equipment, otherwise, we have to refuse acceptance of the shipment.

About this manual

Purpose and target audience

This manual describes the construction, function, transport operation and maintenance of pass-through ovens UFTS. It is intended for use by trained personnel of the owner, who have the task of operating and/or maintaining the respective appliance.

If you are asked to work on the appliance, read this manual carefully before starting. Familiarise yourself with the safety regulations. Only perform work that is described in this manual. If there is something you do not understand, or certain information is missing, ask your manager or contact the manufacturer. Do not do anything without authorisation.

Versions

The appliances are available in different configurations and sizes. If specific equipment features or functions are available only for certain configurations, this is indicated at the relevant points in this manual.

The functions described in this manual refer to the latest firmware version.

Due to individual configurations and sizes, illustrations in this manual may be slightly different from the actual appearance. Function and operation are identical.

Other documents that have to be observed:

- ▶ Observe the relevant manual when operating the appliance with MEMMERT AtmoCONTROL computer software. Click on “Help” on the AtmoCONTROL menu bar to open the AtmoCONTROL software manual.
- ▶ Please refer to the separate service manual for service and repair work (see page 56).

Storage and resale

This operating manual belongs with the appliance and should always be stored where persons working on the appliance have access to it. It is the owner's responsibility to ensure that persons who are working on or are going to work on the appliance know where to find the operating manual. We recommend that it is always stored in a protected location close to the appliance. Make sure that the operating manual is not damaged by heat or humidity. If the appliance is resold or transported and then set up again at a different location, the operating manual must remain with it.

The current version of this operating manual in PDF format is also available for download from <http://www.memmert.com/en/service/downloads/user-manual/>.

1. For your safety

1.1 Terms and signs used

In this manual and on the appliance itself, certain common terms and signs are used to warn you of possible dangers or to give you hints that are important in avoiding injury or damage. Observe and follow these notes and regulations to avoid accidents and damage. These terms and signs are explained below.

1.1.1 Terms used



is used whenever you or somebody else could be injured if you do not observe the accompanying safety regulation.



is used for information that is important for avoiding damage.

1.1.2 Signs used

Warning signs (warning of a danger)



Danger of electrocution



Danger of explosion



Dangerous gases / vapours



Danger of burns



Danger of toppling over



Hazard area! Observe the operating instructions

Prohibition signs (forbidding an action)



Do not lift



Do not tilt



Do not enter

Regulation signs (stipulating an action)



Disconnect the mains plug



Wear gloves



Wear safety boots



Observe information in separate manual

Other icons



Important or useful additional information

1.2 Product safety and dangers

The appliances described in this manual are technically sophisticated, manufactured using high-quality materials and subject to many hours of testing in the factory. They reflect the state of the art and comply with recognised technical safety regulations. However, there are still risks involved, even when the appliances are used as intended. These are described below.

⚠ WARNING



Live components may be exposed once the covers have been removed. Touching these can lead to an electrical shock. Disconnect the mains plug before removing any covers. Work on the electrical system must only be performed by qualified electricians.

⚠ WARNING



Poisonous or explosive vapours or gases may be produced if the appliance is loaded with an unsuitable load. This could cause the appliance to explode, and people could be severely injured or poisoned. The appliance may only be loaded with materials/test objects which do not release any toxic or explosive vapours when heated (see also chapter Intended use on page 6).

⚠ WARNING



Leaving the door open during operation can cause the appliance to overheat or pose a fire hazard. Do not leave the door open during operation.

⚠ WARNING



Depending on operation, the surfaces in the interior of the appliance and the chamber load may still be very hot after the appliance is switched off. Touching these surfaces can cause burns. Wear heat-resistant protective gloves or wait until the appliance cools down first.

⚠ WARNING



With appliances above a specific size, you could become accidentally locked inside the appliance, which could put you at risk of death. Do not climb into the appliance!

1.3 Requirements of the operating personnel

The appliance may only be operated and maintained by persons who are of legal age and have been instructed accordingly. Personnel who are to be trained, instructed or who are undergoing general training may only work with the appliance under the continuous supervision of an experienced person.

Repairs may only be performed by qualified electricians. The regulations in the separate service manual must be observed.

1.4 Responsibility of the owner

The owner of the appliance

- ▶ is responsible for the flawless condition of the appliance and for it being operated in accordance with its intended use (see page 6);
- ▶ is responsible for ensuring that persons who are to operate or service the appliance are qualified to do this, have been instructed accordingly and are familiar with the operating instructions at hand;
- ▶ must know about the applicable guidelines, requirements and operational safety regulations, and train staff accordingly;
- ▶ is responsible for ensuring that unauthorised persons have no access to the appliance;
- ▶ is responsible for ensuring that the maintenance plan is adhered to and that maintenance work is carried out properly (see page 56);
- ▶ has to ensure that the appliance and its surroundings are kept clean and tidy, for example through corresponding instructions and inspections;
- ▶ is responsible for ensuring that personal protective clothing is worn by operating personnel, e.g. work clothes, safety shoes and protective gloves.

1.5 Intended use

This appliance is intended exclusively for heating up non-explosive substances and objects. Any other use is improper and may result in hazards and damage.

The appliance is not explosion-proof (does not comply with the German occupational health and safety regulation VBG 24). The appliance may only be loaded with materials and substances which cannot form any toxic or explosive vapours at the set temperature and which cannot explode, burst or ignite.

The appliance may not be used for the drying, evaporation and burning-in of paints or similar materials, the solvents of which could form an explosive mixture when combined with air. If there is any doubt as to the composition of materials, they must not be loaded into the appliance. Potentially explosive gas-air mixtures must not form, neither in the working chamber nor in the direct vicinity of the appliance.

1.6 Changes and conversions

No unauthorised changes or alterations may be made to the appliance. No parts may be added or inserted which have not been approved by the manufacturer.

Unauthorised changes or alterations result in the CE declaration of conformity losing its validity, and the appliance may no longer be operated.

The manufacturer is not liable for any damage, danger or injuries that result from unauthorised changes or alterations, or from non-compliance with the provisions in this manual.

1.7 Behaviour in case of malfunctions and irregularities

The appliance may only be used in a flawless condition. If you as the operator notice irregularities, malfunctions or damage, immediately take the appliance out of service and inform your superior.

i Information on eliminating malfunctions can be found from page 38.

1.8 Switching off the appliance in an emergency

Press the main switch on the ControlCOCKPIT (Fig. 1) and disconnect the power plug. This disconnects the appliance from the power supply at all poles.



⚠ WARNING

Depending on operation, the surfaces in the working chamber and the chamber load may still be very hot after the appliance is switched off. Touching these surfaces can cause burns. Wear heat-resistant protective gloves or wait until the appliance cools down before touching.

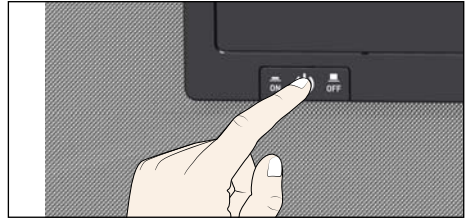

Fig. 1
Switch off the appliance by pressing the On/Off switch

Contents

1. For your safety	4
1.1 Terms and signs used.....	4
1.2 Product safety and dangers	5
1.3 Requirements of the operating personnel	6
1.4 Responsibility of the owner.....	6
1.5 Intended use.....	6
1.6 Changes and conversions.....	6
1.7 Behaviour in case of malfunctions and irregularities	7
1.8 Switching off the appliance in an emergency	7

Contents 8

2. Construction and description	10
2.1 Construction.....	10
2.2 Function.....	11
2.3 Material.....	11
2.4 Electrical equipment.....	11
2.5 Connections and interfaces.....	12
2.6 Designation (nameplate).....	13
2.7 Technical data	14
2.8 Applied directives and standards.....	15
2.9 Declaration of conformity	15
2.10 Ambient conditions.....	16
2.11 Scope of delivery	16
2.12 Optional accessories.....	16
3. Delivery, transport and setting up	17
3.1 For your safety.....	17
3.2 Delivery.....	17
3.3 Transport.....	17
3.4 Unpacking	17
3.5 Storage after delivery	18
3.6 Setting up.....	18
4. Putting into operation	21
4.1 Connecting the appliance	21
4.2 Switching on.....	22
5. Operation and control	23
5.1 Operating personnel.....	23
5.2 Opening the door.....	23
5.3 Loading the appliance.....	25
5.4 Operating the appliance.....	26
5.5 Temperature monitoring	32
5.6 Graph.....	36
5.7 Ending operation.....	37

6. Malfunctions, warning and error messages	38
6.1 Warning messages of the monitoring function.....	38
6.2 Malfunctions, operating problems and appliance errors	39
6.3 Power failure.....	41
7. Menu mode	42
7.1 Overview.....	42
7.2 Basic operation in menu mode using the example of language selection.....	43
7.3 Setup.....	44
7.4 Date and time.....	48
7.5 Calibration	49
7.6 Programme.....	51
7.7 Sounds.....	53
7.8 Protocol	54
7.9 USER ID.....	55
8. Maintenance and Servicing	56
8.1 Cleaning.....	56
8.2 Regular maintenance.....	56
8.3 Repairs and Service.....	57
9. Storage and disposal	58
9.1 Storage	58
9.2 Disposal	58
Index	59

2. Construction and description

2.1 Construction

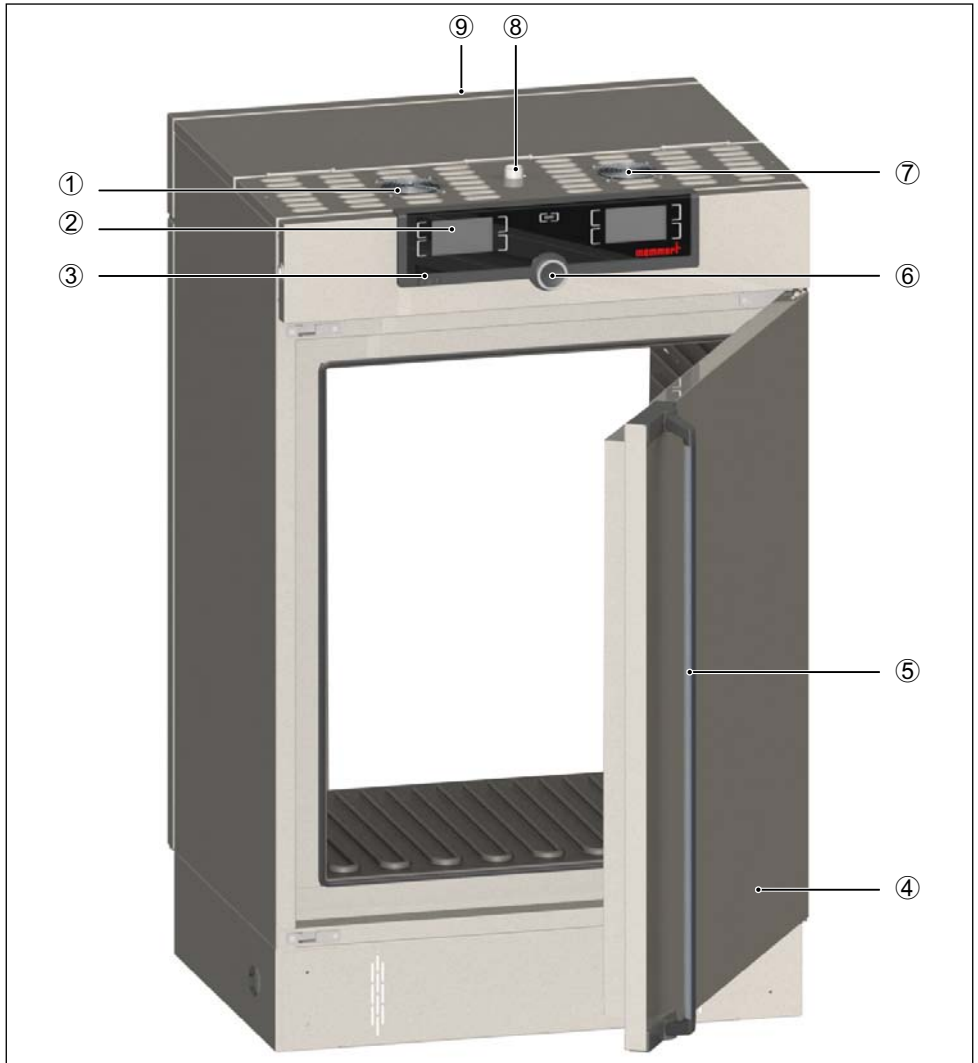

Fig. 2 Construction

- | | |
|---|---|
| 1 Control unit fan | 6 Turn control with confirmation key |
| 2 ControlCOCKPIT with capacitive function keys and LCD displays (see page 26) | 7 Control unit fan |
| 3 Main switch | 8 Exhaust air |
| 4 Nameplate (covered, see page 13) | 9 Transfer key (covered on the other appliance side, see page 24) |
| 5 Door handle (see page 23) | |

2.2 Function

UFTS type appliances feature forced circulation (convection). The piping is surrounded by an air jacket on both sides, which preheats the fresh air. The supplied air provides the air jacket with fresh air, which is pressed into the air jacket by a fan. Fresh air flows into the interior via ventilation slits in the piping. The air exhaust is located on the roof of the appliance ⑧.

The appliance may be equipped with a two-way door lock that prevents the door(s) from being opened on the cleanroom side and the greyroom side simultaneously (see page 24).

2.3 Material

For the outer housing, MEMMERT uses stainless steel (Mat.No. 1.4016 – ASTM 430) and for the interior, stainless steel (Mat.No. 1.4301 – ASTM 304) is used, which stands out through its high stability, optimal hygienic properties and corrosion resistance to many (but not all!) chemical compounds (caution for example with chlorine compounds).

The chamber load for the appliance must be carefully checked for chemical compatibility with the materials mentioned. A material resistance table can be requested from the manufacturer.

2.4 Electrical equipment

- ▶ Operating voltage and current consumption: See nameplate
- ▶ Protection class I, i.e. operating insulation with PE conductor in accordance with EN 61010
- ▶ Protection class IP 20 acc. to EN 60529
- ▶ Interference suppression acc. to EN 55011 class B
- ▶ Appliance fuse: Safety fuse 250 V/15 A, quick-blow
- ▶ The temperature controller is protected with a miniature fuse 100 mA (160 mA at 115 V)

2.5 Connections and interfaces

2.5.1 Electrical connection

This appliance is intended for operation on an electrical power system with a system impedance Z_{max} of a maximum of 0.292 ohm at the point of transfer (service line). The operator must ensure that the appliance is operated only on an electrical power system that meets these requirements. If necessary, you can ask your local energy supply company what the system impedance is.

Observe the country-specific regulations when making connections (e.g. in Germany DIN VDE 0100 with earth leakage circuit breaker).

2.5.2 Communication interfaces

The interfaces are intended for appliances which meet the requirements of IEC 60950-1.

USB port

The appliance is fitted by default with a USB port in accordance with the USB specification. This way, you can

- ▶ transfer software stored on a USB storage medium to the appliance (see page 51).
- ▶ export protocol logs from the appliance to a USB storage medium (see page 54).
- ▶ transfer user ID data stored on a USB storage medium to the appliance (see page 55).

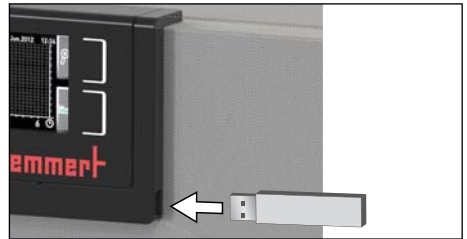

Fig. 3 USB port

The USB port is located on the right of the ControlCOCKPIT (Fig. 3).

Ethernet interface

The appliance can be connected to a network via the Ethernet interface, so that you can transfer programmes created with the AtmoCONTROL software to the appliance and read out protocols. The Ethernet interface is located on the left of the ControlCOCKPIT (Fig. 4).

For identification purposes, each appliance connected must have its own unique IP address. Setting the IP address is described on page 44.

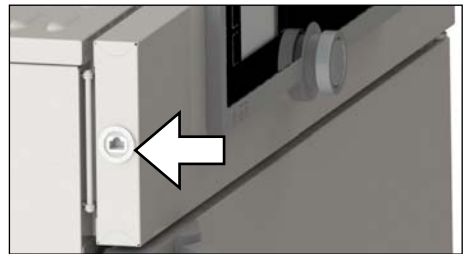

Fig. 4 Ethernet interface



You will find a description of how to transfer programmes via Ethernet in the enclosed AtmoCONTROL manual.

The appliance can be directly connected to a computer / laptop using an optional USB to Ethernet converter (see Scope of delivery on page 16).

2.6 Designation (nameplate)

The nameplate (Fig. 5) provides information about the appliance model, manufacturer and technical data. It is attached to the front of the appliance, on the right behind the door (see page 10).

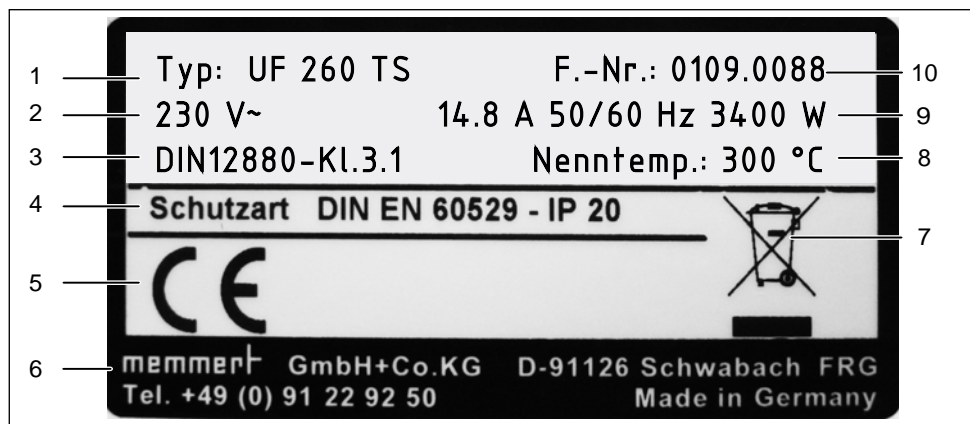

Fig. 5 Nameplate (example)

- | | | | |
|---|---------------------|----|----------------------------|
| 1 | Type designation | 6 | Address of manufacturer |
| 2 | Operating voltage | 7 | Disposal note |
| 3 | Applicable standard | 8 | Temperature range |
| 4 | Protection type | 9 | Connection / power ratings |
| 5 | CE conformity | 10 | Appliance number |

2.7 Technical data

Appliance size		160	260	450	750
Appliance width D ¹ [mm]		745	824	1224	1224
Appliance height E ¹ [mm]		1233	1314	1233	1714
Appliance depth G ¹ (footprint) [mm]		584	684	784	784
Depth of door lock [mm]		56			
Appliance depth F ¹ (including door handle) [mm]		696	796	896	896
Chamber width A ¹ [mm]		560	640	1040	1040
Chamber height B ¹ [mm]		720	800	720	1200
Chamber depth [mm]		400	500	600	600
Chamber volume [litres]		161	256	449	749
Weight [kg]		120	138	213	260
Power [W]	230 V, 50/60 Hz	3200	3400	–	–
	115 V, 50/60 Hz	1800	1800	–	–
	400 V, 50/60 Hz	–	–	5800 ²	7000 ²
Current consumption [A]	230 V, 50/60 Hz	13.9	14.8	–	–
	115 V, 50/60 Hz	15.5	15.5	–	–
	400 V, 50/60 Hz	–	–	3 x 8,4 ²	3 x 10,2 ²
max. number of sliding grids		8	9	8	14
max. load per sliding grid [kg]		20		30	
max. load per appliance [kg]		210	300		
Setting temperature range		+20 to +250 °C			
Adjustment precision		up to 99.9 °C: 0.1 K above 100 °C: 0.5 K			

¹ See Fig. 6 on page 15

² 3 x 230 V without neutral conductor

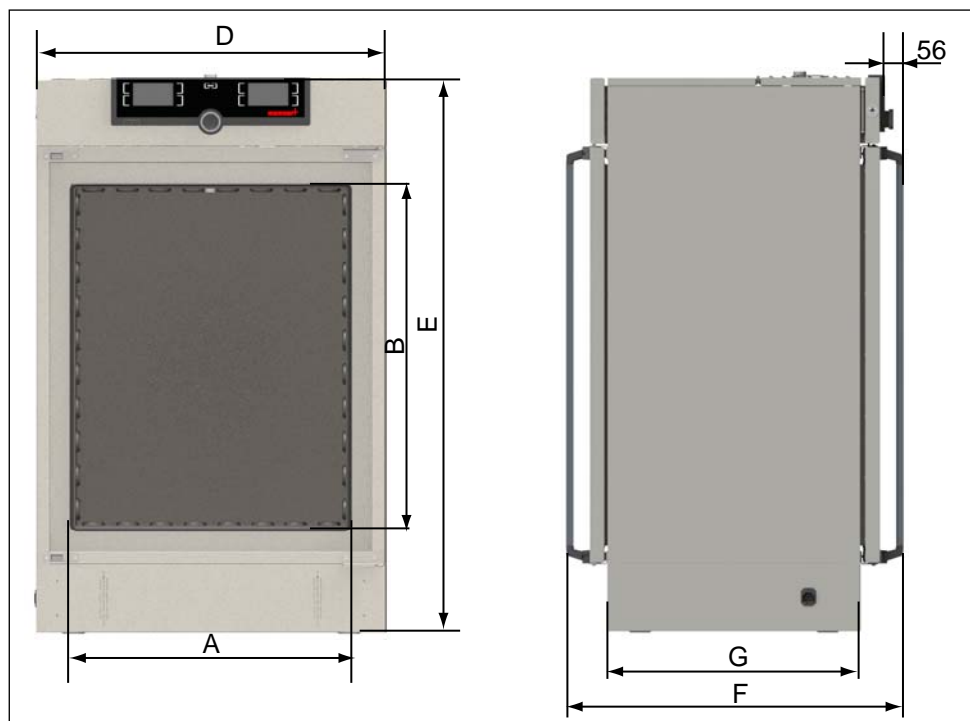

Fig. 6 Dimensions

2.8 Applied directives and standards

- ▶ Directive 2004/108/EC amended (Directive of the European Parliament and of the Council on the approximation of the laws of the Member States relating to electromagnetic compatibility). Standards complied with: DIN EN 61326:2004-05, EN 61326:1997, EN 61326/A1:1998, EN 61326/A2:2001, EN 61326/A2:2003
- ▶ Directive 2006/95/EC amended (Directive of the European Parliament and of the Council on the harmonisation of the laws of Member States relating to electrical equipment designed for use within certain voltage limits). Standards complied with: DIN EN 61 010-1 (VDE 0411 part 1), DIN EN 61 010-2-010 (VDE 0411 part 2-010), EN 61 010-1:2001, EN 61 010-2-010

2.9 Declaration of conformity

You can download the EC declaration of conformity of the appliance online:

English: <http://www.memmert.com/en/service/downloads/ce-statement/>

German: <http://www.memmert.com/de/service/downloads/eg-konformitaetserklaerung/>

2.10 Ambient conditions

- ▶ The appliance may only be used in enclosed areas and under the following ambient conditions:

Ambient temperature	+5 °C to +40 °C
Humidity rh	max. 80 % non-condensing
Overvoltage category	II
Pollution degree	2
Altitude of installation	max. 2,000 m above sea level

- ▶ The appliance may not be used in areas where there is a risk of explosion. The ambient air must not contain any explosive dusts, gases, vapours or gas-air mixtures. The appliance is not explosion-proof.
- ▶ Heavy dust production or aggressive vapours in the vicinity of the appliance could lead to sedimentation in the interior and, as a consequence, could result in short circuits or damage to electrical parts. For this reason, sufficient measures to prevent large clouds of dust or aggressive vapours from developing should be taken.

2.11 Scope of delivery

- ▶ Power cable
- ▶ Tilt protection
- ▶ Two sliding grids
- ▶ Base cladding with screw connection
- ▶ USB storage medium with software and AtmoCONTROL manual
- ▶ the operating instructions at hand
- ▶ Calibration certificate

2.12 Optional accessories

- ▶ USB to Ethernet converter (Fig. 7). This makes it possible to connect the Ethernet connection interface (see page 12) to the USB port of a computer/laptop.
- ▶ Reinforced, sliding steel grids with a loading capacity of 60 kg each
- ▶ Wall jamb with manual and screw connection

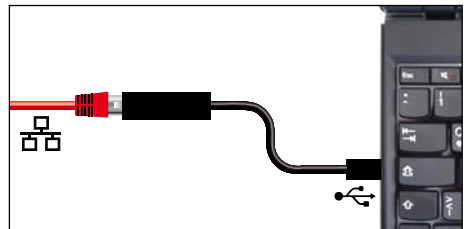

Fig. 7 USB to Ethernet converter

3. Delivery, transport and setting up

3.1 For your safety



⚠ WARNING

There is a risk of injury due to the weight of the appliance if you try to lift it. The appliance may only be transported by a manual pallet jack or forklift truck. Never tilt the appliance. Only transport in upright position and without load (except standard accessories such as steel grids or shelves).



3.2 Delivery

The appliance is delivered on a wooden pallet packed in cardboard.

3.3 Transport

The appliance can be transported in the following ways:

- ▶ With a forklift; direct its forks under the appliance either from the front or from behind (Fig. 8).
- ▶ On a manual pallet jack

3.4 Unpacking

- To avoid damage, do not unpack the appliance until you reach the installation site.

Remove the cardboard packaging by pulling it upwards or carefully cutting along an edge.

3.4.1 Checking for completeness and transport damage

- ▶ Check the delivery note to ensure that the delivery is complete.
- ▶ Check the appliance for damage.

If you notice deviations from the delivery note, damage or irregularities, do not put the appliance into operation but inform the haulage company and the manufacturer.

3.4.2 Remove the transport protection.

Remove the transport protection. It is located between the door hinge, door and frame and has to be removed after opening the door.

3.4.3 Disposing of packaging material

Dispose of the packaging material (cardboard, wood, foil) in accordance with the applicable disposal regulations for the respective material in your country.



Fig. 8 Transporting by forklift

3.5 Storage after delivery

If the appliance is first to be stored after delivery: Read the storage conditions from page 58.

3.6 Setting up



⚠ WARNING

Due to its centre of gravity, the appliance may fall over forwards and injure you or other people. Always screw the appliance firmly to the intended mounting elements on the housing base. In case there is not enough space, do not put the appliance into operation and do not open the door. Contact the Memmert service (see page 2).

3.6.1 Preconditions

The installation site must be flat and horizontal and must be able to reliably bear the weight of the appliance (see “Technical data” on page 14). Do not place the appliance on a flammable surface.

Depending on the model (see nameplate), a 230 V, 115 V or 400 V power connection must be available at the installation site.

Pass-through ovens are intended for wall mounting (Fig. 9). An opening in the wall is required for this. Optionally, jambs can be ordered for protection against contamination of the cleanroom, which additionally seal the wall breakthrough (see supplementary manual jamb installation). The size of the wall opening can be found in the following table:

Appliance	Size of wall opening (W x H in mm; tolerance + 25 mm respectively)
UF160TS	825 x 1255
UF260TS	905 x 1335
UF450TS	1305 x 1255
UF750TS	1305 x 1735

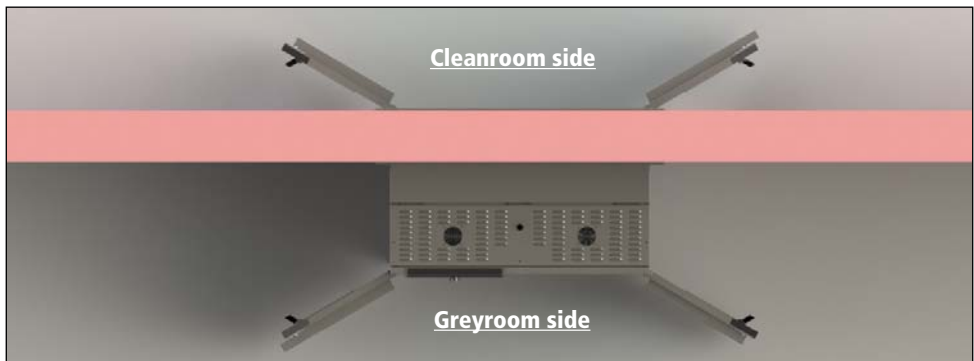

Fig. 9 Mounting in wall opening

Make sure that exhaust air is located on the greyroom side and the supply air opening is on the cleanroom side (Fig. 9). The ControlCOCKPIT must always be located on the greyroom side.

3.6.2 Fastening the appliance

The appliance must be firmly connected to the housing base. Screw it to the housing base by the four feet with two screws per foot (Fig. 10), then screw the front and back cover on (Fig. 11).



Fig. 10 Screw the appliance to the housing base by the adjustable feet



Fig. 11 Screw the cover on

3.6.3 Adjust the doors (only applicable to appliance sizes 450 and 750)

For the appliance sizes 450 and 750, you can adjust the doors if necessary, for example if they are warped due to uneven flooring. There are two adjusting screws each at the top and the bottom of each door for this purpose (Fig. 12).

● First, adjust the setting at the top of the door and, if this is not sufficient, adjust the 1 screws at the bottom of the door.

1. Open the door.
2. Loosen the screws.
3. Adjust the position of the door.
4. Tighten the screws again.
5. Check the position of the door.
6. Readjust if required.

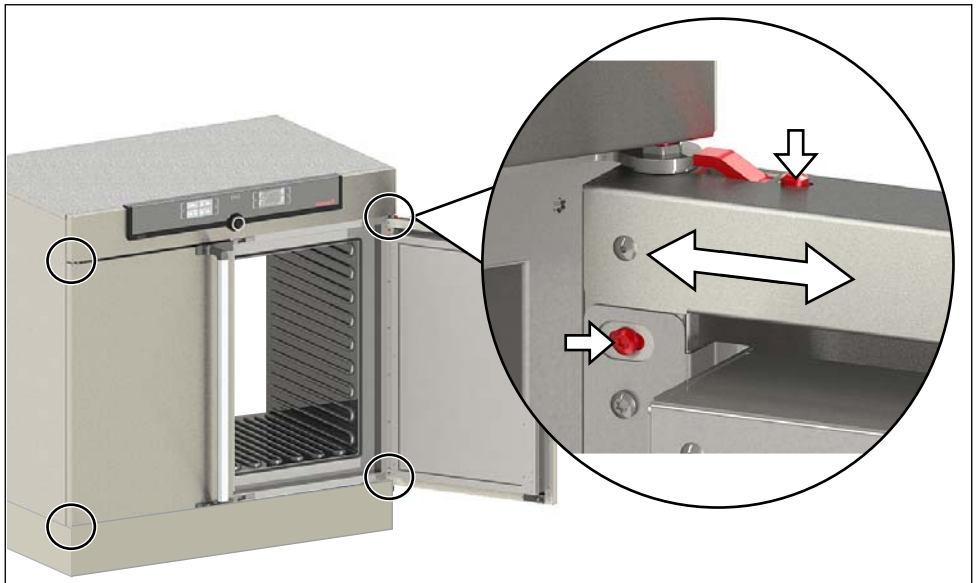

Fig. 12 Adjusting screws for the door

4. Putting into operation

⚠ CAUTION

When operating the appliance for the first time, do not leave it unattended until it has reached a steady state.

4.1 Connecting the appliance

⚠ CAUTION

Observe the country-specific regulations when making connections (e.g. DIN VDE 0100 with earth leakage circuit breaker, in Germany). Observe the connection and power ratings (see nameplate and "Technical data" on page 14). Make sure to establish a safe PE conductor connection.

Place the power cable so that

- ▶ it is easily accessible at all times and can be pulled off quickly, for example in case of interference or an emergency;
- ▶ it does not represent a trip hazard;
- ▶ it cannot come into contact with any hot parts.

230/115 V appliances:

Plug the provided power cable into the rear of the appliance and connect it to a CEE 7/4 socket (Fig. 13).

400 V appliances:

The power cable is permanently installed. Connect the plug to a 400 V CEE coupling (Fig. 14).

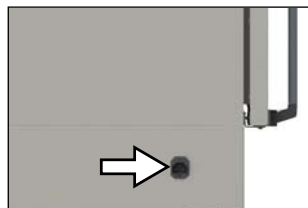

Fig. 13 Power connection
230/115 V



Fig. 14 400 V CEE con-
nection

4.2 Switching on

NOTICE

If equipped with mutual door lock, the doors on both the cleanroom side and the grey-room side have to be closed when switching on. In the initial phase, an actuator extends a locking bolt and locks the doors. If one of the doors is open, the locking bolt does not lock the door properly. This is prevented by an open door sensor.

1. Close the doors.
2. Switch on the appliance by pressing the main switch on the front of the appliance (Fig. 15).

The start-up process is shown by three animated white dots . If the dots are any other colour, an error has occurred (see page 40).

- i** The appliance displays are in English by default after the appliance is switched on for the first time. You can change the language as described from page 43. However, to get a basic overview of operating the appliance, you should read the following chapter first.

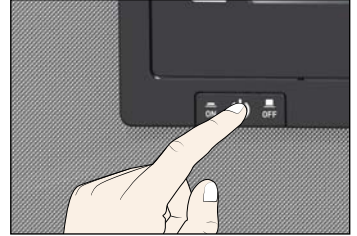

Fig. 15 Switching on the appliance.

5. Operation and control

5.1 Operating personnel

The appliance may only be operated by persons who are of legal age and have been instructed accordingly. Personnel who are to be trained, instructed or who are undergoing general training may only work with the appliance under the continuous supervision of an experienced person.

5.2 Opening the door

- ▶ To open the door, pull the door handle sideways (to the left or to the right, depending on the door version, see Fig. Fig. 16, A) and open the door completely.
- ▶ To close the appliance, push the door closed and push the door handle sideways (B).

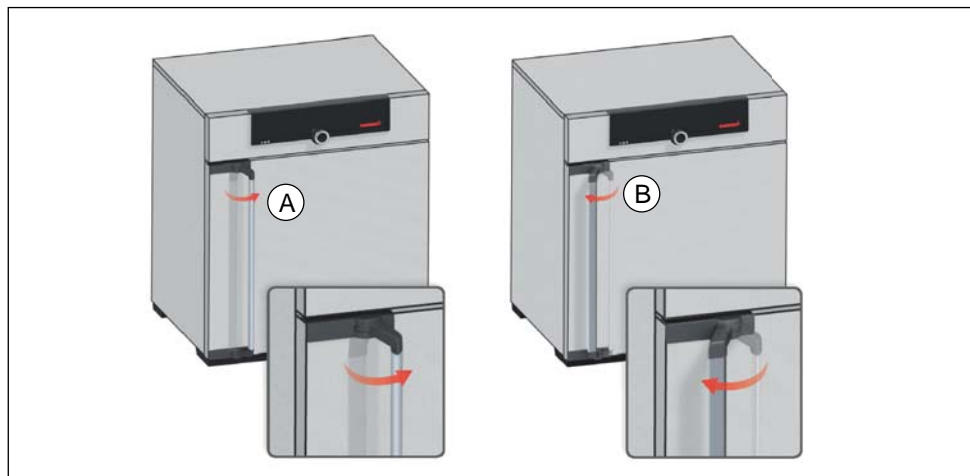

Fig. 16 Opening and closing the door



▲ WARNING

Leaving the door open during operation can cause the appliance to overheat or pose a fire hazard. Do not leave the door open during operation.



▲ WARNING

With appliances above a specific size, you could become accidentally locked inside the appliance, which could put you at risk of death. Do not climb into the appliance!

5.2.1 Process-dependent mutual door lock (optional)

A mutual door lock (optional) prevents both doors from being opened simultaneously, so that no contamination can occur in the cleanroom. In the basic state (no active programme), the door is unlocked on the greyroom side (ControlCOCKPIT side) and locked on the cleanroom side.

Door lock logic in programme mode

Situation	Clean-room	Greyroom
Basic state (no active programme)		
Appliance charged and programme started		
Programme ended properly		
Cleanroom door opened, chamber load taken out and door locked again		
Keep transfer key pressed until cleanroom side is locked and greyroom side is unlocked.		

If equipped with a mutual door lock, the appliance is equipped with a transfer key on the cleanroom side (Fig. 17).

When programme mode is active, the transfer key lights up green. Once a programme has finished, the light flashes and the door on the cleanroom side is unlocked.

Transfer key	Appliance status
Lamp does not light up	Appliance in basic state, no programme active
Lamp remains lit permanently	Appliance in programme mode, programme active
Lamp flashes approximately once every 4 seconds	Appliance in programme mode. programme finished properly

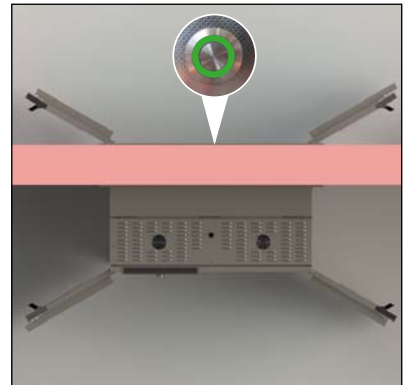

Fig. 17 Transfer key on the cleanroom side

5.3 Loading the appliance



⚠ WARNING

Poisonous or explosive vapours or gases may be produced if the appliance is loaded with an unsuitable load. This could cause the appliance to explode, and people could be severely injured or poisoned. The appliance may only be loaded with materials which do not form any toxic or explosive vapours when heated and cannot catch fire (see also "Intended use" on page 8). If there is any doubt as to the composition of materials, they must not be loaded into the appliance.



i Caution:

Check the chamber load for chemical compatibility with the materials of the appliance (see page 11).

Insert the sliding steel grids or sliding shelves. The maximum number of grids/shelves and the load capacity are specified in the technical data overview from page 14.

Load the chamber leaving enough space between the items so that proper air circulation in the interior is guaranteed. Do not place any of the chamber load on the bottom, touching the side walls or right below the ceiling of the chamber (Fig. 18, see also the "correct loading" sticker on the appliance).

In case of improper loading (not enough space between the items), the set temperature may be exceeded or it may take longer until it is reached.

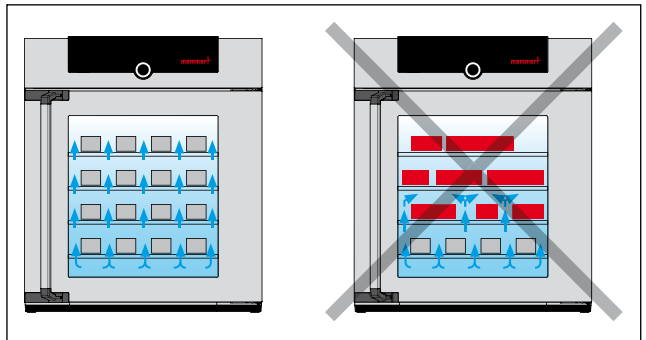

Fig. 18 Correct placement of the chamber load

i To achieve the correct heating capacity, the type of slide-in unit used – grid or shelf – must be set in the menu under **SETUP** (see page 46).

5.4 Operating the appliance

5.4.1 ControlCOCKPIT

In manual mode, the desired parameters are entered in the ControlCOCKPIT on the front of the appliance (Fig. 19). You can also make basic settings here (menu mode). Additionally, warning messages are displayed, e.g. if the temperature is exceeded. In programme mode, the parameters defined, the programme description, the programme segment currently active and programme duration remaining are displayed (for a more detailed description, see page 30).

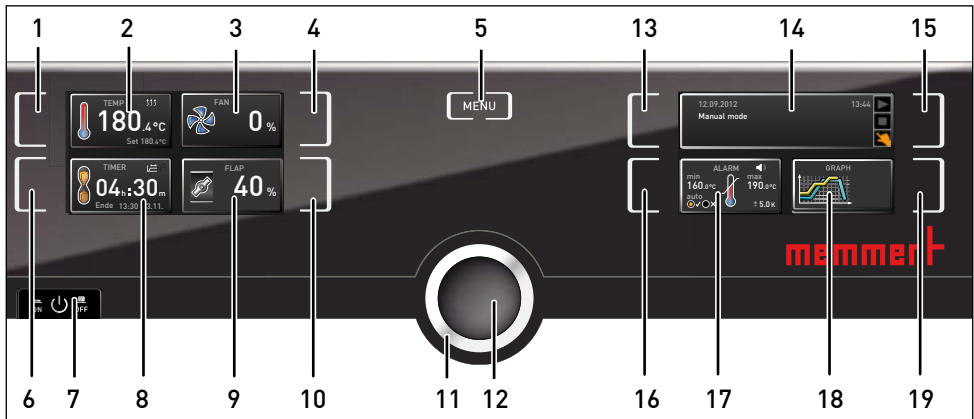

Fig. 19 ControlCOCKPIT for UFTS appliances in operating mode (width may differ, depending on appliance size)

- | | |
|---|--|
| <ol style="list-style-type: none"> 1 Activation key for temperature setpoint adjustment 2 Setpoint and actual temperature display 3 Fan speed display 4 Activation key for fan speed setting 5 Switch to menu mode (see page 42) 6 Activation key digital backwards counter with target time setting, adjustable from 1 minute to 99 days 7 Main switch 8 Display digital backwards counter with target time setting, adjustable from 1 minute to 99 days | <ol style="list-style-type: none"> 9 Air flap position display 10 Activation key for air flap position adjustment 11 Turn control for setpoint adjustment 12 Confirmation key (accepts setting made with the turn control) 13 Activation key for the appliance state 14 Appliance state and programme display 15 Activation key for the appliance state 16 Activation key for temperature monitoring 17 Temperature monitoring display 18 Graphic representation 19 Activation key for graphic representation |
|---|--|

5.4.2 Basic operation

In general, all settings are made according to the following pattern:

1. Activate the desired parameter (e.g. temperature). To do so, press the corresponding activation key on the left or right of the respective display. The activated display is lined in colour, the other displays are dimmed. The set value is highlighted in colour.

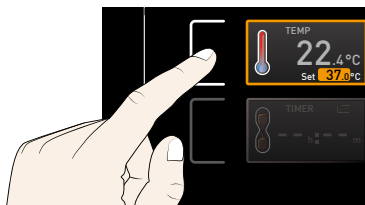

2. By turning the turn control to the left or right, adjust the set value (e.g. to 180.0 °C).



3. Save the set value by pressing the confirmation key. The display returns to normal and the appliance begins adjusting to the defined set value.

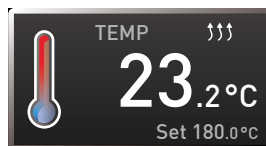
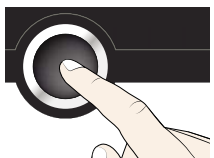

Additional parameters (air flap position etc.) can be set accordingly.

- 1 If no new values are entered or confirmed for approx. 30 seconds, the appliance automatically restores the former values.

If you want to abort the setting procedure, press the activation key on the left or right of the display that you want to exit. The appliance restores the former values. Only the settings that you have confirmed by pressing the confirmation key before cancelling the setting procedure are accepted.

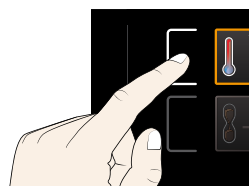

5.4.3 Operating modes

The appliance can be operated in different modes:

- ▶ **Manual mode:** The appliance runs in permanent operation at the values set on the ControlCOCKPIT. Operation in this mode is described in chapter 5.4.4.
- ▶ **Operation with digital backwards counter with target time setting, adjustable from 1 minute to 99 days (timer):** The appliance will run at the values set until the set time has elapsed. Operation in this mode is described in chapter 5.4.5.
- ▶ **Programme mode:** The appliance automatically runs programme sequences which have been defined using AtmoCONTROL software at a computer / laptop and then transferred to the appliance from a USB stick or via Ethernet. Operation in this mode is described in chapter 5.4.6.
- ▶ **By remote control**

The status display shows which operating mode or operating state the appliance is currently in. The current operating state is highlighted in colour and indicated by the text display:

- ▶ Appliance is in programme mode
- Programme is stopped
- ✋ Appliance is in manual mode

The example on the right shows the appliance in manual mode, identified by the coloured hand symbol.

- ▶ When the appliance is in timer mode, **Timer active** is displayed:

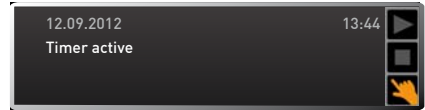

- ▶ If the appliance is in remote control mode, the symbol appears in the temperature display:

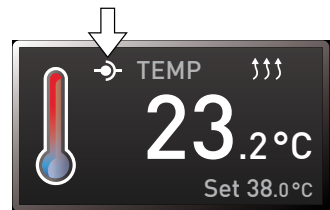

5.4.4 Manual mode

In this operating mode, the appliance runs in permanent operation at the values set on the ControlCOCKPIT.

- In manual and timer mode, the door on the **1** greyroom side (ControlCOCKPIT side) is always unlocked if equipped with mutual door lock and locked on cleanroom side.

Adjustment options

As described in chapter 5.4.2, you can set the following parameters after pressing the corresponding activation key (in any sequence):

Temperature

Adjustment range: model-dependent (see nameplate and technical data on page 14)

- Heating operation is indicated by the symbol.
- 1** You can select °C or °F as the temperature units displayed (see page 45).

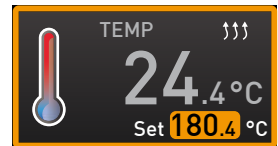

Air flap position

Adjustment range: 0 % (closed, recirculating operation) to 100 % (opened completely, fresh air operation) in steps of 10%

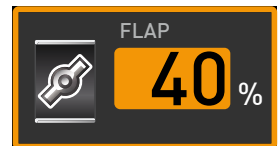

Fan speed

Adjustment range: 0 to 100 % in steps of 10%

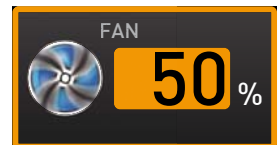

5.4.5 Operation with digital backwards counter with target time setting, adjustable from 1 minute to 99 days (timer)

In timer operation, you can adjust the time the appliance runs at the set values. The appliance has to be in manual operating mode for this.

1. Press the activation key to the left of the timer display. The timer display is activated.

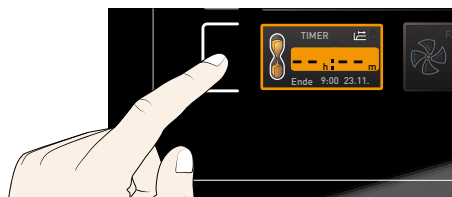

2. Turn the turn control until the desired duration is displayed – in this example 4 hours 30 minutes. The approximate end time is shown beneath, in a smaller font.



- Up to a duration of 23 hours 59 minutes, the time is displayed in hh:mm (hours:minutes) format. For 24 hours and more, the format dd:hh (days:hours) is used. The maximum duration adjustable is 99 days 00 hours.

3. Press the confirmation key to confirm.

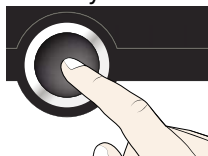

The display now shows the remaining time in a large font and the approximate end time in a smaller font beneath. The status display shows "Timer active".

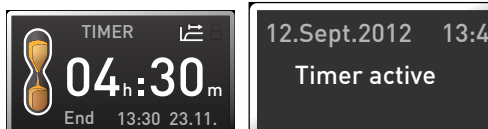

4. Now, as described under 5.4.2, set the individual values for temperature, air flap position etc. which you want the appliance to operate at. The set values can be changed at any time while the timer elapses. The changes are effective immediately.

- In **Setup**, you can choose if the timer should be setpoint-dependent or not. This determines whether the timer should not start until a tolerance band around the set temperature is reached or if it should start immediately after activation (see page 46). The  symbol on the timer display indicates that the timer is set to setpoint-dependent.

Once the timer has finished, the display shows 00h:00m. All functions (heating etc.) are switched off. If a fan was on, it will continue running for a short safety period. In addition, an acoustic alarm sounds, which can be turned off by pressing the confirmation key.

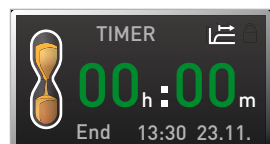

To deactivate the timer, open the timer display by pressing the activation key again and then turning the turn control to reduce the timer setting until --:-- is displayed. Press the confirmation key to confirm.

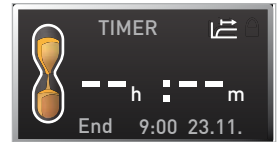

5.4.6 Programme mode

In this operating mode, programmes saved in the appliance can be started with different combinations of individual parameters (temperature, air flap position, fan speed, interior lighting) at staggered intervals, which the appliance then automatically processes in sequence. These programmes are not created directly at the appliance but externally at a computer / laptop and using AtmoCONTROL software. Transfer to the appliance is possible using the provided USB storage medium or via Ethernet.



A description of how to create and save programmes can be found in the separate AtmoCONTROL software manual.

If equipped with mutual door lock, the door lock symbol has to be added with the setting "locked" when starting to create a programme for UFTS in AtmoCONTROL.



Starting a programme

1. Press the activation key on the right of the status display. The current operating mode is highlighted automatically, in this example **Manual mode** ().



2. Turn the turn control until the start symbol is highlighted. The current programme is displayed, in this example **Test 012**.

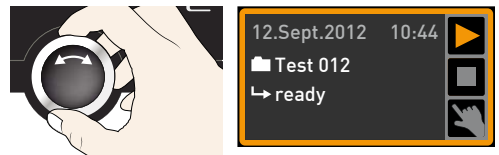

- 1 Only the programme currently selected in menu mode and shown in the display can be used. If you want to process another programme, you need to activate it in menu mode first (see description starting on page 51).

3. To start the programme, press the confirmation key. The programme is activated. The display shows:

- ▶ the programme description (in this example **Test 012**)
- ▶ the programme segment description, in this example **Ramp 1**
- ▶ the current run (in case of loops)

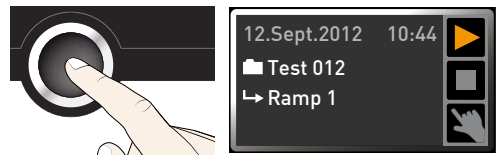

- 1 You cannot change any parameters (e.g. the temperature) at the appliance while a programme is running. However, the displays **ALARM** and **GRAPH** can still be used. If equipped with mutual door lock, the door on greyroom side is locked when starting the programme, so that both doors are locked. This process can last up to four seconds. The transfer key on the cleanroom side lights up green for the entire duration of the programme.



Cancel programme

You can cancel an active programme at any time.

1. Press the activation key to the right of the status display. The status display is automatically highlighted.
2. Turn the turn control until the ■ stop symbol is highlighted.
3. Press the confirmation key to confirm. The programme is cancelled.

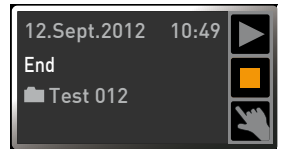
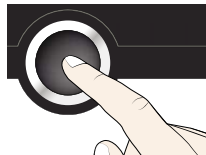
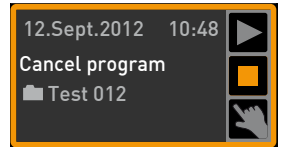
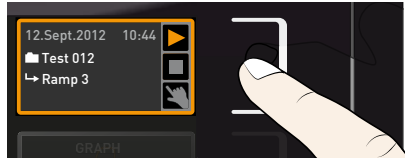

- 1 A cancelled programme cannot be resumed at the point it was cancelled. It must be restarted from the beginning. If a programme is cancelled before it has ended properly, the cleanroom side is locked, if equipped with mutual door lock, and the greyroom side is unlocked.

End of programme

End is shown on the display to indicate that the programme has finished.

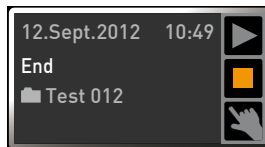

If equipped with mutual door lock, the door on the cleanroom side unlocks after the programme has finished and the transfer key flashes. The door on the greyroom side remains locked.

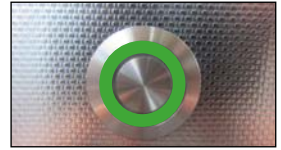

The door on the cleanroom side can now be opened. To lock the cleanroom side again, press the transfer key until the locking knob goes down. This causes the door on the cleanroom side to lock and the door on the greyroom side is unlocked after approx. 4 seconds. This prevents both doors from being opened simultaneously.



You can now

- ▶ restart the programme as described
- ▶ select another programme to run in menu mode (see page 51) and run it as described.
- ▶ Return to manual mode. To do so, reactivate it by pressing the activation key next to the status display, then turn the turn control until the hand symbol is highlighted and press the confirmation key.

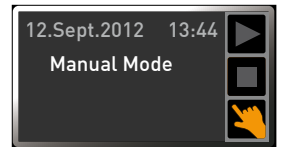

5.5 Temperature monitoring

The appliance is equipped with multiple overtemperature protection (mechanical/electronic) in accordance with DIN 12 880. This serves to avoid damage to the chamber load and/or appliance in case of a malfunction:

- ▶ electronic temperature monitoring (TWW/TWB)
- ▶ automatic temperature monitor (ASF)
- ▶ mechanical temperature limiter (TB)

The monitoring temperature of the electronic temperature monitoring is measured via a separate PT100 temperature sensor in the chamber. Temperature monitoring settings are made via the **ALARM** display. The settings made apply to all operating modes.

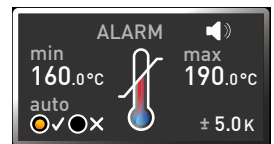

If temperature monitoring has been triggered, this is indicated on the temperature display: the actual temperature is highlighted in red and a warning symbol is shown (Fig. 20). The type of temperature monitoring triggered (TWW in this example) is shown beneath the temperature.

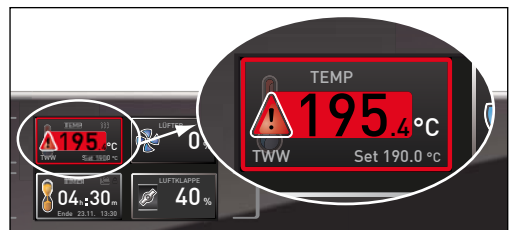



Fig. 20
Temperature monitoring triggered

If the acoustic alarm has been activated in menu mode (Sound see page 53, indicated by the speaker symbol  on the alarm display), the alarm is additionally signalled by an intermittent acoustic signal, which can be turned off by pressing the confirmation key. Information on what to do if this happens can be found in chapter Malfunctions, warning and error messages from page 38.

Before reading how to adjust temperature monitoring (from page 35), please read the description of the individual monitoring functions here.

5.5.1 Electronic temperature monitoring (TWW)

The manually set monitoring temperature **min.** and **max.** of the electronic overtemperature control is monitored by an adjustable over/undertemperature controller (TWW) protection class 3.1 acc. to DIN 12 880 (or over/undertemperature controller (TWW) protection class 3.1 for UIS appliances). If the manually set monitoring temperature **max** is exceeded, the TWW takes overtemperature control and begins to regulate the monitoring temperature (Fig. 21).

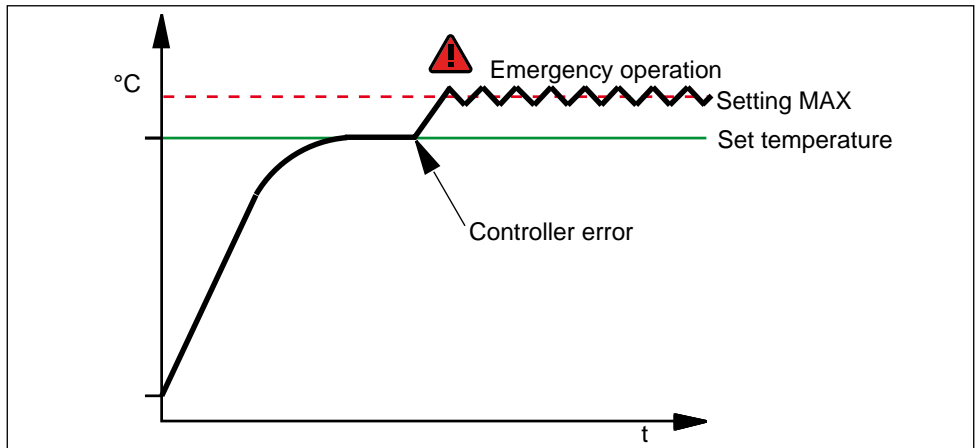

Fig. 21 Schematic diagram of how TWW temperature monitoring works

5.5.2 Electronic temperature limiter (TWB) protection class 2 acc. to DIN 880

If the manually set monitoring temperature **max** is exceeded, the TWB switches off heating permanently (Fig. 22) and can be reset by pressing the confirmation key.

- In programme mode, the current programme is resumed for TWB alarms of up to 15 minutes. If the alarm is active for more than 15 minutes, the programme is cancelled.

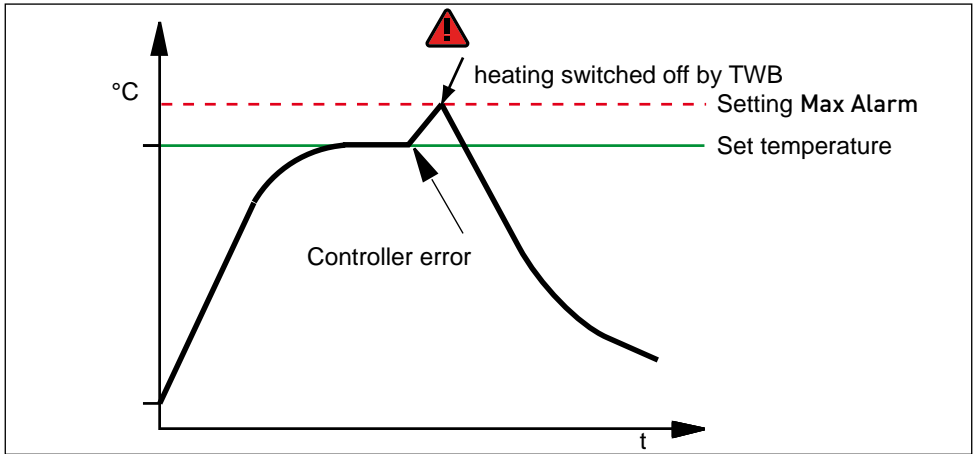

Fig. 22 Schematic diagram of how the TWB temperature monitoring works

5.5.3 Automatic temperature monitor (ASF)

ASF is a monitoring device that automatically follows the set temperature setpoint within an adjustable tolerance band (Fig. 23).

The ASF – if switched on – is automatically activated as soon as the actual temperature value reaches 50 % of the set tolerance band of the setpoint (in the example: 180 °C - 1.5 K) for the first time (section A).

When the temperature violates the set tolerance band around the setpoint (in the example in Fig. 23:

180 °C ± 3 K) – e.g. if the door is opened during operation (section B of illustration) – the alarm is set off. The ASF alarm is automatically terminated as soon as 50 % of the set tolerance band of the setpoint (in the example: 180 °C ± 1.5 K) are reached again (section C).

If the temperature setpoint is altered, the ASF is automatically disabled temporarily (in this example: The setpoint is changed from 180 °C to 173 °C, section D), until it reaches the tolerance range of the new temperature setpoint (section E).

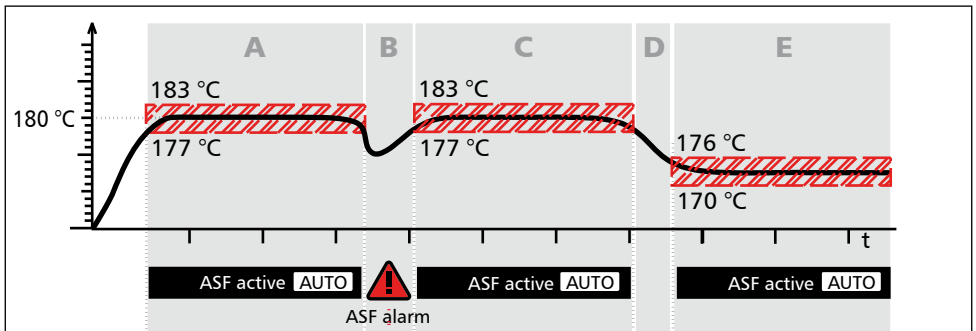

Fig. 23 Schematic diagram of how the ASF temperature monitoring works

5.5.4 Mechanical temperature monitoring: Temperature limiter (TB)

The appliance is equipped with a mechanical temperature limiter (TB) of protection class 1 in accordance with DIN 12 880.

If the electronic monitoring unit should fail during operation and the factory-set maximum temperature is exceeded by approx. 20 °C, the temperature limiter, as the final protective measure, switches off the heating permanently.

5.5.5 Adjusting temperature monitoring

1. Press the activation key to the left of the **ALARM** display. The min setting (undertemperature protection) is automatically activated.

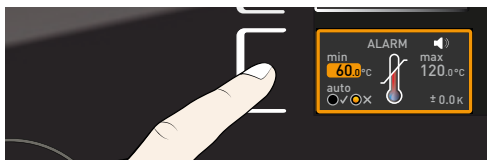

2. By turning the turn control, adjust the desired lower alarm limit value, in the example on the right 160 °C.

i If no undertemperature protection limit is required, set the lowest temperature.

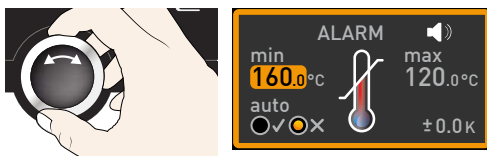

3. Press the confirmation key to confirm. The max display (overtemperature protection) is activated.



4. By turning the turn control, adjust the desired upper alarm limit value, in the example on the right 190 °C.

i The monitoring temperature must be set sufficiently high above the maximum set temperature. We recommend 5 to 10 K.

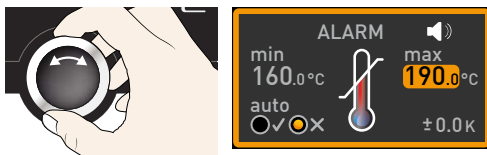

5. Accept the upper alarm limit value by pressing the confirmation key. The setting of the automatic temperature monitor (ASF) is automatically activated (auto).

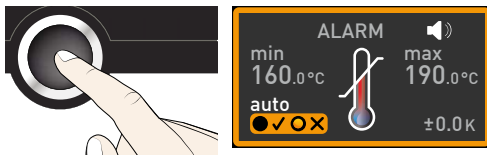

6. With the turn control, select ON (✓) or OFF (✗).

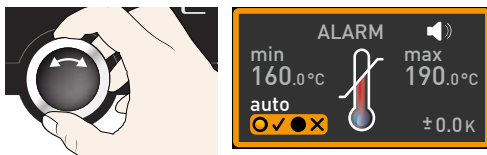

- Press the confirmation key to confirm. The ASF tolerance band setting is activated.

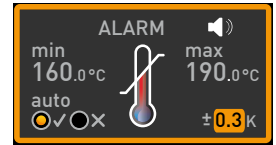
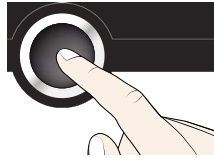

- With the turn control, adjust the desired tolerance band, e.g. 5.0 K.

i We recommend a tolerance band of 5 to 10 K.

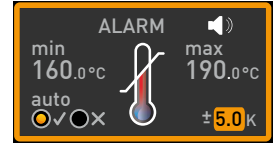
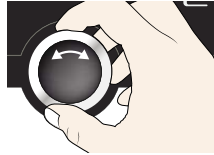

- Press the confirmation key to confirm. Temperature monitoring is now active.

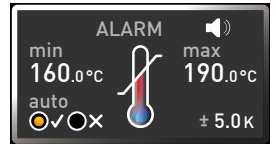
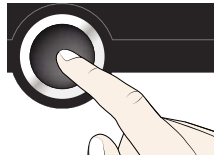

In menu mode, you can:

- ▶ Which type of protection (TWW or TWB) is required (see page 45)
- ▶ If an acoustic signal should be triggered in the event of an alarm (see page 53)

5.6 Graph

The GRAPH display provides an overview of the chronological sequence of the set temperature values and the actual temperature values as a graph.

- Press the activation key to the right of the GRAPH display. The display is enlarged and the temperature profile shown.

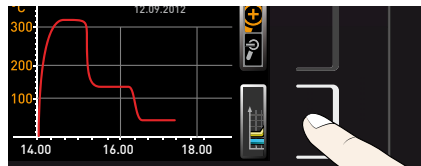

- ▶ To change the time frame to be displayed: Press the activation key next to the $\triangleleft \triangleright$ arrow symbols. The time frame to be displayed can now be changed by turning the turn control.

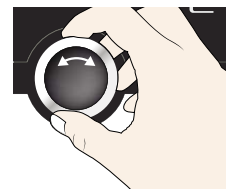
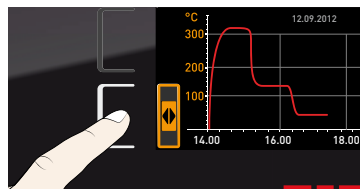

- ▶ To zoom the graph in or out: Press the activation key next to the magnifying glass symbol. With the turn control, select if you want to zoom in or out (+/-) and confirm your selection by pressing the confirmation key.



To close the graphical representation, press the activation key you used to activate it again.

5.7 Ending operation



▲ WARNING

Depending on operation, the surfaces in the working chamber and the chamber load may still be very hot after the appliance is switched off. Touching these surfaces can cause burns. Wear heat-resistant protective gloves or wait until the appliance cools down first.



1. Switch off active appliance functions (turn back the set values).
2. Remove the chamber load.
3. Switch off the appliance with the main switch (Fig. 24).

If equipped with mutual door lock, the door on the greyroom side (Control-COCKPIT side) is always unlocked and the door on cleanroom side is locked.

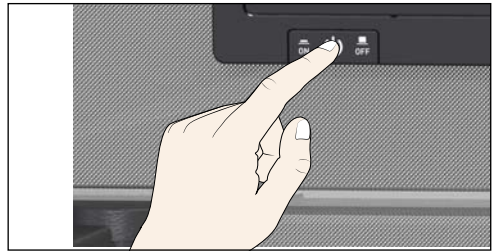

Fig. 24 Switching off the appliance.

6. Malfunctions, warning and error messages



⚠ WARNING

After removing covers, live parts may be exposed. Touching these can lead to an electrical shock. Malfunctions requiring work inside the appliance may only be rectified by electricians. Observe the separate service manual for this.

Do not try to rectify appliance errors yourself but contact the MEMMERT customer service department (see page 2) or an authorised service point.

In case of enquiries, please always specify the model and appliance number given on the nameplate (see page 13).

6.1 Warning messages of the monitoring function

- If the acoustic alarm has been activated in the menu mode (Sound, see page 53, indicated by the speaker symbol  in the alarm display), the alarm is additionally signalled by an intermittent acoustic signal. If the confirmation key is pressed, the acoustic alarm can be temporarily switched off until the next alarm event occurs.



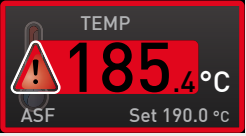
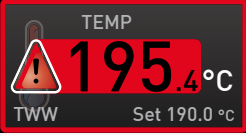

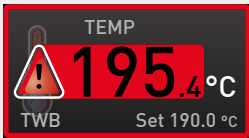
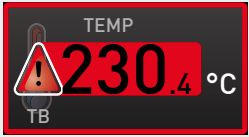
6.1.1 Temperature monitoring

Description	Cause	Action	See
Temperature alarm and "ASF" are displayed 	Automatic temperature monitor (ASF) was triggered.	Check if the door is closed. Close the door. Extend the ASF tolerance band If the alarm continues: Contact customer service	Page 34 Page 2
Temperature alarm and "TWW" are displayed 	The adjustable temperature controller (TWW) has assumed heating control.	Increase the difference between the monitoring and setpoint temperature – by either increasing the max value of the temperature monitoring or decreasing the setpoint temperature. If the alarm continues: Contact customer service	Page 35 Page 2

Description	Cause	Action	See
Temperature alarm and "TWB" are displayed 	The electronic temperature limiter (TWB) permanently switched off heating.	Deactivate the alarm by pressing the confirmation key. Increase the difference between the monitoring and setpoint temperature – by either increasing the max value of the temperature monitoring or decreasing the setpoint temperature. If the alarm continues: Contact customer service	Page 35 Page 2
Temperature alarm and "TB" are displayed 	The mechanical temperature limiter (TB) permanently switched off heating.	Switch off the appliance and leave to cool down. Contact customer service and have the error rectified (e.g. by replacing the temperature sensor).	Page 2

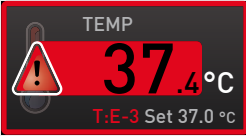
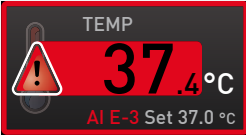
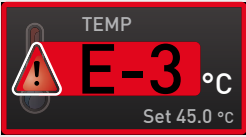
6.2 Malfunions, operating problems and appliance errors

Error description	Cause of errors	Rectifying errors	See
Displays are dark	External power supply was interrupted	Check the power supply	Page 21
	Miniature fuse, appliance fuse or power module faulty	Contact customer service	Page 2
Displays cannot be activated	Appliance locked by USER ID	Unlock with USER ID	Page 55
	The appliance is in programme, timer or remote control mode (mode "Write" or "Write + Alarm")	Wait until the end of the programme or timer mode or switch off the remote control	
Displays suddenly look different	Appliance is in "wrong" mode	Change to operating or menu mode by pressing the MENU key	
Door cannot be opened	Door has been locked automatically to protect the cleanroom from contamination	Observe the locking logic	Page 24

Error description	Cause of errors	Rectifying errors	See
<p>Error message T:E-3 in the temperature display</p> 	<p>Temperature operating sensor is defective. The monitoring sensor takes over the measurement function.</p>	<ul style="list-style-type: none"> ▶ The appliance can temporarily be kept in service ▶ Contact customer service as soon as possible 	<p>Page 2</p>
<p>Error message AI E-3 in the temperature display</p> 	<p>Temperature monitoring sensor is defective. The operating sensor takes over the measurement function.</p>	<ul style="list-style-type: none"> ▶ The appliance can temporarily be kept in service ▶ Contact customer service as soon as possible 	<p>Page 2</p>
<p>Error message E-3 in the temperature display</p> 	<p>Operating and monitoring sensor defective</p>	<ul style="list-style-type: none"> ▶ Switch off appliance ▶ Remove the chamber load ▶ Contact customer service 	<p>Page 2</p>
<p>When switching on the appliance, the start animation is displayed in another colour than white</p> 	<ul style="list-style-type: none"> ▶ Cyan : Insufficient storage space on the SD card ▶ Red : The system files could not be loaded ▶ Orange : The fonts and images could not be loaded 	<p>Contact customer service</p> <p>Contact customer service</p> <p>Download the firmware update from memmert.com and install it</p>	<p>Page 2</p> <p>Page 2</p>

6.3 Power failure

**▲ WARNING**

Depending on the operation performed, the surfaces inside the chamber and the chamber load may still be very hot after power failure. Additionally, depending on the duration of the power loss, the appliance might heat up again after power supply has been restored (see below). Touching these surfaces can cause burns. Wear heat-resistant protective gloves or wait until the appliance cools down first.

In case of a power failure, the appliance operates as follows:

In manual mode

After power supply has been restored, operation is continued with the parameters set. The time and duration of the power failure are documented in the log memory.

In timer or programme mode

In case of an interruption of the power supply of less than 60 minutes, the current programme is continued from the point at which it was interrupted. For interruptions of the power supply longer than this, all appliance functions (heating, fan etc.) are switched off and the air flap is opened.

In remote control mode

The previous values are restored. If a programme has been initiated via remote control, it is continued.

7. Menu mode

In menu mode, you can make basic settings, load programmes and export protocols, as well as adjust appliance parameters.

Caution:

1 Before changing menu settings, read the description of the respective functions on the following pages to avoid possible damage to the appliance and/or chamber load.

To enter menu mode, press the MENU key.

1 To exit the menu mode at any time, press the MENU key again. The appliance then returns to operating mode. Only changes accepted by pressing the confirmation key are saved.

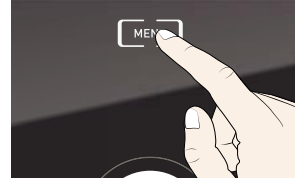

7.1 Overview

Press the MENU key to change between the displays in menu mode:

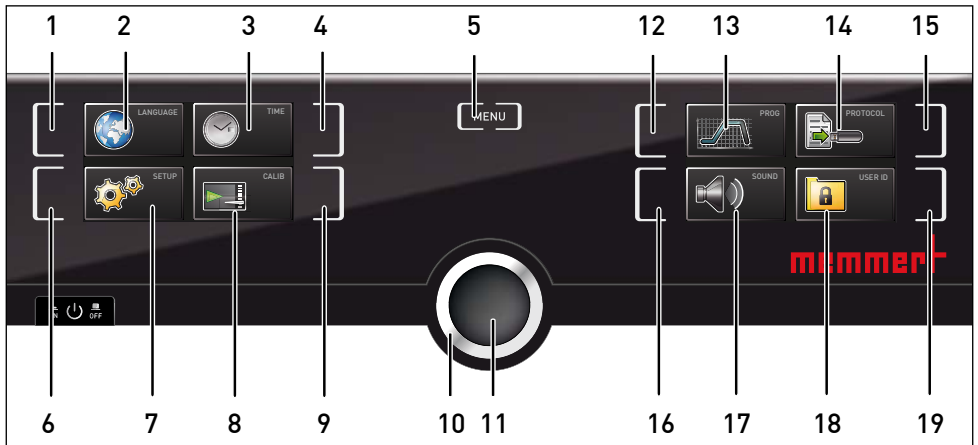

Fig. 25 ControlCOCKPIT in menu mode

- | | |
|---|--|
| <ul style="list-style-type: none"> 1 Language selection activation key 2 Language selection display 3 Date and time display 4 Date and time setting activation key 5 Exit menu mode and return to operating mode 6 Setup activation key (basic appliance settings) 7 Setup display (basic appliance settings) 8 Adjustment display 9 Adjustment activation key 10 Turn control for adjustment | <ul style="list-style-type: none"> 11 Confirmation key (accepts setting made with the turn control) 12 Programme selection activation key 13 Programme selection display 14 Protocol display 15 Protocol activation key 16 Acoustic signal adjustment activation key 17 Acoustic signal adjustment display 18 USER ID display 19 USER ID display activation key |
|---|--|

7.2 Basic operation in menu mode using the example of language selection

In general, all settings in menu mode are done just like in operating mode: Activate the respective display, use the turn control for setting and press the confirmation key to accept the change. A more detailed description is provided in the following, using the example of language selection.

1. Activate the desired parameter (in this example the language). To do so, press the corresponding activation key on the left or right of the respective display. The activated display is enlarged.

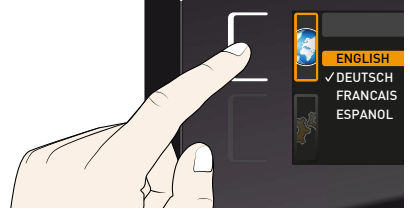

- 1 **i** If you want to exit or cancel the settings, again press the activation key which you have used to activate the display. The appliance returns to the menu overview. Only the settings that you have confirmed by pressing the confirmation key before cancelling the setting procedure are accepted.

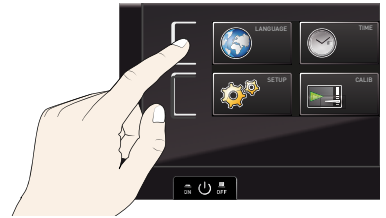

2. Select the desired new setting, e.g. Spanish (ESPANOL) using the turn control.

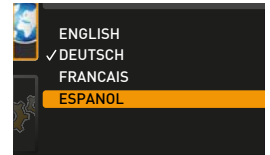

3. Save the setting by pressing the confirmation key.

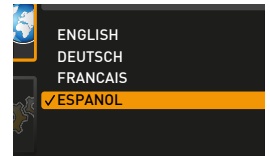
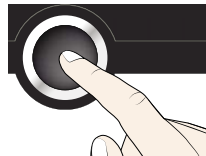

4. To return to the menu overview, press the activation key again.



You can now

- ▶ activate another menu function by pressing the corresponding activation key or
- ▶ return to operating mode by pressing the MENU key.

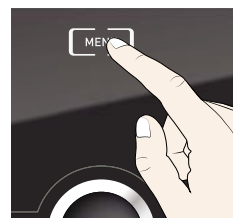
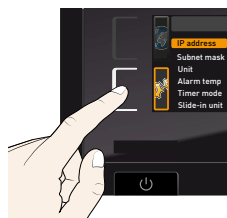

All other settings can be made accordingly. The settings possible are described in the following sections.

- If no new values are entered or confirmed for approx. 30 seconds, the appliance automatically restores the former values.

7.3 Setup

7.3.1 Overview

In the **SETUP** display, you can set the following parameters:

- ▶ the IP address and subnet mask of the appliance's Ethernet interface (for connection to a network)
- ▶ The units of the temperature display (°C or °F, see page 45)
- ▶ **Alarm Temp**: the temperature protection class according to DIN 12 880:2007-5 (TWW or TWB, see pages 45 and 46)
- ▶ How the digital backwards counter with target time setting works (**Timer mode**, see page 46)
- ▶ The type of slide-in unit (steel grid or shelf, see page 46)
- ▶ The heat output distribution (**Balance**, see page 47)
- ▶ Remote control (see page 47)
- ▶ Gateway (see page 48)

- If the Setup menu contains more entries than can be displayed, this is indicated by the display "1/2". This means that there is a second "page" of entries.

To display the hidden entries, use the turn control to scroll beyond the lowest entry. The page display changes to "2/2".

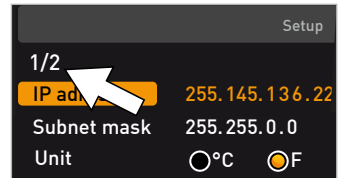

7.3.2 IP address and subnet mask

If you want to operate one or more appliances in a network, each appliance must have its own unique IP address for identification. By default, each appliance is delivered with the IP address 192.168.100.100.

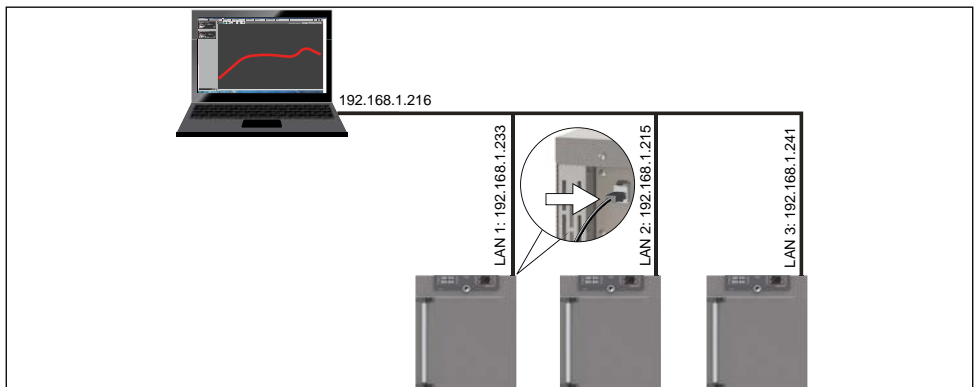
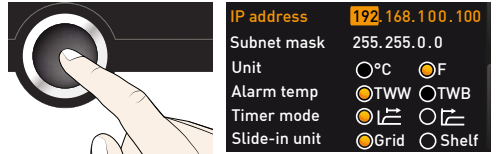

Fig. 26 Operation of several appliances in a network (schematic example)

1. Activate the **SETUP** display. The entry **IP address** is automatically high-lighted.



2. Accept the selection by pressing the confirmation key. The first three digits of the IP address are automatically selected.



3. With the turn control, set the new number, e.g. 255.



4. Accept the selection by pressing the confirmation key. The next three digits of the IP address are automatically selected. Setting these is done according to the description above.

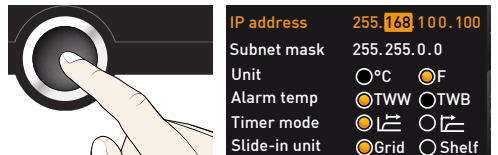

5. After setting the last three digits, accept the new IP address by pressing the confirmation key. The selection returns to the overview. The subnet mask is set accordingly.

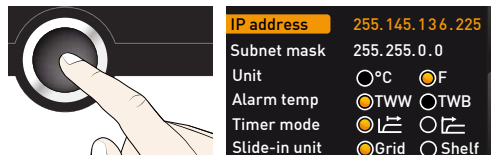

7.3.3 Unit

Here, you can choose whether the temperature is displayed in °C or °F.

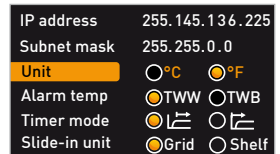

7.3.4 Temperature monitoring (Alarm Temp)

Here, you can select which temperature protection class in accordance with DIN 12 880:2007-5 should be used (TWW or TWB, description from page 33).

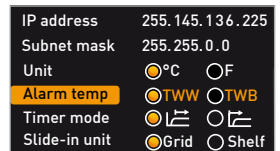

7.3.5 Timer mode

Here, you can choose whether the digital backwards counter with target time setting (see page 29, timer) should be setpoint-dependent or not – this determines whether the timer should not start until a tolerance band of ± 3 K around the set temperature is reached (Fig. 27, B) or whether it should start immediately after activation (A).

IP address	255.145.136.225	
Subnet mask	255.255.0.0	
Unit	<input checked="" type="radio"/> °C	<input type="radio"/> °F
Alarm temp	<input type="radio"/> TWW	<input checked="" type="radio"/> TWB
Timer mode	<input checked="" type="radio"/>	<input type="radio"/>
Slide-in unit	<input checked="" type="radio"/> Grid	<input type="radio"/> Shelf

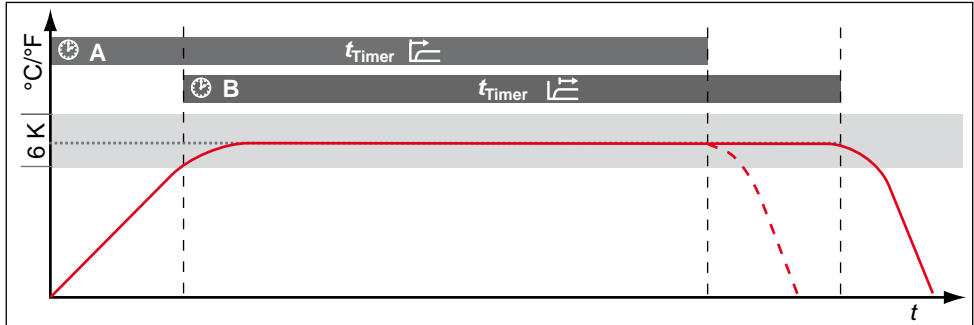

Fig. 27 Timer mode

A Timer independent of setpoint: Timer starts immediately after activation

B Timer setpoint-dependent: Timer does not start until tolerance band is reached

- If the temperature tolerance band is exceeded in setpoint-dependent mode, the timer will be interrupted and only be resumed when the setpoint temperature is reached again.

7.3.6 Type of slide-in unit (steel grid or shelf)

Here, you have to set the type of slide-in unit (steel grid or shelf) used. The selection **Shelf** enables you to adjust the control function to the different air flow characteristics in the chamber when using optional sliding shelves instead of the steel grids that are provided as standard.

IP address	255.145.136.225	
Subnet mask	255.255.0.0	
Unit	<input checked="" type="radio"/> °C	<input type="radio"/> °F
Alarm temp	<input type="radio"/> TWW	<input checked="" type="radio"/> TWB
Timer mode	<input checked="" type="radio"/>	<input type="radio"/>
Slide-in unit	<input checked="" type="radio"/> Grid	<input type="radio"/> Shelf

7.3.7 Balance

For appliances of the size 55 and above, application-specific correction of the heat output distribution (balance) between the upper and lower heating groups is possible. The adjustment range is from -50 % to +50 %.

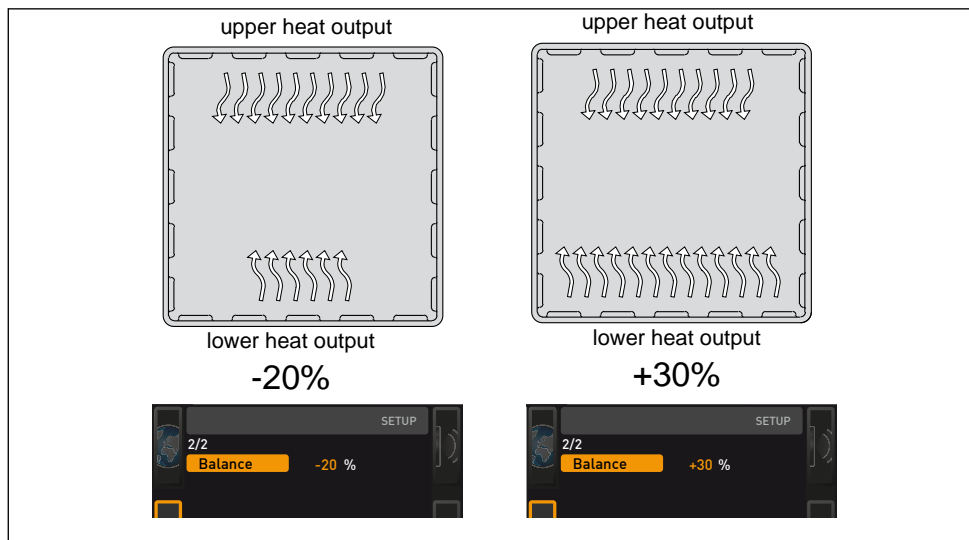



Fig. 28 Heat output distribution (example): The -20 % (left) setting causes the lower heating groups to emit 20 % less heat than the upper ones. The +30 % (right) setting causes the lower heating groups to emit 30 % more heat than the upper ones. The 0 % setting restores the default heat output distribution.

7.3.8 Remote control

In the setup entry remote control, you can set whether the appliance should be controlled via remote control and if so, in which mode. These settings are available:

- ▶ Off
- ▶ Read only
- ▶ Write
- ▶ Write + Alarm

If the appliance is in remote control mode, the  symbol is displayed on the temperature display: In the settings **Write** and **Write + Alarm**, the appliance cannot be controlled at the ControlCOCKPIT until the remote control has been switched off (setting **Off**) or set to **Read only**.

 In order to use the remote control function, programming skills and special libraries are required.

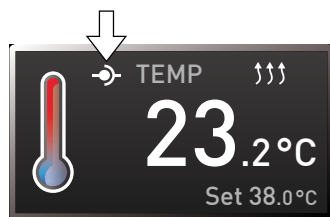
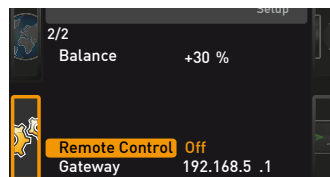

7.3.9 Gateway

The setup entry gateway is used to connect two networks with different protocols.

The gateway is set the same way as the IP address (see page 44).

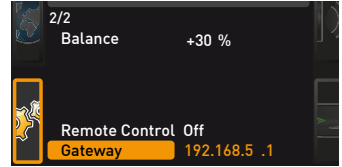

7.4 Date and time

In the **TIME** display, you can set the date and time, time zone and daylight saving time.

1 Always set the time zone (and daylight saving time yes/no) before setting the date and time. Avoid changing the set time after that since this can lead to gaps or overlapping when recording measured values. If you still need to change the time, you should not run a programme immediately before or after doing so.

1. Activate the time setting. To do so, press the activation key on the right side of the **TIME** display. The display is enlarged and the first adjustment option (**Date**) automatically highlighted.

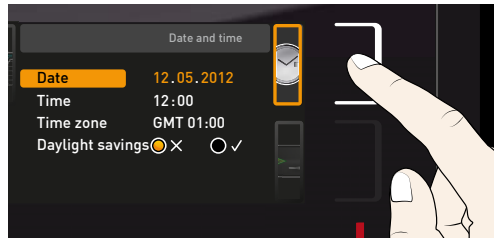

2. Turn the turn control until **Time zone** is highlighted.

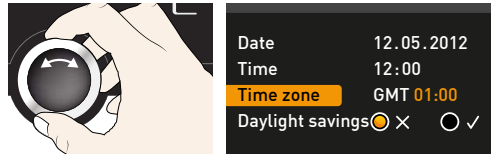

3. Accept the selection by pressing the confirmation key.

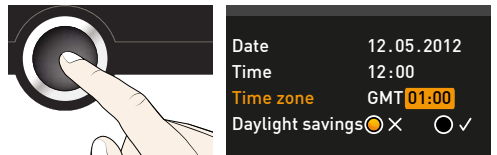

4. Set the time zone of the installation site with the turn control, e.g. 00:00 for France, Spain or Great Britain and 01:00 for Germany. Accept the selection by pressing the confirmation key.

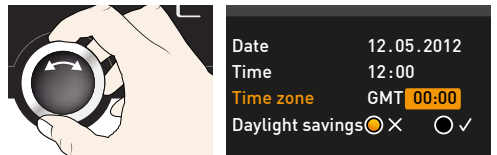

5. Select the **Daylight savings** entry using the turn control.

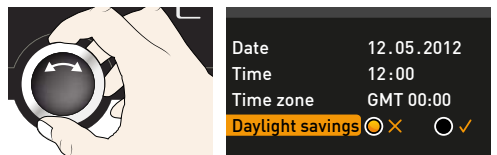

6. Accept the selection by pressing the confirmation key. The adjustment options are highlighted.

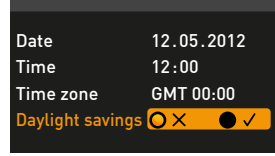
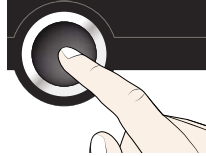

7. Set daylight savings to off (X) or on (✓) with the turn control – in this case on (✓). Save the setting by pressing the confirmation key.

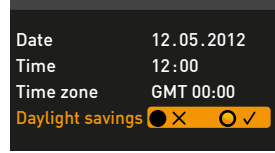

i Daylight saving time and standard time are not changed automatically. For this reason, please keep in mind to adjust them at the beginning of each period.

8. Now, set date (day, month year) and time (hours, minutes) in the same way. Accept the selection by pressing the confirmation key.

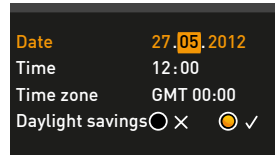

7.5 Calibration

The appliances are temperature calibrated and adjusted at the factory. In case readjustment should be necessary later on – for example due to influence of the chamber load – the appliance can be calibrated customer-specifically using three calibration temperatures of your choice:

- ▶ Cal1 Temperature calibration at low temperature
- ▶ Cal2 Temperature calibration at medium temperature
- ▶ Cal3 Temperature calibration at high temperature

To guarantee perfect control, we recommend to calibrate the appliance once a year.

i For temperature adjustment, you will need a calibrated reference measuring device.

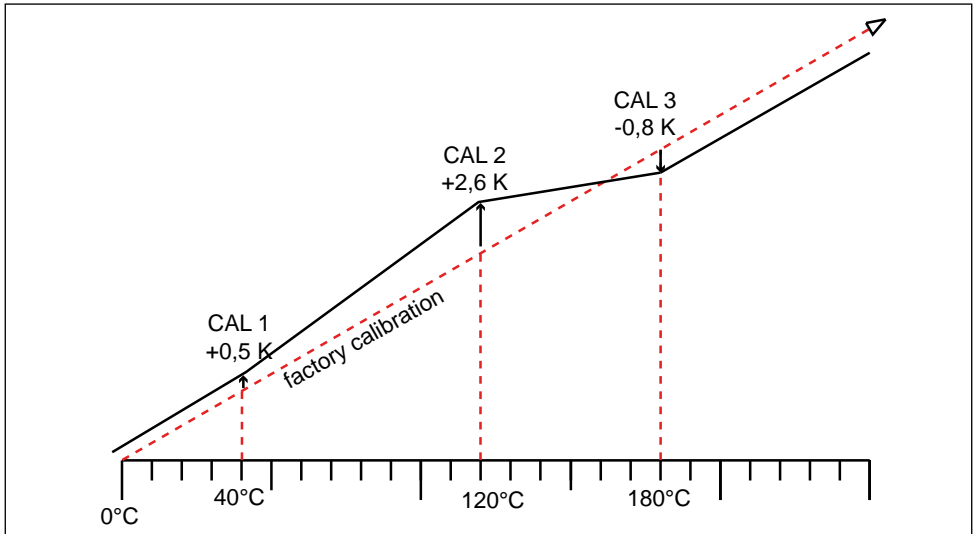
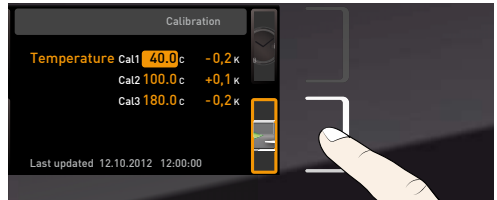

Fig. 29 Schematic example of temperature adjustment

Example: Temperature deviation at 120 °C should be corrected.

1. Activate the adjustment setting. To do so, press the activation key on the right of the **TIME** display. The display is enlarged and the first calibration temperature – in this case 40 °C – automatically highlighted.



2. Press the confirmation key repeatedly, until the calibration temperature Cal2 is selected.

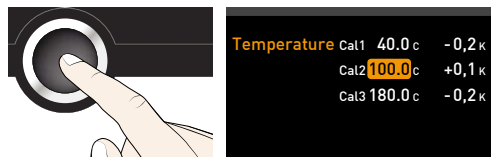

3. With the turn control, set the calibration temperature Cal2 to 120 °C.

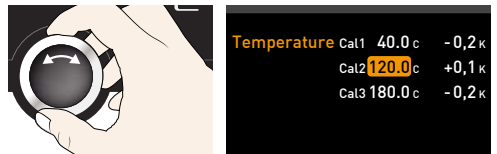

4. Save the setting by pressing the confirmation key. The corresponding calibration value is automatically highlighted.

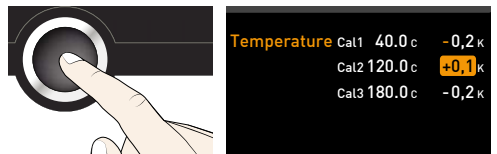

- Set the calibration value to 0.0 K and accept the setting by pressing the confirmation key.

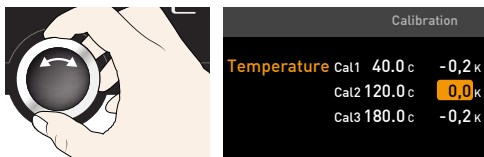

- Position the sensor of a calibrated reference instrument centrally in the appliance's working chamber.
- Close the door and, in manual mode, adjust the set temperature to 120 °C.

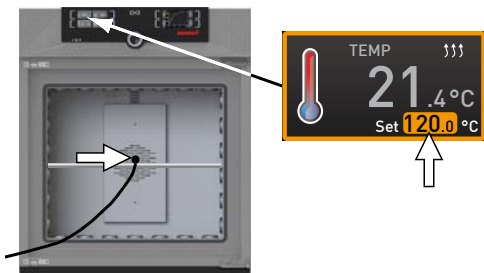

- Wait until the appliance reaches the set temperature and displays 120 °C. The reference instrument should display 122.6 °C.



- In the SETUP, adjust the calibration value Cal2 to +2.6 K (actual value measured minus setpoint temperature) and save the setting by pressing the confirmation key.

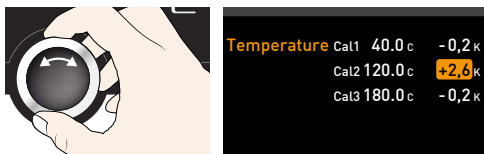

- After the calibration procedure, the temperature measured by the reference instrument should now also be 120 °C.

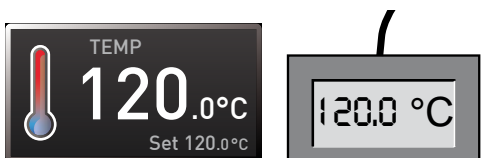

With Cal1, a calibration temperature below Cal2 can be programmed accordingly, and with Cal3, a temperature above. The minimum interval between the Cal values is 20 K.

i If all calibration values are set to 0.0 K, the factory calibration settings are restored.

7.6 Programme

In the Prog display, programmes created using the AtmoCONTROL software can be transferred to the appliance and saved on a USB data storage medium. Here, you can also select the programme to be used in manual mode (see page 30) and delete programmes.

i If equipped with mutual door lock, the door lock symbol has to be added with the setting "Locked" when starting to create a programme for UFTS in AtmoCONTROL.



To load a programme from a USB data storage medium : Connect the USB storage medium with the saved programme(s) to the interface on the right side of the ControlCOCKPIT.

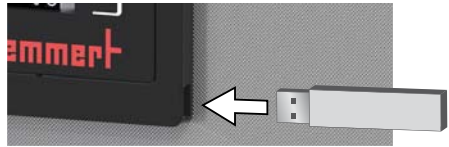

1. Activate the programme display. To do so, press the activation key on the left of the Prog display. The display is enlarged and the entry **Select** automatically highlighted. The programmes available for activation are shown on the right. The programme currently available for use – in this example **Test 012** – is highlighted in orange.

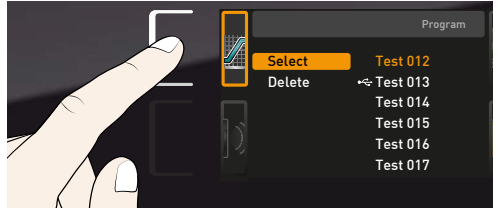

2. Access the **Select** function by pressing the confirmation key. All programmes available are displayed, including the ones saved on the USB data storage medium (identified by the USB symbol). The programme currently available for use is highlighted in orange.

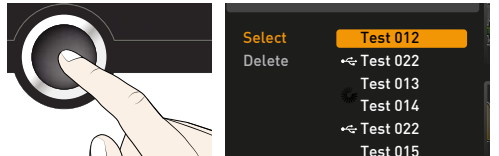

3. With the turn control, select the programme you want to make available for use.

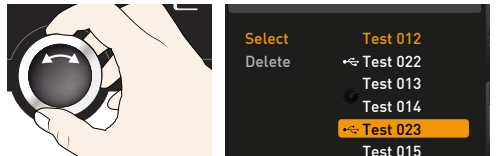

4. Accept the selection by pressing the confirmation key. The programme is now loaded, which is indicated by the transfer symbol.

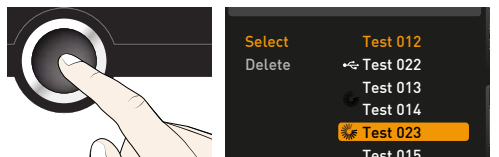

5. As soon as the programme is ready, the selection returns to **Select**. To start the programme: Return to operating mode by pressing the MENU key, as described on page 30.

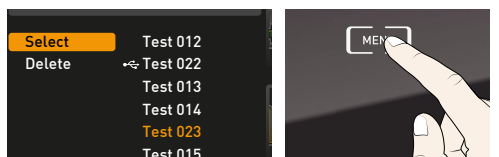

You can now remove the USB storage medium.

To delete a programme, select **Delete** with the turn control and select the programme to be deleted the same way you can select a programme for activation.

7.7 Sounds

In the **SOUND** display, you can define whether or not the appliance should emit acoustic signals and, if yes, define on which events it should do so:

- ▶ on the press of a key
- ▶ at the end of a programme
- ▶ On alarm
- ▶ if the door is open

1. Activate the acoustic signal adjustment. To do so, press the activation key on the left side of the **SOUND** display. The display is enlarged. The first category (in this case **Keysound**) is automatically highlighted. On the right, the current settings are shown on.

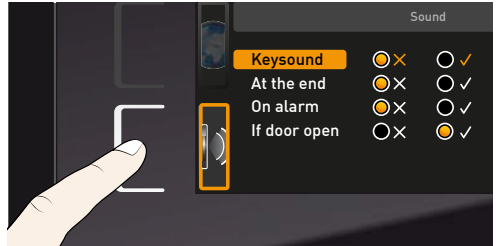

2. If you want to edit another list entry: Turn the turn control until the respective entry – e.g. **if door open** (special configuration) – is highlighted in colour.

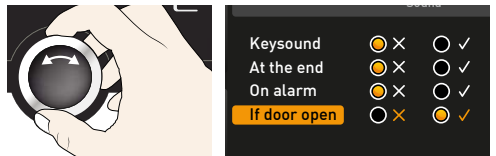

2. Save the selection by pressing the confirmation key. The adjustment options are automatically highlighted.

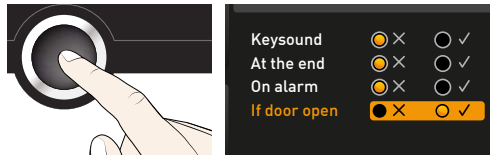

3. Select the desired setting with the turn control.

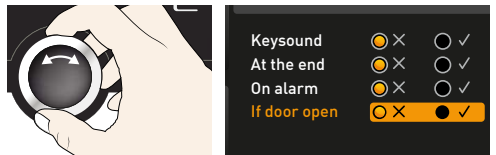

4. Save the setting by pressing the confirmation key.

1. If an acoustic alarm sounds, it can be turned off by pressing the confirmation key.

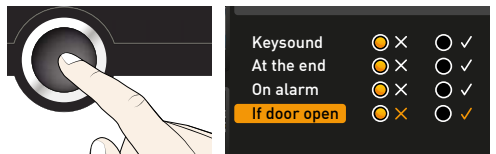

7.8 Protocol

The appliance continually logs all relevant measured values, settings and error messages at 1-minute intervals. The internal log memory is of the continuous memory type. The logging function cannot be switched off and is always active. The measured data are stored in the appliance, safe from manipulation. If the power supply is interrupted, the time of the power failure and voltage recovery are stored in the appliance.

You can export the protocol data for different periods to a USB storage medium via the USB port or, via Ethernet, import them to the AtmoCONTROL software for graphical representation, print-out or storage.

i The log memory of the appliance is not modified or deleted by reading it out.

1. Connect the USB storage medium to the USB port on the right of the ControlCOCKPIT.

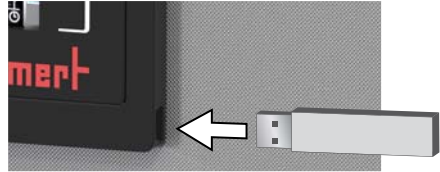

2. Activate the protocol. To do so, press the activation key on the right side of the PROTOCOL display. The display is enlarged and the period **This month** automatically highlighted.

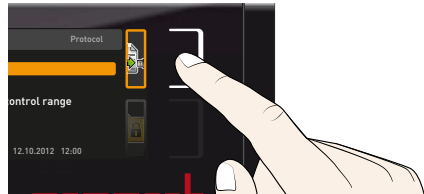

3. Save your selection by pressing the confirmation key. The transfer starts and a status symbol indicates the progress.

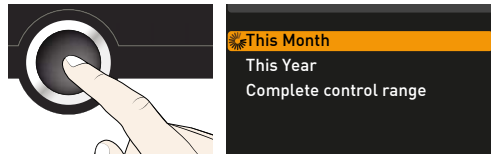

4. As soon as the transfer is complete, a check mark appears in front of the period selected. You can now remove the USB storage medium.

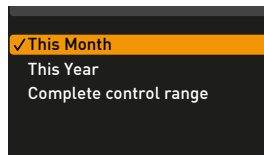

For a description of how to import and process protocol data in AtmoCONTROL or read it out via Ethernet, please refer to the separate AtmoCONTROL manual.

7.9 USER ID

7.9.1 Description

With the USER ID function, you can lock the settings of individual (e.g. temperature) or all parameters, so that they cannot be changed at the appliance by accident or unauthorised persons. You can also lock setting options in menu mode (e.g. adjustment or date and time settings) this way.

1 If adjustment options are locked, this is indicated by the lock symbol in the respective display (Fig. 30).

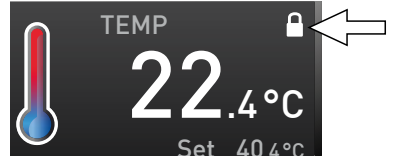

Fig. 30 Temperature adjustment at appliance locked (example)

USER ID data is entered in the AtmoCONTROL software and saved on the USB storage medium. The USB storage medium is thus acting as a key: Parameters can only be locked or unlocked if it is connected.

1 A description of how to create a USER ID in AtmoCONTROL is provided in the separate AtmoCONTROL manual.

7.9.2 USER ID activation and deactivation

1. Connect the USB storage medium with the USER ID data to the USB port on the right of the ControlCOCKPIT.

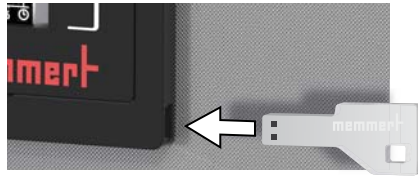

2. Activate the USER ID. To do so, press the activation key on the right side of the USER ID display. The display is enlarged and the entry **Activate** automatically highlighted.

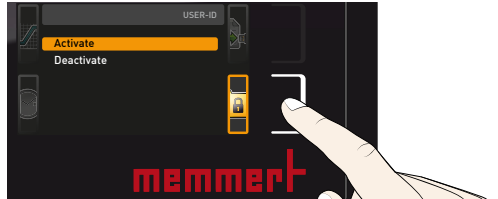

3. Confirm the activation by pressing the confirmation key. The new USER ID data are transferred from the USB storage medium and activated. As soon as activation is complete, a check mark appears in front of the corresponding entry.

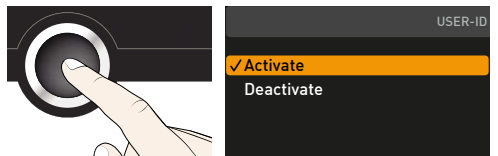

4. Remove the USB storage medium. Locked parameters are indicated by the lock symbol on the respective display (Fig. 30).

To unlock the appliance, connect the USB storage medium, activate the USER ID display and select the entry **Deactivate**.

8. Maintenance and Servicing

**⚠ WARNING**

Risk of electric shock. Disconnect the mains plug before any cleaning or maintenance work.

**⚠ WARNING**

With appliances above a specific size, you could become accidentally locked inside the appliance which could put you at risk of death. Do not climb into the appliance!

**⚠ CAUTION**

Danger of cuts due to sharp edges. Always wear gloves when working inside the chamber.

8.1 Cleaning

8.1.1 Interior and metal surfaces

Regular cleaning of the easy-to-clean interior prevents build up of material remains that could impair the appearance and functionality of the stainless steel chamber over time. The metal surfaces of the appliance can be cleaned with normal stainless steel cleaning agents. Make sure that no rusty objects come into contact with the interior or with the stainless steel housing. Rust deposits can lead to an infection of the stainless steel. If rust spots should appear on the surface of the interior due to impurities, the affected area must be immediately cleaned and polished.

8.1.2 Plastic parts

Do not clean the ControlCOCKPIT and other plastic parts of the appliance with caustic or solvent-based cleaning agents.

8.1.3 Glass surfaces

Glass surfaces can be cleaned with a commercially available glass cleaner.

8.2 Regular maintenance

Once a year, grease the moving parts of the doors (hinges and lock) with thin silicone grease and check that the hinge screws are not loose.

To guarantee perfect control, we recommend calibrating the appliance once a year (see page 49).

8.3 Repairs and Service

**⚠ WARNING**

Live parts may be exposed once the covers have been removed. Touching these can lead to an electrical shock. Disconnect the mains plug before removing any covers. Any work inside the appliance may only be performed by qualified electricians.



Repairs and service work are described in a separate service manual.

9. Storage and disposal

9.1 Storage

The appliance may only be stored under the following conditions:

- ▶ in a dry and enclosed, dust-free room
- ▶ frost-free
- ▶ disconnected from the power supply

9.2 Disposal

This product is subject to Directive 2002/96/EC on Waste Electrical and Electronic Equipment (WEEE) of the European Parliament and of the Council of Ministers. This appliance was placed on the market after August 13th, 2005 in countries which have already integrated this Directive into their national laws. It may not be disposed of in normal household waste. For disposal, please contact your dealer or the manufacturer. Any appliances that are infected, infectious or contaminated with materials hazardous to health are excluded from return. Please also observe all other regulations applicable in this context.

Before disposing of the appliance, please render the door locking mechanism unusable, for example to prevent playing children from being locked inside the appliance.

There is a lithium battery in the ControlCOCKPIT of the appliance. Remove it and dispose of it in accordance with the regulations in your country (Fig. 31).

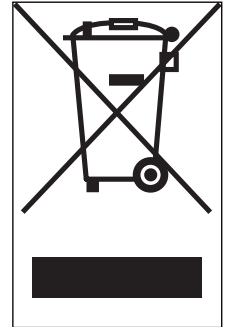

Fig. 31 Removing the lithium battery

Index

- A**
Accessories 16
Activation button 27
Adjusting doors 20
Adjustment 49
Air flap position 28
Alarm 33, 34, 38
Ambient conditions 15
Ambient temperature 16
Appliance error 39
ASF 32, 34
AtmoCONTROL 3, 12, 16, 27, 30, 51, 54, 55
Automatic temperature monitor 33
- B**
Balance 46
Basic device settings 42
Basic settings 42
- C**
CALIB 50
Calibration 49
Cause of errors 39
CEE 21
Chamber load 25
Changes 6
Cleaning 56
Communication interfaces 12
Compensation correction values 51
Connections 12
ControlCOCKPIT 10, 26
Customer service 2
- D**
Date 48
Declaration of conformity 15
Delete programme 52
Delivery 17, 21
Digital backwards counter with target time setting 29
Dimensions 15
Directives 15
Disposal 58
- Door 23
Door lock 24, 30, 31, 32, 37, 51
- E**
Electrical connection 12
Electronic temperature monitoring 33
Emergency 7
Ending operation 37
End of programme 31
Error description 39
Error message 40
Error messages 38
Ethernet 12
Explosion protection 6
- F**
Fan speed 28
Forklift truck 17
Function 11
- G**
Graph 36
- H**
Hazards 5
Heat output distribution 47
- I**
Installation site 18
Intended use 6
Interfaces 12
IP address 44
- K**
Keysound 53
- L**
Language selection 43
Loading the appliance 25
Log memory 41, 54
- M**
Maintenance 56
Malfunctions 7, 38
Manufacturer 2
Material 11
Mechanical temperature monitoring 35
- Menu 42
Monitoring temperature 32
- N**
Network 12, 44
Normal mode 27, 28
- O**
Operating 23
Operating modes 27
Operating personnel 6, 23
Operating problems 39
Operation 23
- P**
Packaging material 17
Parameter adjustment 27, 43
Power failure 41
Power supply 54
Product safety 5
Prog 52
Programme 51
Programme mode 27, 30
Protocol 54
PT100 temperature sensor 32
Putting into operation 21
- R**
Rectifying errors 39
Regular maintenance 56
- S**
Safety regulations 4, 10
Service 57
Servicing 57
Setting up 17, 18
Setup 44
Slide-in unit 46
Sound 53
SOUND 53
Speaker symbol 33, 38
Standards 15
Storage after delivery 18
Switching off 37
Switching on 22

Index

T

Taking out of service 58
TB 35
Technical data 14
Temperature 28
Temperature comparison 49
Temperature deviation 50
Temperature limiter 35
Temperature monitor 32, 34
Temperature monitoring 32,
45
Temperature sensor 32
Time 48
Timer 29
Timer mode 46
Transfer key 24, 31, 32
Transport 17
Transport damage 17
Turn control 27
TWB 33
TWW 33
TWW temperature monitor-
ing 33, 34
Type plate 13

U

Unit 45
Unpacking 17
USB port 12, 54
USER ID 55

W

Warning messages 12, 38
Weight 14



memmert
Experts in Thermostatics

Pass-through oven UFTS

D39059 | Date 03/2017

Englisch

Memmert GmbH + Co. KG
Willi-Memmert-Straße 90-96 | D-91186 Büchenbach
Tel. +49 9122 925-0 | Fax +49 9122 14585
E-Mail: sales@memmert.com
facebook.com/memmert.family
Die Experten-Plattform: www.atmosafe.net