



memmert
Experts in Thermostatics

ICP



OPERATING INSTRUCTIONS

COMPRESSOR-COOLED INCUBATOR ICP

100% ATMOSAFE. MADE IN GERMANY.

www.memmert.com | www.atmosafe.net

Manufacturer and customer service

Memmert GmbH + Co. KG
Willi Memmert Straße 90-96
D-91186 Büchenbach
Deutschland

Phone: +49 (0)9122 925-0
Fax: +49 (0)9122 14585
E-mail: sales@memmert.com
Internet: www.memmert.com

Customer service:

Service hotline: +49 (0)9171 9792 911
Service fax: +49 (0)9171 9792 979
E-mail: service@memmert.com

When contacting customer service, always quote the product serial number on the nameplate (see page 11).

Shipping address for repairs:

Memmert GmbH + Co. KG
Kundenservice
Willi-Memmert-Str. 90-96
DE-91186 Büchenbach
Germany

Please contact our customer service before sending appliances for repair or before returning equipment, otherwise, we have to refuse acceptance of the shipment.

© 2017 MEMMERT GmbH + Co. KG

D30374 | Date 03/2017

We reserve the right to make changes

About this manual

Purpose and target audience

This manual describes the assembly, function, transport and operation of compressor-cooled incubators ICP. It is intended for use by trained personnel of the owner, who have the task of operating and/or maintaining the respective appliance.

If you are asked to work on the appliance, read this manual carefully before starting. Familiarise yourself with the safety regulations. Only perform work that is described in this manual. If there is something you do not understand, or certain information is missing, ask your manager or contact the manufacturer. Do not do anything without authorisation.

Versions

The appliances are available in different configurations and sizes. If specific equipment features or functions are available only for certain configurations, this is indicated at the relevant points in this manual.

The functions described in this manual refer to the latest firmware version.

Due to individual configurations and sizes, illustrations in this manual may be slightly different from the actual appearance. Function and operation are identical.

Other documents that have to be observed:

- ▶ For operation of the appliance with MEMMERT AtmoCONTROL, observe the separate software manual. To open the AtmoCONTROL software manual, click on "Help" in the AtmoCONTROL menu bar.
- ▶ For service and repair work (see page 49), observe the separate service manual

Storage and resale

This instruction manual belongs with the appliance and should always be stored where persons working on the appliance have access to it. It is the responsibility of the owner to ensure that persons who are working or will work on the appliance are informed as to the whereabouts of this instruction manual. We recommend that it is always stored in a protected location close to the appliance. Make sure that the instruction manual is not damaged by heat or humidity. If the appliance is resold or transported and then set up again at a different location, the operating instructions must go with it.

You can also download the current version of this instruction manual as a PDF file under www.memmert.com/de/service/downloads/bedienungsanleitung/.

Contents

1. For your Safety	6
1.1 Terms and signs used	6
1.1.1 Terms used	6
1.1.2 Signs used	6
1.2 Product safety and dangers	7
1.3 Requirements of the operating personnel	7
1.4 Responsibility of the owner	7
1.5 Intended use	8
1.6 Changes and conversions	8
1.7 Behaviour in case of malfunctions and irregularities	8
1.8 Switching off the appliance in an emergency	8
2. Construction and description	9
2.1 Construction	9
2.2 Description	10
2.3 Material	10
2.4 Electrical equipment	10
2.5 Connections and interfaces	10
2.5.1 Electrical connection	10
2.5.2 Communication interfaces	10
2.6 Designation (nameplate)	11
2.7 Technical data	12
2.8 Applied guidelines and standards	13
2.9 Declaration of conformity	13
2.10 Ambient conditions	13
2.11 Scope of delivery	13
2.12 Optional accessories	14
3. Delivery, transport and setting up	15
3.1 For your Safety	15
3.2 Delivery	16
3.3 Transport	16
3.4 Unpacking	16
3.4.1 Checking for completeness and transport damage	16
3.4.2 Removing the transport protection	16
3.4.3 Disposing of packaging material	16
3.5 Storage after delivery	16
3.6 Setting up	17
3.6.1 Prerequisites	17
3.6.2 Tilt protection	18
3.6.3 Adjusting the doors (only for model sizes 450 and 750)	19
4. Putting into operation	20
4.1 Connecting the appliance	20
4.2 Switching on	20
5. Operation and Control	21
5.1 Operating personnel	21
5.2 Opening the door	21
5.3 Loading the appliance	22
5.4 Operating the appliance	23

5.4.1	ControlCOCKPIT	23
5.4.2	Basic operation.....	23
5.4.3	Operating modes	24
5.4.4	Manual mode.....	25
5.4.5	Operation with digital backwards counter with target time setting, adjustable from 1 minute to 99 days (Timer)	25
5.4.6	Programme mode	26
5.5	Monitoring function.....	28
5.5.1	Temperature monitoring	28
5.5.2	Mechanical temperature monitoring: Temperature limiter (TB).....	30
5.6	Graph.....	32
5.7	Ending operation.....	32
6.	Malfunctions, warning and error messages	33
6.1	Warning messages of the monitoring function.....	33
6.1.1	Temperature monitoring	33
6.2	Malfunctions, operating problems and appliance errors	34
6.3	Power failure.....	35
7.	Menu mode	36
7.1	Overview.....	36
7.2	Basic operation in menu mode using the example of language selection.....	37
7.3	Setup.....	38
7.3.1	Overview.....	38
7.3.2	IP address	38
7.3.3	Unit.....	39
7.3.4	Timer mode	40
7.3.5	Type of the slide-in unit (Grid or Shelf).....	40
7.3.6	Automatic defrosting system (Defrost).....	40
7.3.7	Remote control	41
7.3.8	Gateway	41
7.4	Date and Time	41
7.5	Calibrate.....	43
7.6	Programmes	45
7.7	Sound	46
7.8	Protocol	47
7.9	User ID	48
7.9.1	Description	48
7.9.2	User ID activation and deactivation	48
8.	Maintenance and Servicing	49
8.1	Cleaning.....	49
8.1.1	Interior and metal surfaces	49
8.1.2	Plastic parts	49
8.1.3	Glass surfaces.....	49
8.1.4	Cooling unit.....	50
8.2	Repairs and Service.....	50
9.	Storage and disposal	51
9.1	Storage	51
9.2	Disposal	51
	Index	52

1. For your Safety

1.1 Terms and signs used

In this manual and at the appliance, certain common terms and signs are used to warn you of danger or to give you hints that are important in avoiding injury or damage. Observe and follow these hints and regulations to avoid accidents and damage. These terms and signs are explained below.

1.1.1 Terms used

"Warning" is used whenever you or somebody else could be injured if you do not observe the accompanying safety regulation.

"Caution" is used for information that is important for avoiding damage.

1.1.2 Signs used

Warning signs (warning of a danger)				
Danger of electrocution	Danger of explosion	Dangerous gases / vapours	Danger of toppling over	Hazard area! Observe the operating instructions
Prohibition signs (forbidding an action)				
Do not lift	Do not tilt	Do not enter		
Regulation signs (stipulating an action)				
Disconnect the mains plug	Wear gloves	Wear safety boots	Observe information in separate manual	
Other icons				
	Important or useful additional information			

1.2 Product safety and dangers

The appliances described in this manual are technically sophisticated, manufactured using high-quality materials and subject to many hours of testing in the factory. They contain the latest technology and comply with recognised technical safety regulations. However, there are still risks involved, even when the appliances are used as intended. These are described below.



Warning!

After removing covers, live parts may be exposed. You may receive an electric shock if you touch these parts. Disconnect the mains plug before removing any covers. Only electrical technicians may work on the electrical equipment of the appliances.



Warning!

When loading the appliance with an unsuitable load, poisonous or explosive vapours or gases may be produced. This could cause the appliance to explode, and persons could be severely injured or poisoned. The appliance may only be loaded with materials/test objects which do not form any toxic or explosive vapours when heated up (see also chapter Intended use on page 8).



Warning!

If the door is open while the appliance is in operation, the appliance may overheat and pose a fire hazard. Do not leave the door open during operation.



Warning!

You can get accidentally locked in if the appliance has a certain size, which is life-threatening. Do not climb into the appliance!

1.3 Requirements of the operating personnel

The appliance may only be operated and maintained by persons who are of legal age and have been instructed accordingly. Personnel who are to be trained, instructed or who are undergoing general training may only work with the appliance under the continuous supervision of an experienced person.

Repairs may only be performed by qualified electricians. The regulations in the separate service manual must be observed.

1.4 Responsibility of the owner

The owner of the appliance

- ▶ is responsible for the flawless condition of the appliance and for it being operated in accordance with its intended use (see page 8);
- ▶ is responsible for ensuring that persons who are to operate or service the appliance are qualified to do this, have been instructed accordingly and are familiar with the operating instructions at hand;
- ▶ must know about the applicable guidelines, requirements and operational safety regulations, and train staff accordingly;

- ▶ is responsible for ensuring that unauthorised persons have no access to the appliance;
- ▶ is responsible for ensuring that the maintenance plan is adhered to and that maintenance work is carried out properly (see page 49);
- ▶ has to ensure that the appliance and its surroundings are kept clean and tidy, for example through corresponding instructions and inspections;
- ▶ is responsible for ensuring that personal protective clothing is worn by operating personnel, e.g. work clothes, safety shoes and protective gloves.

1.5 Intended use

Compressor-cooled incubators ICP may be used exclusively for temperature testing of materials and substances in the context of the procedures and specifications described in this manual. Any other use is improper, and may result in hazards and damage.

The appliance is not explosion-proof (does not comply with the German workplace health & safety regulation VBG 24). The appliance may only be loaded with materials and substances which cannot form any toxic or explosive vapours at the set temperature and which cannot explode, burst or ignite.

The appliance may not be used for drying, vaporising and branding paints or similar materials the solvents of which could form an explosive mixture when combined with air. If there is any doubt as to the composition of materials, they must not be loaded into the appliance. Potentially explosive gas-air mixtures must not form, neither in the working chamber nor in the direct vicinity of the appliance.

1.6 Changes and conversions

No unauthorised changes or alterations may be made to the appliance. No parts may be added or inserted which have not been approved by the manufacturer.

Unauthorised changes or alterations result in the CE declaration of conformity losing its validity, and the appliance may no longer be operated.

The manufacturer is not liable for any damage, danger or injuries that result from unauthorised changes or alterations, or from non-observance of the regulations in this manual.

1.7 Behaviour in case of malfunctions and irregularities

The appliance may only be used in a flawless condition. If you as the operator notice irregularities, malfunctions or damage, immediately take the appliance out of service and inform your superior.

i You can find information on eliminating malfunctions from page 33.

1.8 Switching off the appliance in an emergency

Press the main switch at the ControlCOCKPIT (Fig. 1) and disconnect the power plug. This disconnects the appliance from the power supply at all poles.

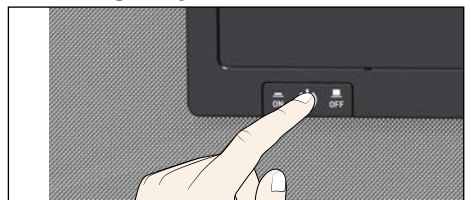

Fig. 1
Switch off the appliance by pressing the main switch

2. Construction and description

2.1 Construction

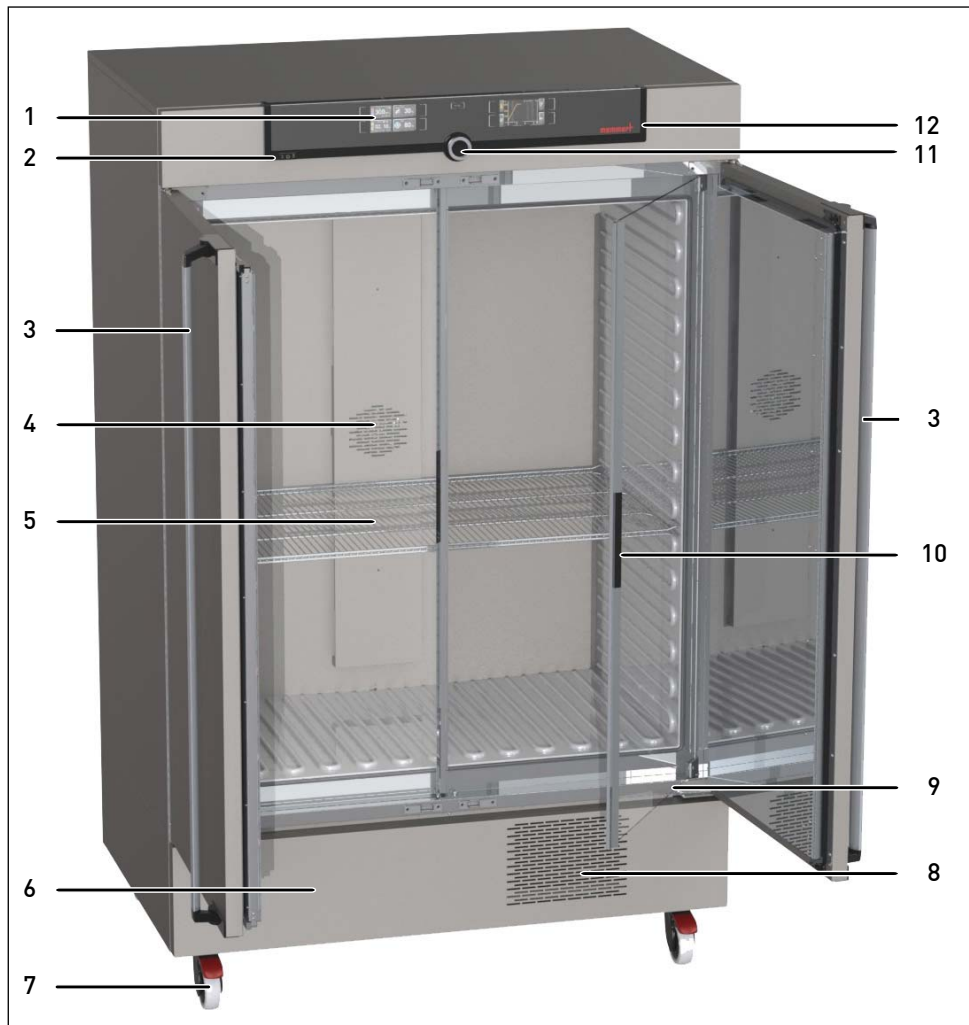

Fig. 2 Construction

- | | |
|---|---------------------------------------|
| 1 ControlCOCKPIT with capacitive function keys and LCD displays (see page 23) | 7 Castors |
| 2 On/Off switch (see page 20) | 8 Cooling unit fan |
| 3 Door handle (see page 21) | 9 Nameplate (see page 11) |
| 4 Chamber fan | 10 Inner glass door |
| 5 Steel grid | 11 Turn control with confirmation key |
| 6 Cooling unit (see page 50) | 12 USB interface (see page 10) |

2.2 Description

The appliance can heat the interior up to 60 °C and cool it down to -12 °C or 0 °C (depending on appliance size). For cooling, a compressor is used.

2.3 Material

For the outer housing, MEMMERT deploys stainless steel (Mat.No. 1.4016 – ASTM 430) and for the interior, stainless steel (Mat.No. 1.4301 – ASTM 304) is used, which stands out through its high stability, optimal hygienic properties and corrosion resistance to many (but not all!) chemical compounds (caution for example with chlorine compounds).

The chamber load for the appliance must be carefully checked for chemical compatibility with the materials mentioned. A material resistance table can be requested from the manufacturer.

2.4 Electrical equipment

- ▶ Operating voltage and current consumption: See nameplate
- ▶ Protection class I, i.e. operation insulation with PE conductor in accordance with EN 61010
- ▶ Protection type IP 20 acc. to EN 60 529
- ▶ Interference suppression acc. to EN 55011 class B
- ▶ Appliance fuse: Safety fuse 250 V/15 A, quick-blow
- ▶ The temperature controller is protected with a miniature fuse 100 mA (160 mA at 115 V)

2.5 Connections and interfaces

2.5.1 Electrical connection

This appliance is intended for operation on an electrical power system with a system impedance Z_{max} of a maximum of 0.292 ohm at the point of transfer (service line). The operator must ensure that the appliance is operated only on an electrical power system that meets these requirements. If necessary, you can ask your local energy supply company what the system impedance is.

Observe the country-specific regulations when connecting (e.g. in Germany DIN VDE 0100 with residual current circuit breaker).

2.5.2 Communication interfaces

The communication interfaces are intended for appliances fulfilling the requirements of the IEC 60950-1 standard.

USB interface

The appliance is fitted by default with a USB interface in accordance with the USB specification. This way, you can

- ▶ transfer software stored on a USB storage medium to the appliance (see page 45).
- ▶ export protocol logs from the appliance to a USB storage medium (see page 47).
- ▶ transfer USER ID data stored on a USB storage medium to the appliance (see page 46).

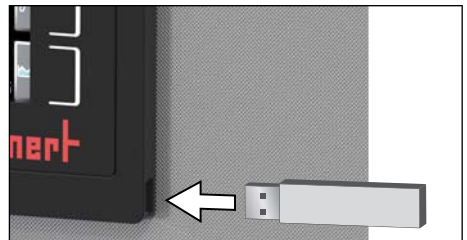

Fig. 3 USB interface

The USB port can be found on the right side of the ControlCOCKPIT (Fig. 3).

Ethernet interface

Via Ethernet interface, the appliance can be connected to a network, so that you can transfer programmes created with AtmoCONTROL software to the appliance and read out protocols. The Ethernet interface is located on the rear of the appliance (Fig. 4).

For identification purposes, each appliance connected must have its own unique IP address. Setting the IP address is described on page 38.

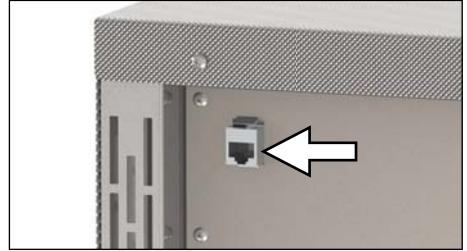

Fig. 4 Ethernet interface



You will find a description of how to transfer programmes via Ethernet in the enclosed AtmoCONTROL manual.

With an optional USB to Ethernet converter, the appliance can be directly connected to a computer / laptop (see Optional accessories on page 14).

2.6 Designation (nameplate)

The nameplate (Fig. 5) provides information about the appliance model, manufacturer and technical data. It is attached to the front of the appliance, on the right behind the door (see page 9).

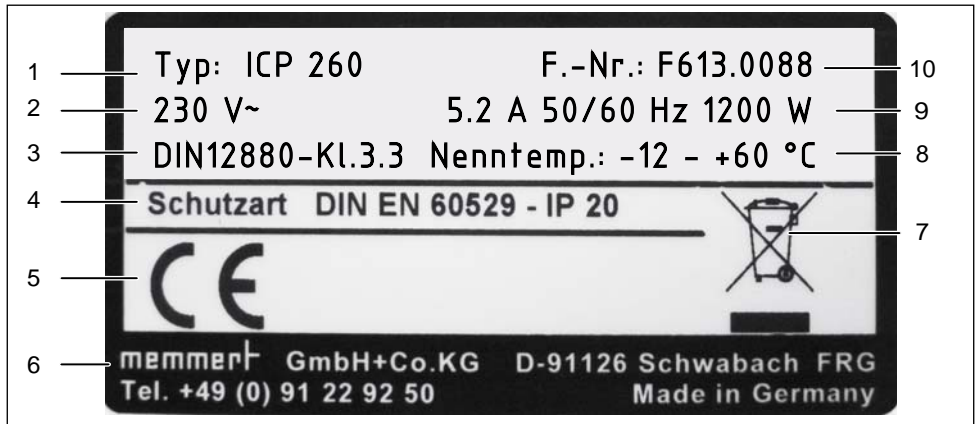

Fig. 5 Nameplate (example)

- | | | | |
|---|---------------------|----|----------------------------|
| 1 | Type designation | 6 | Address of manufacturer |
| 2 | Operating voltage | 7 | Disposal note |
| 3 | Applicable standard | 8 | Temperature range |
| 4 | Protection type | 9 | Connection / power ratings |
| 5 | CE conformity | 10 | Appliance number |

2.7 Technical data

Appliance size		55	110	260	450	750
Appliance width D ¹ [mm]		585	745	824	1224	1224
Appliance height E ¹ [mm]		1153	1233	1552	1613	1950
Appliance depth F ¹ (without door handle) [mm]		514	584	684	784	784
Depth of door lock [mm]		56				
Chamber width A ¹ [mm]		400	560	640	1040	1040
Chamber height B ¹ [mm]		400	480	800	720	1200
Chamber depth C ¹ [mm]		330	400	500	600	600
Chamber volume [litres]		53	108	256	449	749
Weight incl. packaging [kg]		104	127	209	287	324
Power [W]		1200				
Current consumption [A]	230 V, 50/60 Hz	5.2				
	115 V, 50/60 Hz	10.4				
max. number of sliding shelves		4	5	9	8	14
max. load per sliding shelf [kg]		20			30	
max. load per appliance [kg]		80	150	200		
Temperature	Adjustment range	-5 to 60 °C ²		-12 to 60 °C ²		
	Adjustment precision	0.1 K				

¹ see Fig. 6.

² With the interior lighting on, the minimum temperature might not be reached.

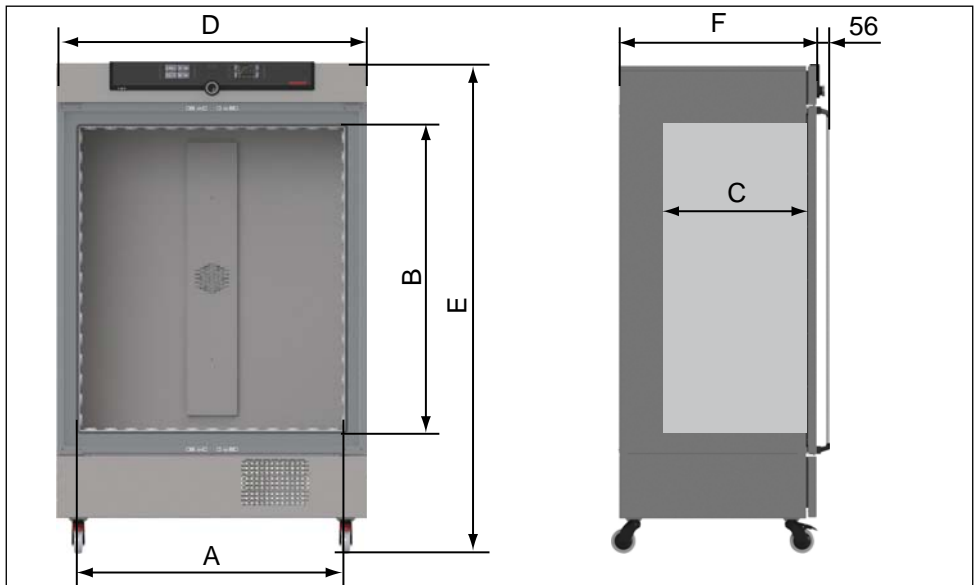

Fig. 6 Dimensions

2.8 Applied guidelines and standards

- ▶ Directive 2004/108/EC with amendments (directive of the council on the approximation of the laws of the member states relating to electromagnetic compatibility). Standards complied with:
DIN EN 61326:2004-05, EN 61326:1997, EN 61326/A1:1998, EN 61326/A2:2001
EN 61326/A2:2003
- ▶ Directive 2006/42/EC (directive of the European Parliament and of the Council of 17 May 2006 on machinery, and amending Directive 95/16/EG (revision). Standards complied with:
DIN EN ISO 12100-1:2003, DIN EN ISO 12100-2:2003
EN ISO 14121-1:2007, EN ISO 14121-2:2007

2.9 Declaration of conformity

You can download the EC declaration of conformity of the appliance online:

English: <http://www.memmert.com/en/service/downloads/ce-statement/>

German: <http://www.memmert.com/de/service/downloads/eg-konformitaetserklaerung/>

2.10 Ambient conditions

- ▶ The appliance may only be used in enclosed areas and at the following ambient conditions:

Ambient temperature	15 °C to 28 °C (up to 34 °C with limited temperature range)
Humidity rh	max. 70 %, non-condensing
Overvoltage category	II
Pollution degree	2
Altitude of installation	max. 2,000 m above sea level

- ▶ The appliance may not be used in areas where there is a risk of explosion. The ambient air must not contain any explosive dusts, gases, vapours or gas-air mixtures. The appliance is not explosion-proof.
- ▶ Heavy dust production or aggressive vapours in the vicinity of the appliance could lead to sedimentation in the interior and, as a consequence, could result in short circuits or damage to electrical parts. For this reason, sufficient measures to prevent large clouds of dust or aggressive vapours from developing should be taken.

2.11 Scope of delivery

- ▶ Power cable
- ▶ Sliding grid (load capacity 30 kg each)
- ▶ USB storage medium with software and AtmoCONTROL manual
- ▶ the operating instructions at hand
- ▶ Calibration certificate
- ▶ Separately packaged fastening material for wall mounting (see page 17)

2.12 Optional accessories

- ▶ USB to Ethernet converter (Fig. 7). Makes it possible to connect the appliance's network interface (see page 11) to the USB port of a computer / laptop.
- ▶ Reinforced, sliding steel grids with a load capacity of 60 kg each (for appliance size 110 and larger)

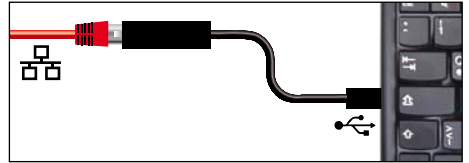

Fig. 7 Converter USB to Ethernet

3. Delivery, transport and setting up

3.1 For your Safety



Warning!

Because of the heavy weight of the appliance, you could injure yourself if you try to lift it. To carry appliances of the sizes 55 and 110, at least four persons are required. Appliances larger than that may not be carried but must be transported with a manual pallet jack or forklift truck.

55	110	260	450	750



Warning!

You may get your hands or feet squashed when transporting and installing the appliance. Wear protective gloves and safety boots. When grasping the bottom of the appliance, grasp it only on the sides:

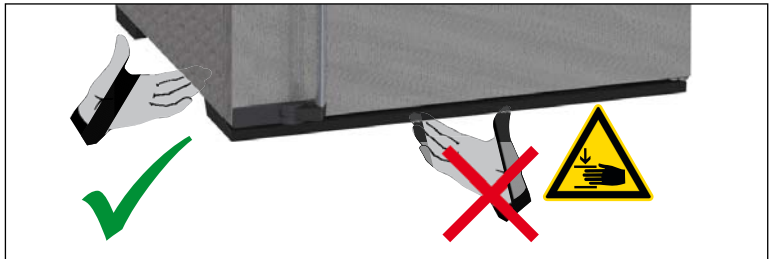

Warning!

The appliance could fall over and seriously injure you. Never tilt the appliance and transport it in upright position and without load only (except for standard accessories such as steel grids or shelves). Appliances with castors always have to be moved by two people.

3.2 Delivery

The appliance is packed in cardboard and is delivered on a wooden palette.

3.3 Transport

The appliance can be transported in three ways:

- ▶ With a forklift truck; move the forks of the truck entirely under the pallet.
- ▶ On a manual pallet jack
- ▶ On its own castors, in case of the corresponding configuration, for which the catch on the (front) castors must be released

3.4 Unpacking

i To avoid damage, do not unpack the appliance until you reach the installation site.

Remove the cardboard packaging by pulling it upwards or carefully cutting along an edge.

3.4.1 Checking for completeness and transport damage

- ▶ Check the delivery note to ensure that the delivery is complete.
- ▶ Check the appliance for damage.

If you notice deviations from the delivery note, damage or irregularities, do not put the appliance into operation but inform the haulage company and the manufacturer.

3.4.2 Removing the transport protection

Remove the transport protection. It is located between the door hinge, door and frame and has to be removed after opening the door.

3.4.3 Disposing of packaging material

Dispose of the packaging material (cardboard, wood, foil) in accordance with the applicable disposal regulations for the respective material in your country.

3.5 Storage after delivery

If the appliance is first to be stored after delivery: Read the storage conditions from page 51.

3.6 Setting up



Warning!

Due to its centre of gravity, the appliance can fall over to the front and injure you or other people. Always attach the appliance to a wall with the tilt protection (see page 18). If this is not possible due to spatial constrictions, do not put the appliance into operation and do not open the door. Please contact Memmert customer service (see page 2).

The appliance must only be set up on the floor.

3.6.1 Prerequisites

The installation site must be flat and horizontal and must be able to reliably bear the weight of the appliance (see Technical data on page 12). Do not place the appliance on a flammable surface.

Depending on the model (see nameplate), a 230 V or 115 V power connection must be available at the installation site.

The distance between the wall and the rear of the appliance must be at least 15 cm. The clearance from the ceiling must not be less than 20 cm and the side clearance from walls or nearby appliances must not be less than 5 cm (Fig. 8). Sufficient air circulation in the vicinity of the appliance must be guaranteed at all times. Do not place any objects in front of the fan opening of the cooling unit at the front of the appliance.

For appliances with castors, always direct them to the front.

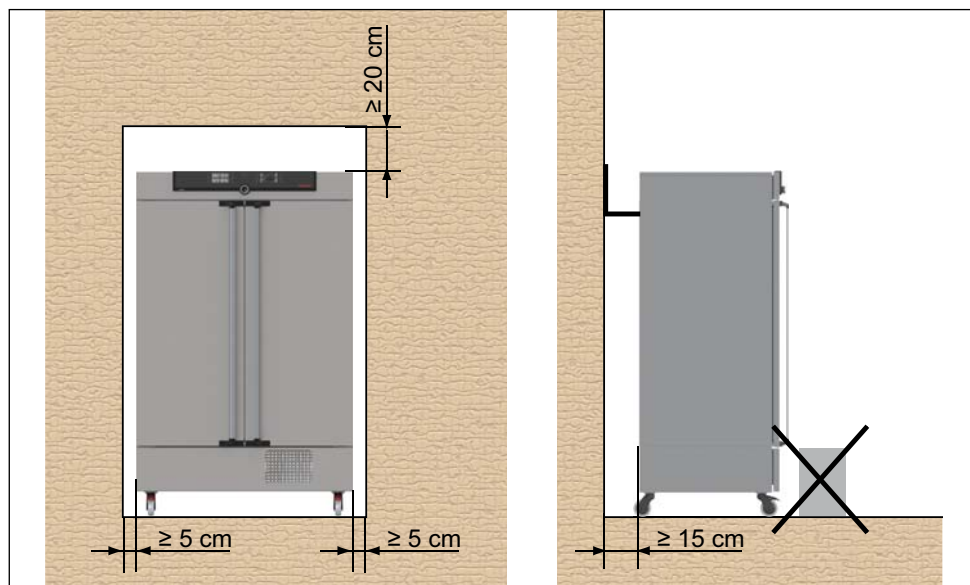
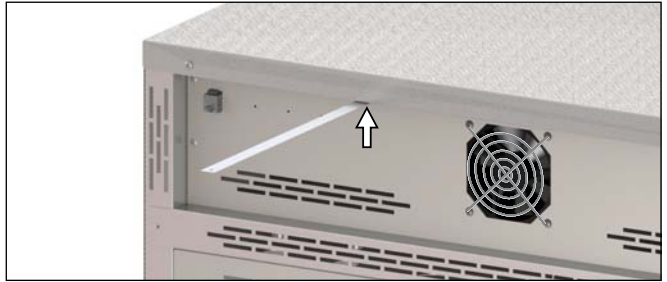

Fig. 8 Minimum clearance from walls and ceiling

3.6.2 Tilt protection

Attach the appliance to a wall with the tilt protection. The tilt protection is included in the delivery.

1. Screw the tilt protection to the rear of the appliance as illustrated.



2. Bend the tilt protection upwards by 90° in the desired distance to the wall (consider the minimum distance to the wall, see page Fig. 8).



3. Drill a hole, insert a plug and screw the tilt protection to a suitable wall.

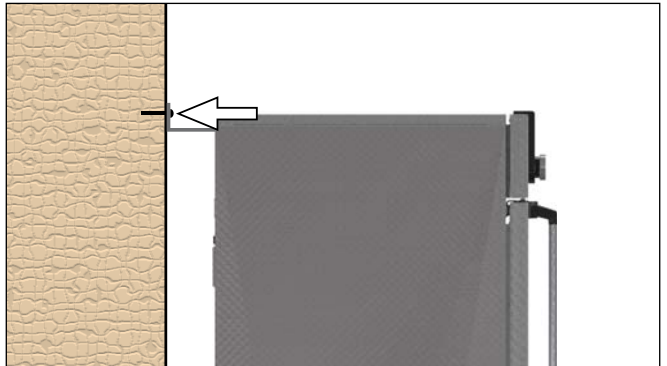

3.6.3 Adjusting the doors (only for model sizes 450 and 750)

For model sizes 450 and 750, it is possible to adjust doors that warp due to the floor conditions. In order to do so, every door has two adjuster screws at the top and at the bottom (Fig. 9).

1 First, adjust the door at the top and then, if further adjustment is necessary, at the bottom as well.

1. Open the door.
2. Undo the screws.
3. Adjust the door.
4. Tighten the screws again.
5. Check door alignment.
6. If necessary, readjust.

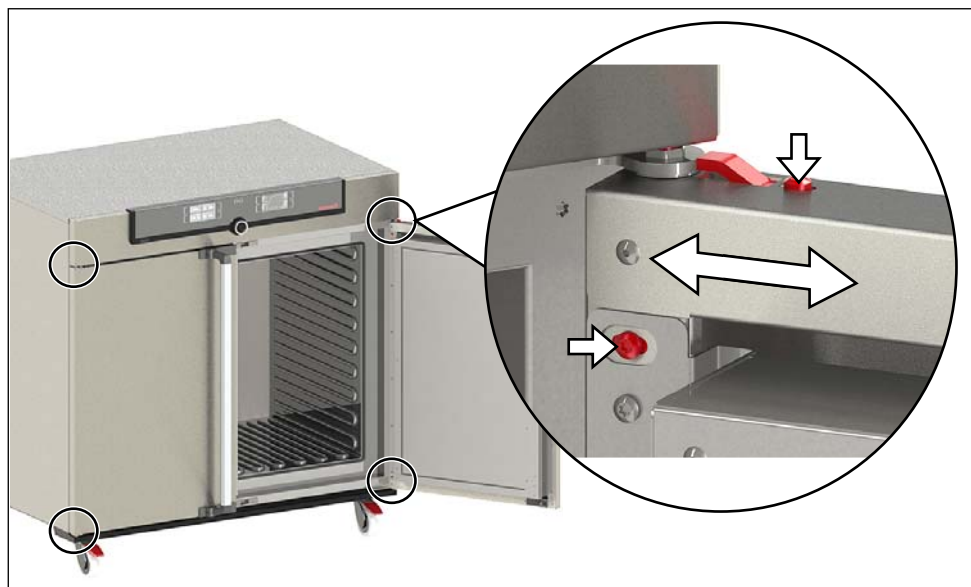

Fig. 9 Door adjustment screws

4. Putting into operation

● Caution:

1 The first time the appliance is operated, it must not be left unattended until it has reached the steady state.

The temperature limiter might have been triggered during transport. Press the red button on the back of the appliance to reset the temperature limiter before putting the appliance into operation.

4.1 Connecting the appliance

● Caution:

1 Observe the country-specific regulations when making connections (e.g. in Germany DIN VDE 0100 with residual current circuit breaker). Observe the connection and power ratings (see nameplate and "Technical Data" on page 12). Make sure to establish a safe PE conductor connection.

Plug the provided power cable into the rear of the appliance and connect it to the power supply (Fig. 10).

Lay the power cable so that

- ▶ it is always accessible and within reach so it can be disconnected quickly in the event of failure or emergencies;
- ▶ no one can trip over it;
- ▶ it does not come into contact with any hot parts.

4.2 Switching on

Switch on the appliance by pressing the main switch on the front of the appliance (Fig. 11).

The starting process is shown by three animated white dots **●●●**. If the dots have another colour, an error has occurred (see page 35).

1 After the first start-up, the appliance display is set to English by default. You can change the language as described from page 37. However, to get a basic overview of operating the appliance, you should read the following chapter first.

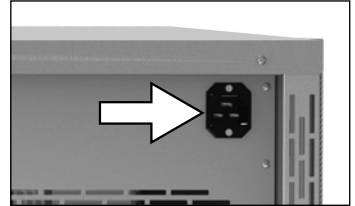

Fig. 10 Connect the power cable to the rear of the appliance

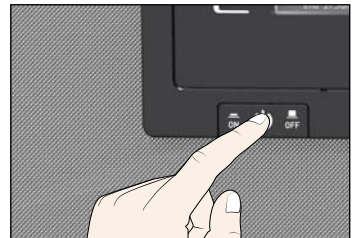

Fig. 11 Switch on appliance

5. Operation and Control

**Caution!**

When in operation, small amounts of condensed water may leak from the appliance. Always wear shoes with slip-proof soles and wipe up the condensed water immediately.

**Caution!**

The surfaces in the appliance's interior and the chamber load may be very cold. Always wear gloves when you touch the interior of the appliance.

5.1 Operating personnel

The appliance may only be operated by persons who are of legal age and have been instructed accordingly. Personnel who are to be trained, instructed or who are undergoing general training may only work with the appliance under the continuous supervision of an experienced person.

5.2 Opening the door

- ▶ To open the door, pull the door handle to the side (to the left or to the right, depending on the door variation, see Fig. 12, A) and open the door completely.
- ▶ To close the appliance, push the door closed and the door handle to the side (B).

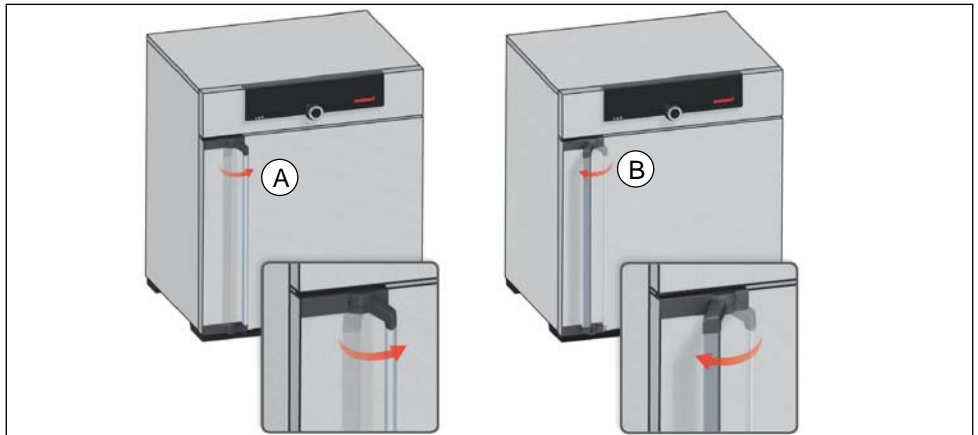

Fig. 12 Opening and closing the door

**Warning!**

If the door is open while the appliance is in operation, the appliance may overheat and pose a fire hazard. Do not leave the door open during operation.

**Warning!**

In case of appliances of a certain size, you can get accidentally locked in, which is life-threatening. Do not climb into the appliance!

5.3 Loading the appliance



Warning!

When loading the appliance with an unsuitable load, poisonous or explosive vapours or gases may be produced. This could cause the appliance to explode, and persons could be severely injured or poisoned. The appliance may only be loaded with materials which do not form any toxic or explosive vapours when heated up and cannot ignite (see also Intended use on page 8). If there is any doubt as to the composition of materials, they must not be loaded into the appliance.



i Caution:

Check the chamber load for chemical compatibility with the materials of the appliance (see page 10).

Insert the sliding steel grids or sliding shelves. The maximum number of grids / shelves and the load capacity are specified in the technical data overview from page 12.

To achieve a suitable heat output, the type of drawer used – grid or shelf – has to be set in the menu under **SETUP** (see page 40).

The chamber must not be loaded too tightly, so that proper air circulation in the interior is guaranteed. Do not place any of the chamber load on the floor, touching the side walls or right below the ceiling of the chamber (Fig. 13, see also the "correct loading" sticker on the appliance).

In case of improper loading (chamber loaded too tightly), the set temperature may be exceeded or it may take longer until it is reached.

The appliance is not suitable for long-term storing at sub-zero temperatures. During permanent operation, the glass door may ice over.

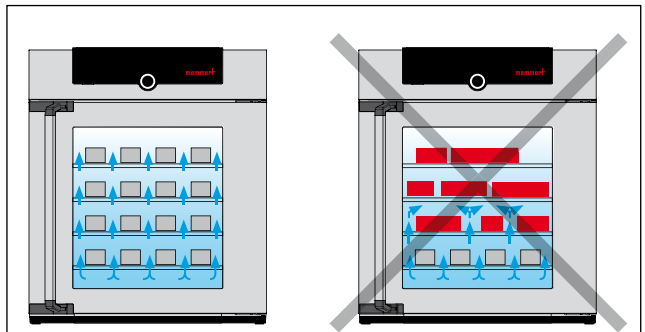

Fig. 13 Correct placement of the chamber load

5.4 Operating the appliance

5.4.1 ControlCOCKPIT

In manual operation, the desired parameters are entered at the ControlCOCKPIT at the front of the appliance (Fig. 14). You can also make basic settings here (menu mode). Additionally, warning messages are displayed, e.g. if the temperature is exceeded. In programme mode, the parameters defined, the programme description, the programme segment currently active and programme duration remaining are displayed (for a more detailed description, see page 26).

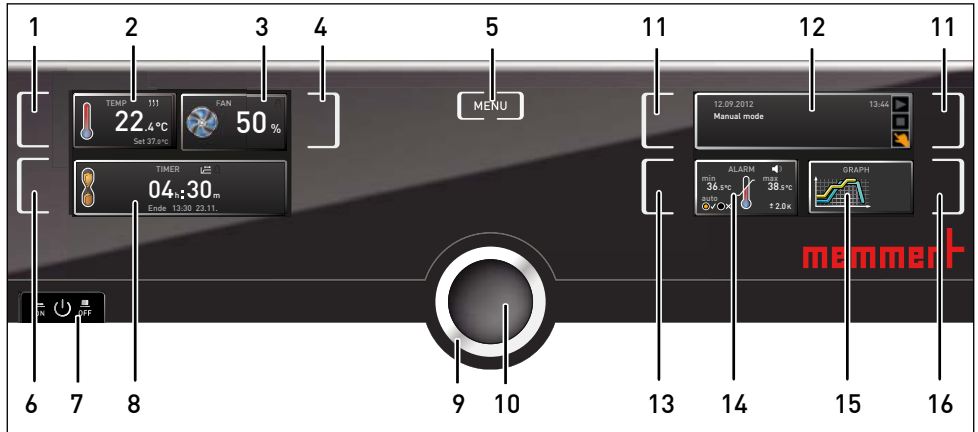

Fig. 14 ControlCOCKPIT in operating mode (width may differ depending on appliance size)

- | | |
|---|---|
| <ul style="list-style-type: none"> 1 Activation key for temperature setpoint adjustment 2 Setpoint and actual temperature display 3 Fan display 4 Activation key for fan speed setting 5 Switch to menu mode (see page 36) 6 Activation key digital backwards counter with target time setting, adjustable from 1 minute to 99 days 7 On/Off switch 8 Display digital backwards counter with target time setting, adjustable from 1 minute to 99 days | <ul style="list-style-type: none"> 9 Turn control for setpoint adjustment 10 Confirmation key (accepts setting made with the turn control) 11 Activation key for the appliance state 12 Appliance state and programme display 13 Activation key for temperature monitoring 14 Monitoring display 15 Graphic representation 16 Activation key for graphic representation |
|---|---|

5.4.2 Basic operation

In general, all settings are made according to the following pattern:

1. Activate the desired parameter (e.g. temperature). To do so, press the corresponding activation key on the left or right of the respective display. The activated display is lined in colour, the other displays are dimmed. The set value is highlighted in colour.

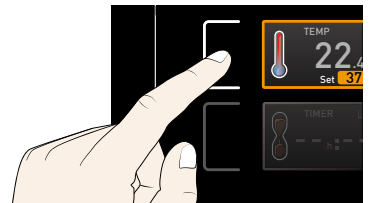

- By turning the turn control to the left or right, adjust the set value (e.g. to 37.0 °C).

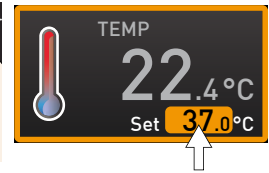

- Save the set value by pressing the confirmation key. The display returns to normal and the appliance begins adjusting to the defined set value.

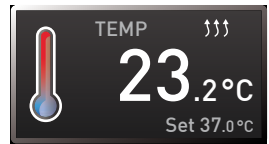
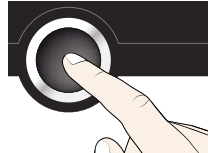

Additional parameters can be set accordingly.

- If no new values are entered or confirmed for approx. 30 seconds, the appliance automatically restores the former values.

If you want to cancel the setting procedure, press the activation key on the left or right of the display that you want to exit. The appliance restores the former values. Only the settings that you have confirmed by pressing the confirmation key before cancelling the setting procedure are accepted.

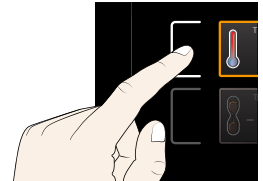

5.4.3 Operating modes

The appliance can be operated in different modes:

- ▶ **Manual mode:** The appliance runs in permanent operation at the values set on the ControlCOCKPIT. Operation in this mode is described in chapter 5.4.4.
- ▶ **Operation with digital backwards counter with target time setting, adjustable from 1 minute to 99 days (Timer):** The appliance runs at the values set until the timer has elapsed. Operation in this mode is described in chapter 5.4.5.
- ▶ **Programme mode:** The appliance automatically runs programme sequences which have been defined using AtmoCONTROL software at a computer / laptop and then transferred to the appliance from a USB stick or via Ethernet. Operation in this mode is described in chapter 5.4.6.
- ▶ via remote control

- The status display shows you which operating mode or operating state the appliance is currently in. The current operating state is highlighted in colour and indicated by the text display:

- ▶ Appliance is in programme mode
- Appliance is stopped
- 👉 Appliance is in manual operating mode

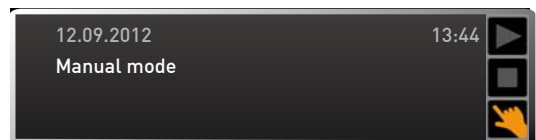

The example on the right shows the appliance in manual mode, identified by the coloured hand symbol.

- ▶ When the appliance is in timer mode, **Timer active** is displayed:

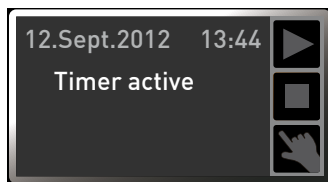

- ▶ When the appliance is in remote control mode, the  symbol appears in the temperature display:

5.4.4 Manual mode

In this operating mode, the appliance runs in permanent operation at the values set on the ControlCOCKPIT.

Adjustment options

As described in chapter 5.4.2, you can set the following parameters after pressing the corresponding activation key (in any sequence):

Temperature

Adjustment range: See nameplate and technical data on page 12)

- Heating operation is indicated by the  symbol.

- 1 Cooling is indicated by the  symbol.

You can select °C or °F as the temperature unit displayed (see page 39).

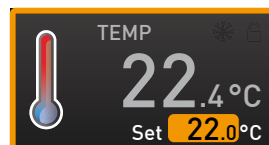
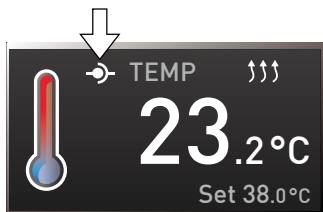

Fan speed

Adjustment range: 10 to 100 % in steps of 10%

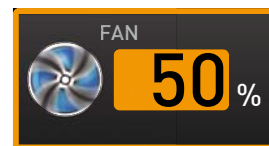

5.4.5 Operation with digital backwards counter with target time setting, adjustable from 1 minute to 99 days (Timer)

In timer operation, you can adjust the time the appliance runs at the set value. The appliance has to be in manual operating mode for this.

1. Press the activation key to the left of the timer display. The timer display is activated.

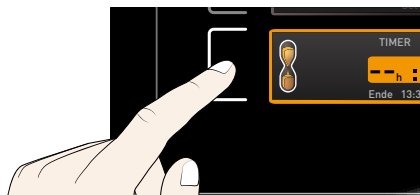

2. Turn the turn control until the desired duration is displayed – in this example 4 hours 30 minutes. The approximate end time is shown beneath, in a smaller font.



- 1 Up to a duration of 23 hours 59 minutes, the time is displayed in hh:mm (hours:minutes) format. For 24 hours and more, the format dd:hh (days:hours) is used. The maximum duration adjustable is 99 days 00 hours.
- 3. Press the confirmation key to confirm.

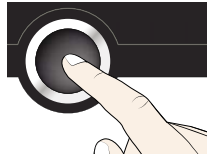

The display now shows the remaining time in a large font and the approximate end time in a smaller font beneath. The status display shows "Timer active".

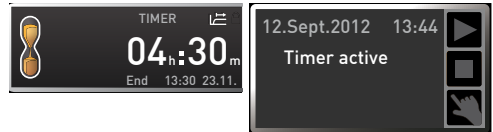

- 4. Now, as described under 5.4.2, set the individual values which you want the appliance to operate at. The set values can be changed at any time while the timer elapses. The changes are effective immediately.
- 1 In **Setup**, you can choose if the timer should run setpoint-dependent or not. This determines whether the timer should not start until a tolerance band around the set temperature is reached or if it should start right after activation (see page 40). If the timer runs setpoint-dependent, this is indicated by the symbol in the timer display.

When the timer has elapsed, the display shows 00h:00m. All functions (heating etc.) are switched off. An acoustic alarm sounds, which can be deactivated by pressing the confirmation key.



To deactivate the timer, open the timer display by pressing the activation key again and then turning the turn control to reduce the timer setting until --:-- is displayed. Confirm with the confirmation key.

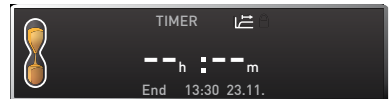

5.4.6 Programme mode

In this operating mode, programmes saved in the appliance can be started with different combinations of individual parameters (temperature, fan speed, interior lighting) at staggered intervals, which the appliance then automatically processes in sequence. These programmes are not created directly at the appliance but externally at a computer / laptop and using AtmoCONTROL software. Transfer to the appliance is possible using the provided USB storage medium or via Ethernet.



A description of how to create and save programmes can be found in the separate AtmoCONTROL software manual.

Starting a programme

1. Press the activation key to the right of the status display. The current operating mode is highlighted automatically, in this example **Manual mode** (👉).

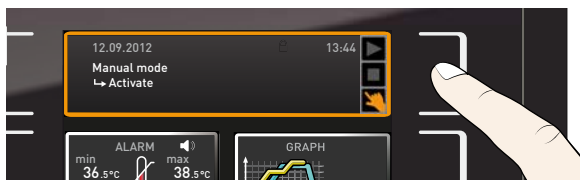

2. Turn the turn control until the start symbol is highlighted. The current programme is displayed, in this example **Test 012**.

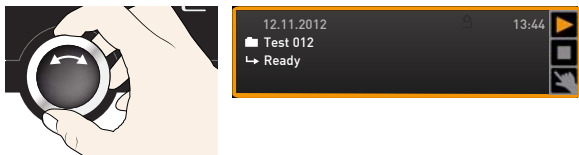

- 1 Only the programme currently selected in menu mode and shown in the display can be used. If you want to process another programme, you need to activate it in menu mode first (description from page 45).

3. To start the programme, press the confirmation key. The programme is ran. The display shows:

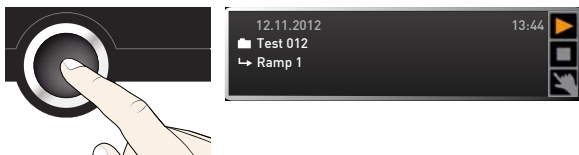

- ▶ the programme description (in this example **Test 012**)
- ▶ the programme segment description, in this example **Ramp 1**
- ▶ the current run (in case of loops)

- 1 You cannot change any parameters (e.g. the temperature) at the appliance while a programme is running. However, the displays **ALARM** and **GRAPH** can still be used.

Cancelling a programme

You can cancel an active programme at any time.

1. Press the activation key to the right of the status display. The status display is automatically highlighted.



2. Turn the turn control until the stop symbol is highlighted.

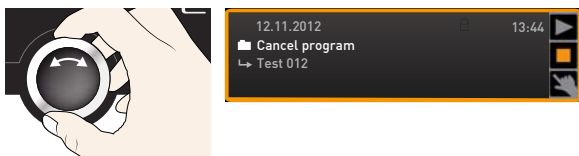

- Press the confirmation key to confirm. The programme is cancelled.

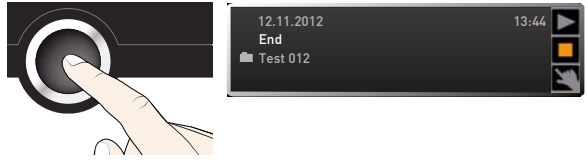

- A cancelled programme cannot be resumed at the point it was cancelled. It must be restarted from the beginning.

End of programme

The **End** display shows when the programme should end.

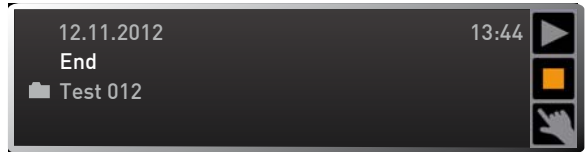

You can now

- ▶ restart the programme as described
- ▶ select another programme for processing in menu mode (see page 45) and run it as described.
- ▶ return to manual mode. To do so, reactivate it by pressing the activation key next to the status display, then turn the turn control until the hand symbol is highlighted in colour and press the confirmation key.

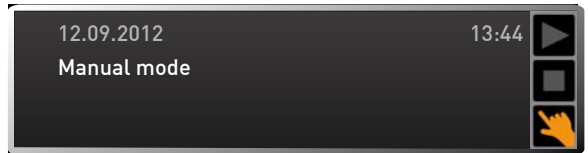

5.5 Monitoring function

5.5.1 Temperature monitoring

The appliance is equipped with a multiple overtemperature protection in accordance with DIN 12 880. This serves to avoid damage to the chamber load and/or appliance in case of a malfunction:

- ▶ electronic temperature monitoring (TWW)
- ▶ automatic temperature monitor (ASF)
- ▶ mechanical temperature limiter (TB)

The monitoring temperature of the electronic temperature monitoring is measured via a separate Pt100 temperature sensor in the interior. Temperature monitoring settings are made via the **ALARM** display. The settings made apply to all operating modes.

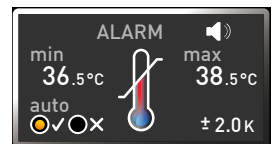

If temperature monitoring has been triggered, this is indicated by the temperature display: the actual temperature is highlighted in red and a  warning symbol is shown (Fig. 15). The type of temperature monitoring triggered (TWW in this example) is shown beneath the temperature. Information on what to do in this case is provided in the chapter Malfunctions, warning and error messages on page 33.

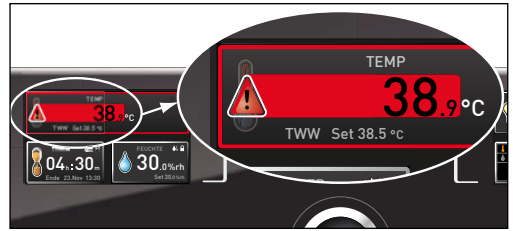



Fig. 15
Temperature monitoring triggered

If the acoustic signal for Alarm has been activated in menu mode (**Sound**, see page 46, which is indicated by the speaker symbol  in the alarm display), the alarm is additionally signalled by an intermittent acoustic signal, which can be deactivated by pressing the confirmation key.

Before reading how to adjust temperature monitoring (from page 30), please read the description of the individual monitoring functions here.

Electronic temperature monitoring (TWW)

The manually set monitoring temperature **min** and **max** of the overtemperature control is monitored by an adjustable over/undertemperature controller (TWW) protection class 3.3 acc. to DIN 12 880. If the manually set monitoring temperature **max** is exceeded, the TWW takes over temperature control and begins to regulate the monitoring temperature (Fig. 16).

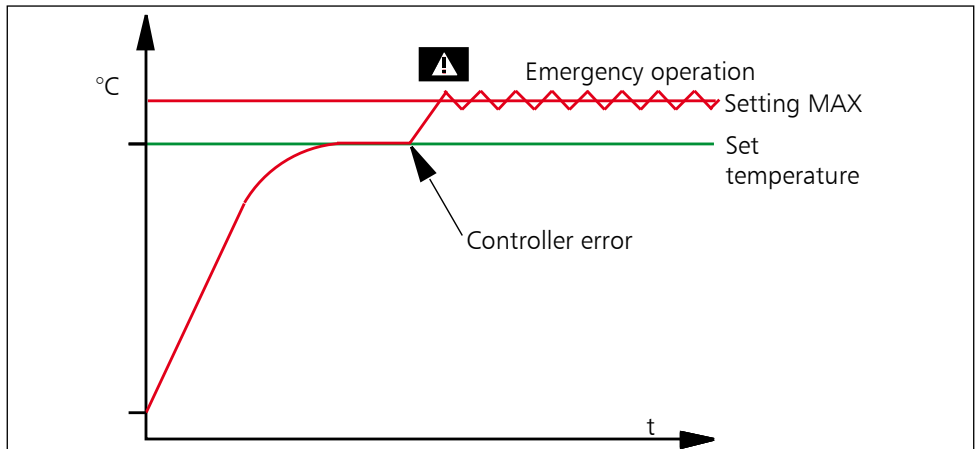

Fig. 16 Schematic diagram of how TWW temperature monitoring works

Automatic temperature monitor (ASF)

ASF is a monitoring device that automatically follows the set temperature setpoint within an adjustable tolerance band (Fig. 17).

The ASF – if switched on – is automatically activated as soon as the actual temperature value reaches 50 % of the set tolerance band of the setpoint (in the example: $50\text{ }^{\circ}\text{C} \pm 1\text{ K}$) for the first time (section A).

When the temperature violates the set tolerance band around the setpoint (in the example in Fig. 17:

$50\text{ }^{\circ}\text{C} \pm 2\text{ K}$) – e.g. if the door is opened during operation (section B of illustration) – the alarm is set off. The ASF alarm is automatically triggered as soon as 50 % of the set tolerance band of the setpoint (in the example: $50\text{ }^{\circ}\text{C} \pm 1\text{ K}$) are reached again (section C).

If the temperature setpoint is altered, the ASF is automatically disabled temporarily (in this example: The setpoint is changed from $50\text{ }^{\circ}\text{C}$ to $25\text{ }^{\circ}\text{C}$, section D), until it has reached the tolerance range of the new temperature setpoint (section E).

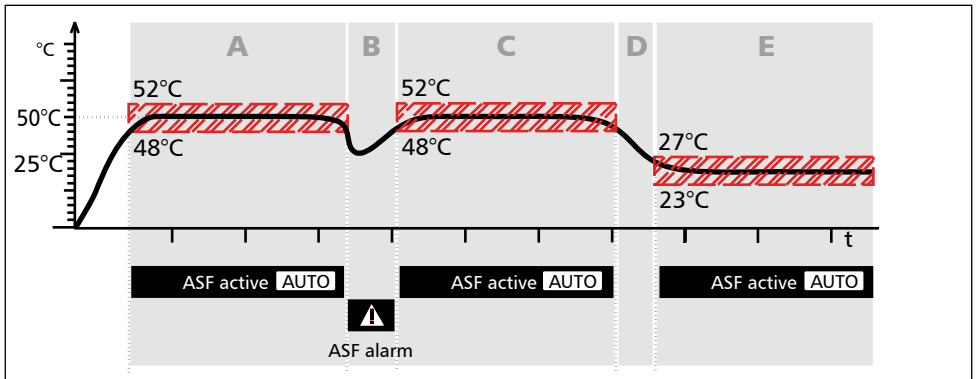

Fig. 17 Schematic diagram of how the ASF temperature monitoring works

5.5.2 Mechanical temperature monitoring: Temperature limiter (TB)

The appliance is equipped with a mechanical temperature limiter (TB) of protection class 1 in accordance with DIN 12 880 (Fig. 18).

If the electronic monitoring unit should fail during operation and the factory-set maximum temperature is exceeded by approx. $20\text{ }^{\circ}\text{C}$, the temperature limiter, as the final protective measure, switches off the heating permanently.



Fig. 18 Reset button for the mechanical temperature limiter (TB)

Adjusting temperature monitoring

Press the activation key to the left of the **ALARM** display. The min setting (under-temperature protection) is automatically activated.

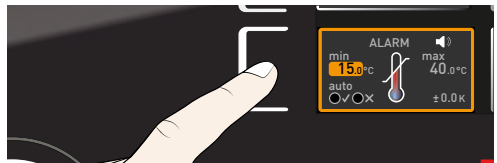

- By turning the turn control, adjust the desired lower alarm limit value, in the example on the right 35.5 °C.

i The lower alarm limit value cannot be set higher than the top one. If no undertemperature protection limit is required, set the lowest temperature.

- Press the confirmation key to confirm. The **max** display (overtemperature protection) is activated.

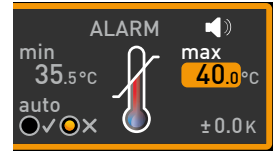
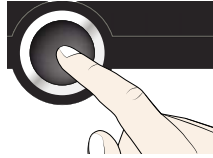
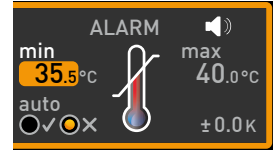

- By turning the turn control, adjust the desired upper alarm limit value, in the example on the right 38.5 °C.

i The monitoring temperature must be set sufficiently high above the maximum set temperature. We recommend 1 to 3 K.

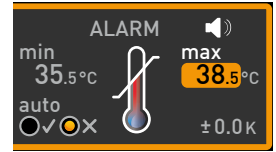
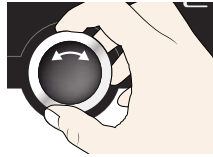

- Accept the upper alarm limit value by pressing the confirmation key. The setting of the automatic temperature monitor (ASF) is automatically activated (**auto**).

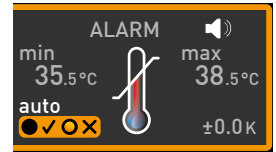
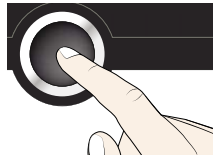

- With the turn control, select ON (✓) or OFF (✗).

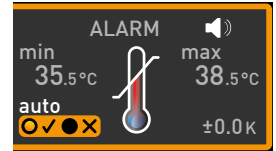

- Press the confirmation key to confirm. The ASF tolerance band setting is activated.

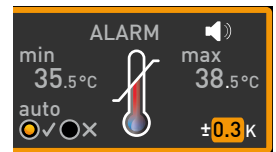
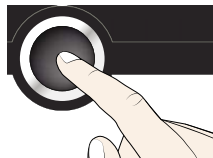

- With the turn control, adjust the desired tolerance band, e.g. 2.0 K.

i We recommend a tolerance band of 1 to 3 K.

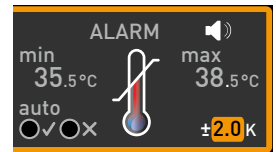

- Press the confirmation key to confirm. Temperature monitoring is now active.

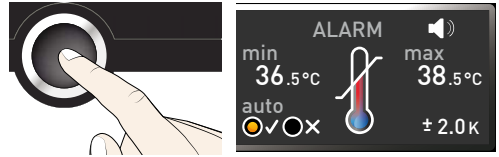

5.6 Graph

The GRAPH display provides an overview of the chronological sequence of the set values and the actual values as a curve.

Press the activation key to the right of the GRAPH display. The display is enlarged and the temperature profile shown.

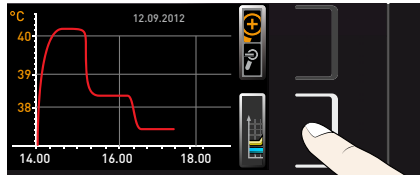

- ▶ To change the time frame to be displayed: Press the activation key next to the $\triangleleft \triangleright$ arrow symbols. The time frame can now be changed with the turn control.

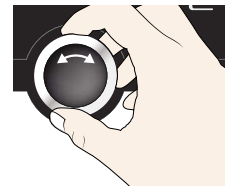
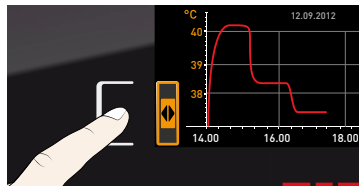

- ▶ To zoom the graph in or out: Press the activation key next to the magnifying glass symbol. Select whether you want to zoom in or out (+/-) with the turn control and confirm your selection by pressing the confirmation key.

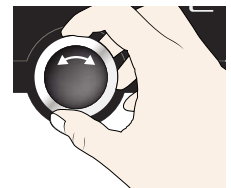

To close the graphical representation, again press the activation key which you have used to activate it.

5.7 Ending operation

- Switch off active appliance functions (turn back the set values).
- Remove the chamber load.
- Switch off the appliance with the main switch (Fig. 19).

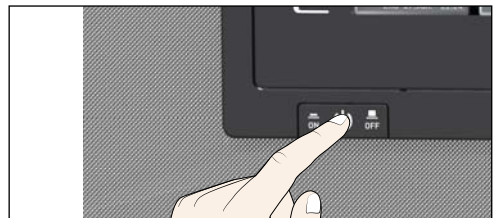

Fig. 19 Switch off appliance

6. Malfunctions, warning and error messages



Warning!

After removing covers, live parts may be exposed. You may receive an electric shock if you touch these parts. Malfunctions requiring work inside the appliance may only be rectified by electricians. Observe the separate service manual for this.

Do not try to rectify appliance errors yourself but contact the MEMMERT customer service department (see page 2) or an authorised service point.

In case of enquiries, please always specify the model and appliance number on the nameplate (see page 11).

6.1 Warning messages of the monitoring function

- i** If the acoustic signal for Alarm has been activated (Acoustic signals, see page 46, which is indicated by the speaker symbol ), the alarm is additionally signalled by an interval sound. If the confirmation key is pressed, the acoustic alarm can be temporarily switched off until the next alarm event occurs.

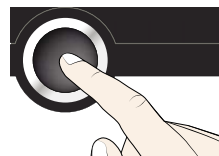

6.1.1 Temperature monitoring

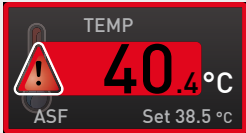
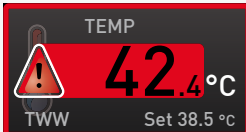

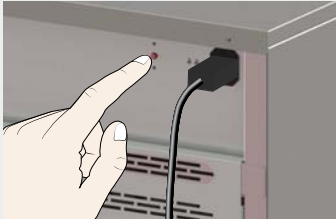

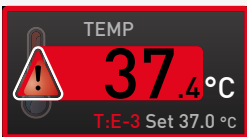

Description	Cause	Action	See
Temperature alarm and "ASF" are displayed 	Automatic temperature monitor (ASF) triggered	Check if the door is closed. Close the door. Extend the ASF tolerance band If the alarm continues: Contact customer service	page 47 page 2
Temperature alarm and "TWW" are displayed 	The adjustable undertemperature / overtemperature controller (TWW) has assumed heating control.	Increase the difference between the monitoring and setpoint temperature – by either increasing the max value of the temperature monitoring or decreasing the setpoint temperature. If the alarm continues: Contact customer service	page 46 page 2

Description	Cause	Action	See
Appliance does not heat up	The mechanical temperature limiter (TB) permanently switched off heating.	<ol style="list-style-type: none"> 1. Leave the appliance to cool down. 2. Reset the TB. To do so, press the red button at the rear side of the appliance until it locks into place with an audible click. 	page 2
		 <p>If the alarm continues: Contact customer service</p>	

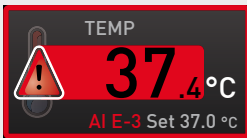
6.2 Malfunctions, operating problems and appliance errors

Error description	Cause of errors	Rectifying errors	See
Displays are dark	External power supply was interrupted	Check the power supply	page 20
	Miniature fuse, appliance fuse or power module faulty	Contact customer service	page 2
Displays cannot be activated	Appliance locked by USER ID	Unlock with USER ID	Page 46
	The appliance is in programme, timer or remote control mode (mode "Write" or "Write + Alarm")	Wait until the end of the programme or timer mode or switch off the remote control	
Displays suddenly look different	Appliance is in "wrong" mode	Change to operating or menu mode by pressing the MENU key	
Display T:E-3 in the temperature display	Temperature operating sensor defective. The monitoring sensor takes over the measurement function.	<ul style="list-style-type: none"> ▶ The appliance can be temporarily operated ▶ Contact customer service as soon as possible 	page 2



Error description	Cause of errors	Rectifying errors	See
<p>Error message AI E-3 in the temperature display</p> 	<p>Temperature monitoring sensor defective. The operating sensor takes over the measurement function.</p>	<ul style="list-style-type: none"> ▶ The appliance can temporarily be kept in service ▶ Contact customer service as soon as possible 	<p>page 2</p>
<p>Error message E-3 in the temperature display</p> 	<p>Operating and monitoring sensor defective</p>	<ul style="list-style-type: none"> ▶ Switch off appliance. ▶ Remove the chamber load ▶ Contact customer service 	<p>page 2</p>
<p>When switching on the appliance, the start animation is displayed in another colour than white </p>	<ul style="list-style-type: none"> ▶ Cyan : Not enough storage space on the SD card ▶ Red : The system files could not be loaded ▶ Orange : The fonts and images could not be loaded 	<p>Contact customer service</p> <p>Contact customer service</p> <p>Download the firmware update at memmert.com and install it</p>	<p>page 2</p> <p>page 2</p>

6.3 Power failure

In case of a power failure, the appliance operates as follows:

In manual mode

After power supply has been restored, operation is continued with the parameters set. The time and duration of the power failure are documented in the log memory.

In timer or programme mode

In case of an interruption of the power supply of less than 60 minutes, the current programme is continued from the point at which it was interrupted. For longer interruptions of the power supply, all appliance functions (heating, fan etc.) are switched off.

In remote control mode:

The previous values are restored. If a programme has been initiated via remote control, it is continued.

7. Menu mode

In menu mode, you can make basic settings as well as adjust appliance parameters.

Caution:

Before changing menu settings, read the description of the respective functions on the following pages to avoid possible damage to the appliance and/or chamber load.

To enter menu mode, press the MENU key.

To exit the menu mode at any time, press the MENU key again. The appliance then returns to operating mode. Only changes accepted by pressing the confirmation key are saved.

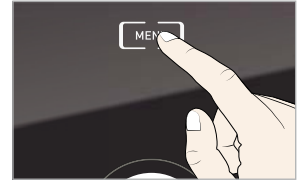

7.1 Overview

Press the MENU key to change between the displays in menu mode:

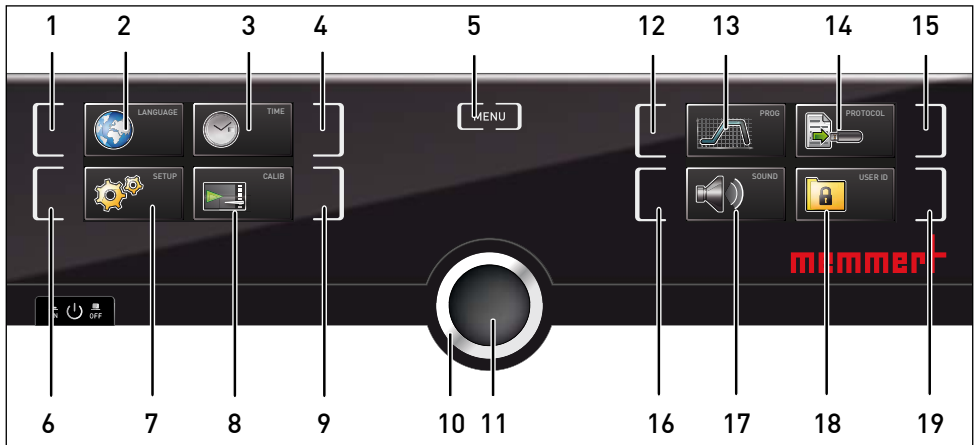

Fig. 20 ControlCOCKPIT in menu mode

- | | |
|---|--|
| 1 Language selection activation key | 11 Confirmation key (accepts setting made with the turn control) |
| 2 Language selection display | 12 Activation key programme selection |
| 3 Date and time display | 13 Display programme selection |
| 4 Date and time setting activation key | 14 Protocol display |
| 5 Exit menu mode and return to operating mode | 15 Protocol activation key |
| 6 Setup activation key (basic appliance settings) | 16 Acoustic signal adjustment activation key |
| 7 Setup display (basic appliance settings) | 17 Acoustic signal adjustment display |
| 8 Adjustment display | 18 USER ID display |
| 9 Adjustment activation key | 19 USER ID display activation key |
| 10 Turn control for adjustment | |

7.2 Basic operation in menu mode using the example of language selection

In general, all settings in menu mode are done just like in operating mode: Activate the respective display, use the turn control for setting and press the confirmation key to accept the change. A more detailed description is provided in the following, using the example of language selection.

1. Activate the desired parameter (in this example the language). To do so, press the corresponding activation key on the left or right of the respective display. The activated display is enlarged.

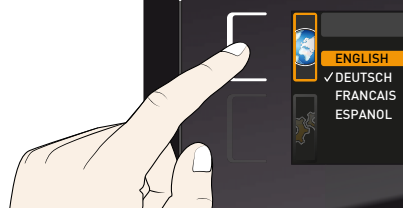

- i** If you want to interrupt or cancel your settings, again press the activation key which you have used to activate the display. The appliance returns to the menu overview. Only the settings that you have confirmed by pressing the confirmation key before cancelling the setting procedure are accepted.



2. With the turn control, select the desired new setting, e.g. Spanish (Español).

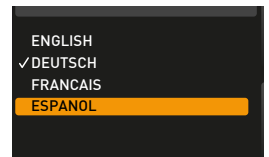

3. Save the setting by pressing the confirmation key.

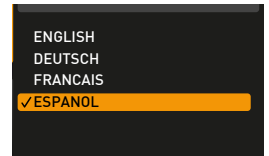
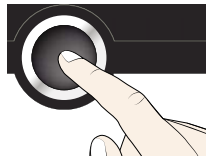

4. To return to the menu overview, press the activation key again.

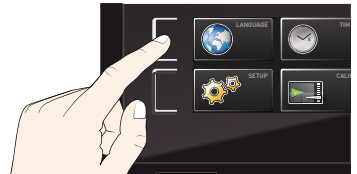

You can now

- ▶ activate another menu function by pressing the corresponding activation key or
- ▶ return to operating mode by pressing the MENU key.

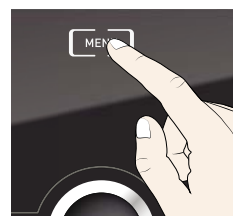
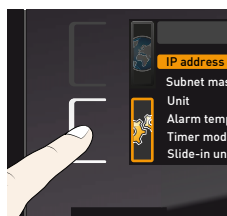

All other settings can be made accordingly. The settings possible are described in the following sections.

- If no new values are entered or confirmed for approx. 30 seconds, the appliance automatically restores the former values.

7.3 Setup

7.3.1 Overview

In the **SETUP** display, you can set the following parameters:

- ▶ the **IP address** and **Subnet mask** of the appliance's Ethernet interface (for connection to a network)
- ▶ the **Unit** of the temperature display (°C or °F, see page 39)
- ▶ how the digital backwards counter with target time setting works (**Timer mode**, see page 40)
- ▶ the type of drawer (grid or shelf, see page 40)
- ▶ the automatic defrosting system (**Defrost**, see page 40)
- ▶ Remote control (see page 41)
- ▶ Gateway (see page 41)

- If the setup menu contains more entries than can be displayed, this is indicated by the designation "1/2". This means that there is a second "page" of entries.

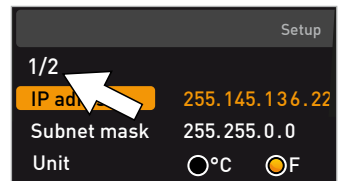

To access the entries not displayed, use the turn control to scroll beyond the lowest entry. The page display jumps to "2/2".

7.3.2 IP address

If you want to operate one or more appliances in a network, each appliance must have its own unique IP address for identification. By default, each appliance is delivered with the IP address 192.168.100.100.

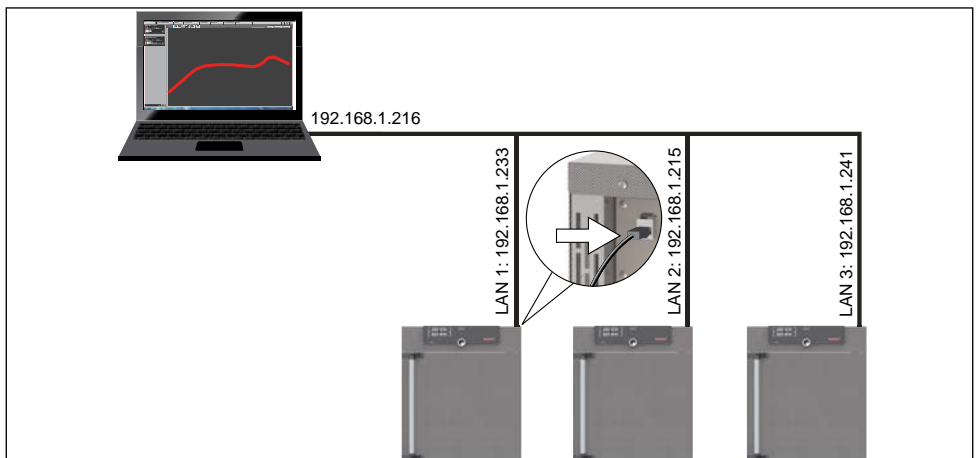
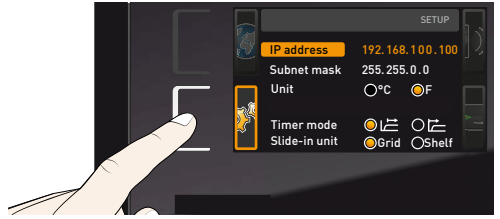
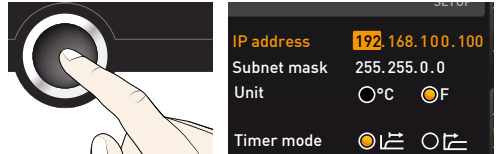

Fig. 21 Operation of several appliances in a network (schematic example)

1. Activate the **SETUP** display. The entry **IP address** is automatically highlighted.



2. Accept the selection by pressing the confirmation key. The first three digits of the IP address are automatically selected.



3. With the turn control, set the new number, e.g. 255.

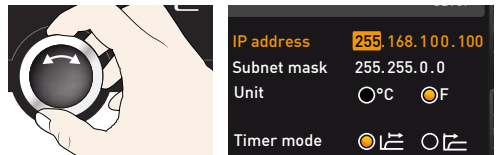

4. Accept the selection by pressing the confirmation key. The next three digits of the IP address are automatically selected. Setting these is done with the turn control according to the description above.

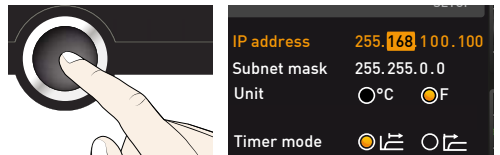

5. After setting the last three digits, accept the new IP address by pressing the confirmation key. The selection returns to the overview.

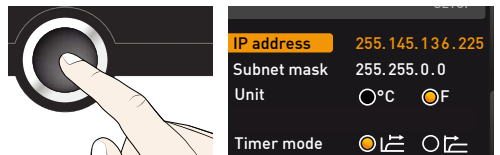

The subnet mask is set accordingly.

7.3.3 Unit

Here, you can choose whether the temperature is displayed in °C or °F.

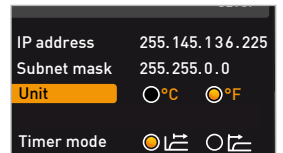

7.3.4 Timer mode

Here, you can choose whether the digital backwards counter with target time setting (see page 25) should run setpoint-dependent or not. This determines whether the timer should not start until a tolerance band of ± 3 K around the set temperature is reached (Fig. 22, B) or if it should start right after activation (A).

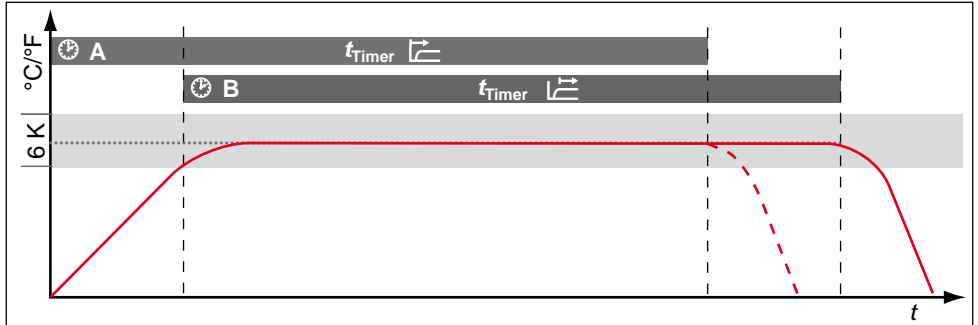
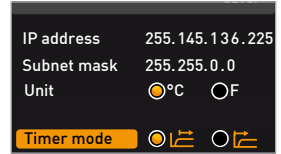

Fig. 22 Timer mode

A Timer independent of setpoint: Timer starts right after activation

B Timer setpoint-dependent: Timer does not start until tolerance band is reached

7.3.5 Type of the slide-in unit (Grid or Shelf)

Here, you have to set the type of the slide-in unit (grid or shelf) used. The selection Shelf enables you to adjust the control function to the different air flow characteristics in the interior when using optional sliding shelves instead of the grids that are part of the standard delivery.

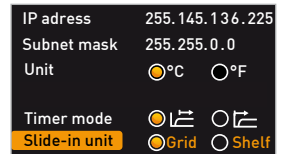

7.3.6 Automatic defrosting system (Defrost)

The integrated automatic defrosting system for the cooling unit ensures perfect operation of the cooled incubator at low temperatures and in permanent operation. The defrosting interval can be set in steps of 6 hours, between 6 and 48 hours. The setting Off deactivates automatic defrosting.

Due to long-term operation with a working temperature below $+15$ °C or due to a damp chamber load and/or the door opening frequently, ice can form in the interior over time. Heavy icing may impair the function of the appliance and could damage the cooling system. In this case, the working chamber should be defrosted. This can be achieved by short heating of the appliance (to 30-40 °C) or by switching it off for a longer period of time, e.g. over night. The resulting melting water can best be collected with a cloth at the front edge of the working chamber. Afterwards, the smooth surface of the interior can easily be cleaned.

Due to this automatic defrosting, there is a minor brief increase in the chamber temperature at regular intervals. If you would like to further reduce this impairment in performance, you can shorten the defrosting frequency, e.g. to every 24 hours.

In this case, please observe if there is a permanent drop in the cooling performance or a strong fluctuation of the actual value, which may be an indication that the cooling unit is icing over. If this is the case, please set the automatic defrosting system one level higher.

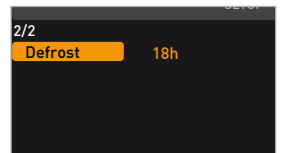

If humidity/room temperature are particularly high, it is possible that the factory setting for defrosting, 12 hours, is not sufficient. If this is the case, you should set a more frequent defrosting interval, e.g. every 6 hours.

Automatic defrosting is disabled with the setting **Off**. When operating at low temperatures, this over time causes the cooling unit to ice over. Regular defrosting needs to be carried out in order to prevent damage to the cooling system.

7.3.7 Remote control

In the setup entry **Remote control**, you can set whether the appliance should be controlled via remote control and if so, in which mode. These settings are available:

- ▶ **Off**
- ▶ **Read Only**
- ▶ **Write**
- ▶ **Write+Alarm**

When the appliance is in remote control mode, the  symbol appears in the temperature display. In the settings **Write** and **Write+Alarm**, the appliance cannot be controlled at the ControlCOCKPIT until the remote control has been switched off (setting **Off**) or set to **Read Only**.

 In order to use the remote control function, programming skills and special libraries are required.

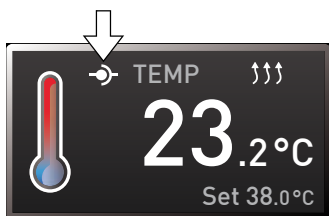
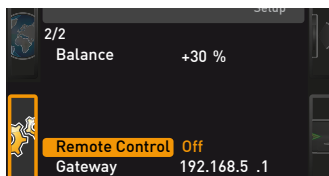

7.3.8 Gateway

The setup entry **Gateway** is used to connect two networks with different protocols.

The gateway is set the same way as the IP address (see page 38).

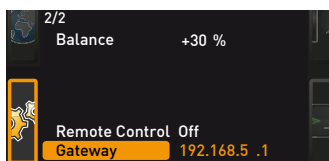

7.4 Date and Time

In the **Time** display, you can set date and time, time zone and daylight saving time.

- Always set the time zone (and summer time yes/no) before you set the date and time.
-  Avoid changing the set time after that since this can lead to gaps or overlapping when recording measured values. If you still need to change the time, you should not run a programme immediately before or after doing so.

1. Activate the time setting. To do so, press the activation key on the right side of the **Time** display. The display is enlarged and the first adjustment option (**Date**) automatically highlighted.

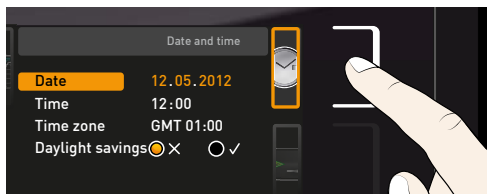

2. Turn the turn control until Time zone is highlighted.

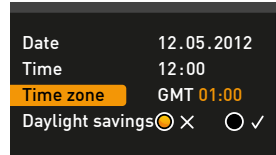
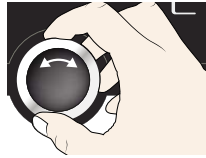

3. Accept the selection by pressing the confirmation key.

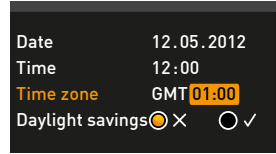
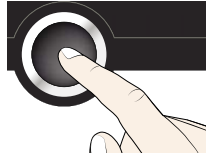

4. Set the time zone of the installation site with the turn control, e.g. 00:00 for France, Spain or Great Britain, 01:00 for Germany. Accept the selection by pressing the confirmation key.

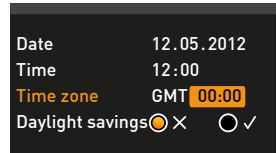

5. With the turn control, select the Daylight savings entry

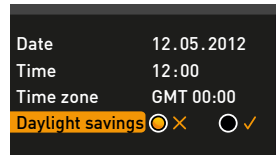
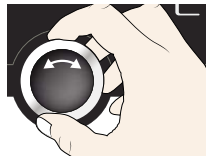

6. Accept the selection by pressing the confirmation key. The adjustment options are highlighted.

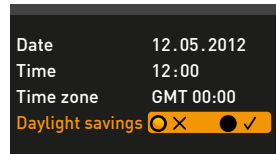
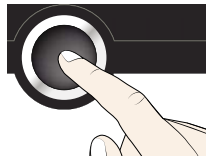

7. Set daylight savings to off (X) or on (✓) with the turn control – in this case on (✓). Save the setting by pressing the confirmation key.

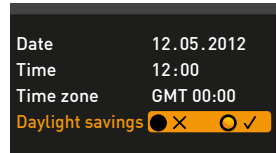

i Daylight saving time and standard time are not changed automatically. For this reason, please keep in mind to adjust them at the beginning of each period.

8. Now, set date (day, month year) and time (hours, minutes) in the same way. Accept the selection by pressing the confirmation key.

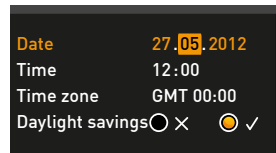

7.5 Calibrate

The appliances are temperature calibrated and adjusted at the factory. In case readjustment should be necessary later on – for example due to influence of the chamber load – the appliance can be calibrated customer-specifically using three calibration temperatures of your choice:

- ▶ Cal1 Temperature calibration at low temperature
- ▶ Cal2 Temperature calibration at medium temperature
- ▶ Cal3 Temperature calibration at high temperature

To guarantee perfect control, we recommend to calibrate the appliance once a year.

i For temperature adjustment, you will need a calibrated reference measuring device.

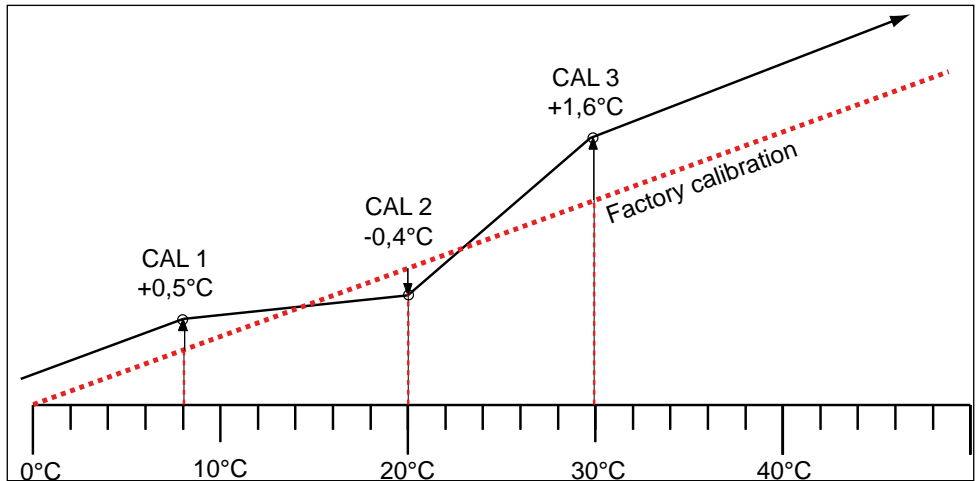
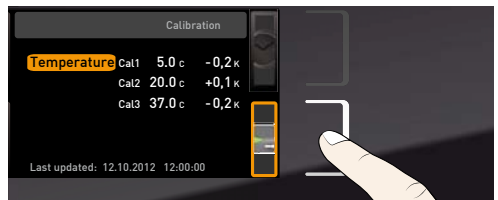

Fig. 23 Schematic example of temperature adjustment

Example: Temperature deviation at 30 °C should be corrected.

1. Press the activation key to the right of the **CALIB** display. The display is enlarged and the temperature adjustment option is automatically highlighted.
2. Press the confirmation key repeatedly, until the calibration temperature Cal2 is selected.



3. With the turn control, set the calibration temperature Cal2 to 30 °C.

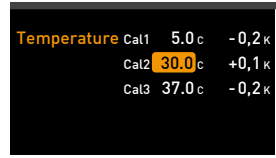

4. Save the setting by pressing the confirmation key. The corresponding calibration value is automatically highlighted.

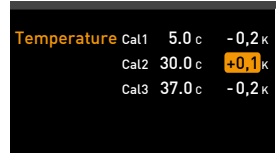
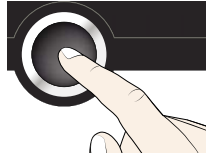

5. Set the calibration value to 0.0 K and accept the setting by pressing the confirmation key.



6. Position the sensor of a calibrated reference instrument centrally in the appliance's working chamber.

7. Close the door and, in manual mode, adjust the set temperature to 30 °C.

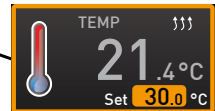
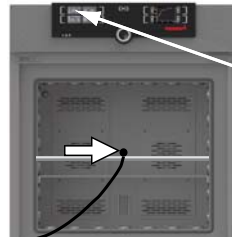

8. Wait until the appliance reaches the set temperature and displays 30 °C. The reference instrument should display 31.6 °C.

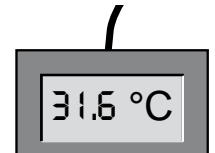
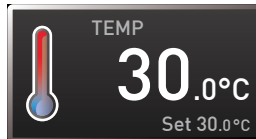

9. In the SETUP, adjust the calibration value Cal2 to +1.6 K (actual value measured minus setpoint temperature) and save the setting by pressing the confirmation key.



10. After the calibration procedure, the temperature measured by the reference instrument should now also be 30 °C.

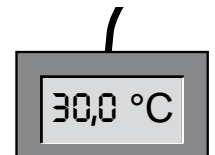
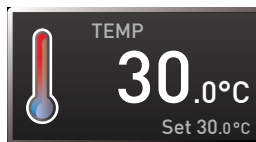

With Cal1, a calibration temperature below Cal2 can be programmed accordingly, and with Cal3, a temperature above. The minimum difference between the Cal values is 10 K.

i If all calibration values are set to 0.0 K, the factory calibration settings are restored.

7.6 Programmes

In the **PROG** display, you can transfer programmes created using AtmoCONTROL software and saved on a USB storage medium to the appliance. Here, you can also select the programme to be used in manual mode (see page 25) and delete programmes.

i To load a programme from a USB storage medium : Connect the USB storage medium with the saved programme(s) to the interface on the right side of the control panel.

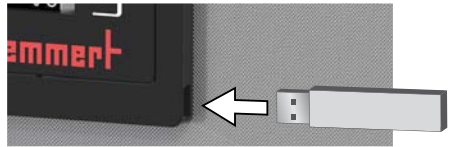

1. Activate the programme display. To do so, press the activation key on the left side of the **PROG** display. The display is enlarged and the entry **Select** automatically highlighted. The programmes available for activation are shown on the right. The programme currently available for use – in this example **Test 012** – is highlighted in orange.

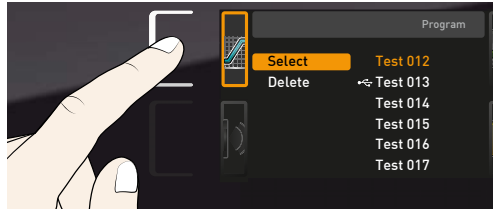

2. Call the **Select** function by pressing the confirmation key. All programmes available are displayed, including the ones saved on the USB storage medium (identified by the USB symbol). The programme currently available for use is highlighted in orange.

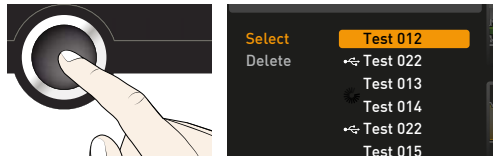

3. With the turn control, select the programme you want to make available for use.

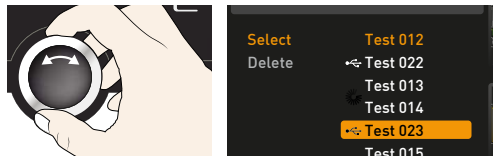

4. Accept the selection by pressing the confirmation key. The programme is now loaded, which is indicated by the transfer symbol.

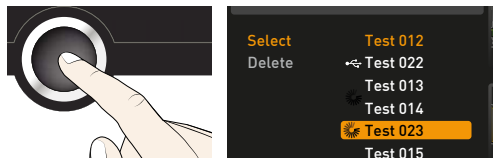

5. As soon as the programme is ready, the selection returns to **Select**. To start the programme: Return to manual mode by pressing the **MENU** key and start programme as described on page 45.

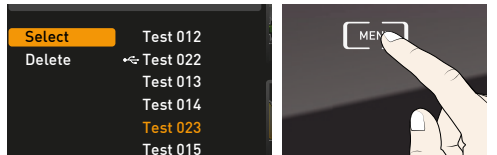

You can now remove the USB storage medium.

To delete a programme, select **Delete** with the turn control and select the programme to be deleted the same way you can select a programme for activation.

7.7 Sound

In the **SOUND** display, you can define whether or not the appliance should emit acoustic signals and, if yes, define on which events it should do so:

- ▶ on the press of a key
- ▶ at the end of a programme
- ▶ on alarm
- ▶ if the door is open

1. Activate the acoustic signal adjustment. To do so, press the activation key on the left side of the **SOUND** display. The display is enlarged. The first category (in this case **Key sound**) is automatically highlighted. On the right, the current settings are shown on.

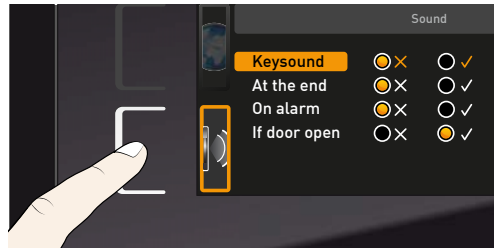

- i
 If you want to edit another list entry: Turn the turn control until the respective entry – e.g. **If door open** (Special accessories) – is highlighted in colour.

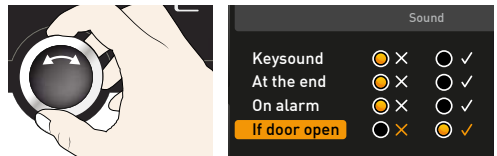

2. Save the selection by pressing the confirmation key. The adjustment options are automatically highlighted.

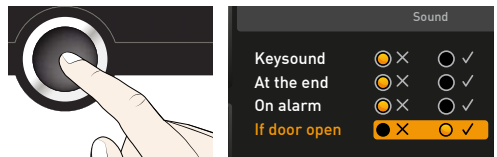

3. With the turn control, select the desired setting – in this example **OFF (X)**.

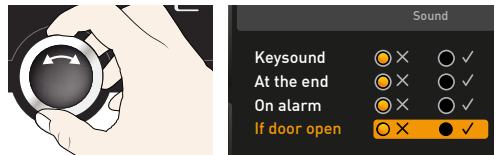

4. Save the setting by pressing the confirmation key.

- i
 If an acoustic alarm sounds, it can be turned off by pressing the confirmation key.

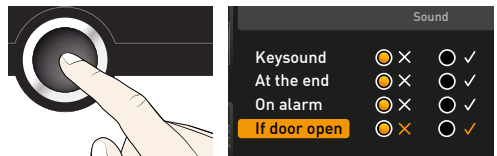

7.8 Protocol

The appliance continually logs all relevant measured values, settings and error messages at 1-minute intervals. The internal log memory is of the continuous memory type. The logging function cannot be switched off and is always active. The measured data are stored in the appliance, safe from manipulation. If the power supply is interrupted, the time of the power failure and voltage recovery are stored in the appliance.

You can export the protocol data for different periods to a USB storage medium via the USB interface or, via Ethernet, import them to the AtmoCONTROL software for graphical representation, print-out or storage.

i The log memory of the appliance is not modified or deleted by reading it out.

1. Connect the USB storage medium to the interface on the right side of the control panel.

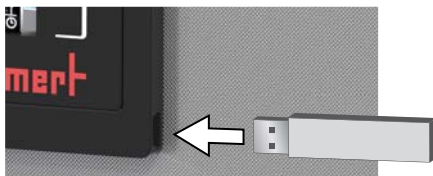

2. Activate the protocol. To do so, press the activation key on the right side of the **PROTOCOL** display. The display is enlarged and the period **This Month** automatically highlighted. To select another logging period, use the turn control.



3. Save your selection by pressing the confirmation key. The transfer starts and a status symbol indicates the progress.

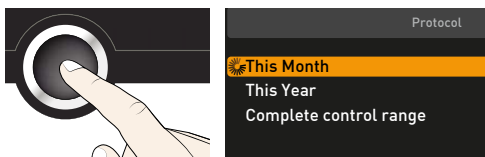

4. As soon as the transfer is complete, a check mark appears in front of the period selected. You can now remove the USB storage medium.

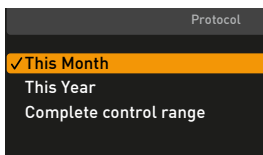

For a description of how to import and process protocol data in AtmoCONTROL or read them out via Ethernet, please observe the separate AtmoCONTROL manual.

7.9 User ID

7.9.1 Description

With the User-ID function, you can lock the settings of individual (e.g. temperature) or all parameters, so that they cannot be changed at the appliance by accident or unauthorised persons. You can also lock setting options in menu mode (e.g. adjustment or date and time settings) this way.

● If adjustment options are locked, this is indicated by the lock symbol in the respective display (Fig. 24).

User ID data are entered in the AtmoCONTROL software and saved on the USB storage medium. The USB storage medium is thus acting as a key: Parameters can only be locked or unlocked if it is connected.

● A description of how to create a user ID in AtmoCONTROL is provided in the separate AtmoCONTROL manual.

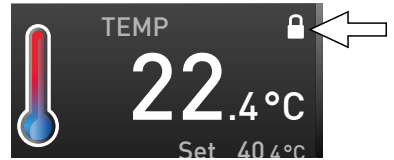
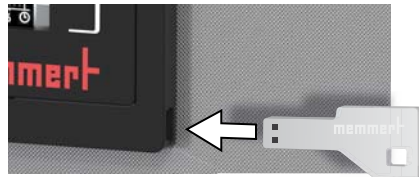

Fig. 24 Temperature adjustment at appliance locked (example)

7.9.2 User ID activation and deactivation

1. Connect the USB storage medium with the user ID data to the interface on the right side of the control panel.
2. Activate the user ID. To do so, press the activation key on the right side of the USER-ID display. The display is enlarged and the entry **Activate** automatically highlighted.



3. Confirm the activation by pressing the confirmation key. The new user ID data are transferred from the USB storage medium and activated. As soon as activation is complete, a check mark appears in front of the corresponding entry.
4. Remove the USB storage medium. Locked parameters are indicated by the lock symbol in the respective display (Fig. 24).

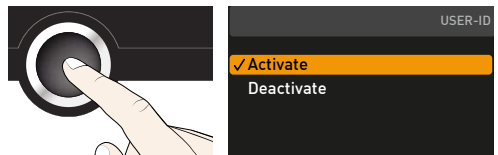
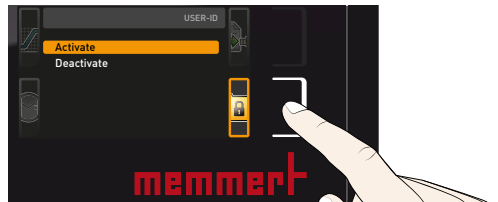

To unlock the appliance, connect the USB storage medium, activate the USER-ID entry and select **Deactivate**.

8. Maintenance and Servicing

**Warning!**

Danger due to electric shock. Before doing any maintenance work, pull out the mains plug.

**Warning!**

In case of appliances of a certain size, you can get accidentally locked in, which is life-threatening. Do not climb into the appliance!

**Caution!**

Danger of cuts due to sharp edges. Always wear gloves when working in the chamber interior.

To guarantee perfect control, we recommend to calibrate the appliance once a year (see page 43).

8.1 Cleaning

8.1.1 Interior and metal surfaces

Regular cleaning of the easy-to-clean interior prevents build up of material remains that could impair the appearance and functionality of the stainless steel chamber over time.

The metal surfaces of the appliance can be cleaned with normal stainless steel cleaning agents. Make sure that no rusty objects come into contact with the interior or with the stainless steel housing. Rust deposits can lead to an infection of the stainless steel. If rust spots should appear on the surface of the interior due to impurities, the affected area must be immediately cleaned and polished.

8.1.2 Plastic parts

Do not clean the ControlCOCKPIT and other plastic parts of the appliance with caustic or solvent-based cleaning agents.

8.1.3 Glass surfaces

Glass surfaces can be cleaned with a commercially available glass cleaner.

8.1.4 Cooling unit

In order to guarantee perfect function and a long lifetime of the refrigeration unit, it is absolutely essential to remove dust deposits from the condenser (with a vacuum cleaner, paintbrush or bottle brush, depending on the amount of dust).

To do so, open the screws at the lower front cover (number varies depending on the appliance size) and remove the front cover (Fig. 25).



Fig. 25 Unscrew and remove the front cover

8.2 Repairs and Service



Warning!

After removing covers, live parts may be exposed. You may receive an electric shock if you touch these parts. Disconnect the mains plug before removing any covers. Any work inside the appliance may only be performed by qualified electricians.



Repairs and service work are described in a separate service manual.

9. Storage and disposal

9.1 Storage

The appliance may only be stored under the following conditions:

- ▶ in a dry and enclosed, dust-free room
- ▶ frost-free
- ▶ disconnected from the power supply

9.2 Disposal

This product is subject to the Directive 2002/96/EC on Waste Electrical and Electronic Equipment (WEEE) of the European Parliament and of the Council. This appliance has been brought to market after August 13th, 2005 in countries which have already integrated this directive into their national laws. It may not be disposed of in normal household waste. For disposal, please contact your dealer or the manufacturer. Any appliances that are infected, infectious or contaminated with materials hazardous to health are excluded from return. Please also observe all other regulations applicable in this context.

Before disposing of the appliance, please render the door locking mechanism unusable, for example, to prevent playing children from being locked inside the appliance.

There is a lithium battery in the ControlCOCKPIT of the appliance. Remove it and dispose of it in accordance with the regulations in your country (Fig. 26).

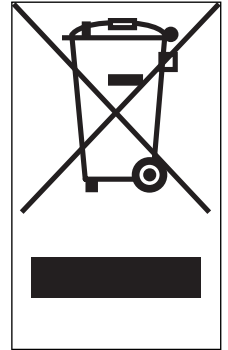

Fig. 26 Removing the lithium battery

Note for Germany:

The appliance may not be left at public or communal recycling or collection points.

Index

- A**
- Accessories 14
 - Acoustic signals 43
 - Activation key 23
 - Alarm 29, 30, 33
 - Ambient conditions 13
 - Ambient temperature 13
 - Appliance error 34
 - ASF 28, 30
 - AtmoCONTROL 3, 11, 13, 24, 26, 45, 47, 48
 - Automatic defrosting system 40
 - Automatic temperature monitor 30
- B**
- Balance 40
 - Basic device settings 36
 - Basic settings 36
- C**
- Calibrate 43
 - Carrying 15
 - Cause of errors 34
 - Chamber load 22
 - Changes 8
 - Cleaning 49
 - Clock time 41
 - Communication interfaces 10
 - Compensation correction values 44
 - Connections 10
 - ControlCOCKPIT 23
 - Cooling unit 40, 50
 - Customer service 2
- D**
- Date and time 40
 - Declaration of conformity 13
 - Defrost 40
 - Delete programme 45
 - Delivery 15, 16
 - Digital backwards counter 25
 - Dimensions 12
 - Disposal 51
 - Door 21
- E**
- Electrical connection 10
 - Electrical equipment 10
 - Electronic temperature monitoring 29
 - Emergency 8
 - Ending operation 32
 - End of programme 28
 - Error description 34
 - Error messages 33
 - Ethernet 11
 - Explosion protection 8
- F**
- Fan speed 25
 - Forklift truck 16
- G**
- Gateway 41
 - Graph 32
 - Grid 40
 - Guidelines 13
- H**
- Hazards 7
- I**
- Installation site 17
 - Intended use 8
 - Interfaces 10
 - IP address 38
- L**
- Language selection 37
 - Loading the appliance 22
- M**
- Maintenance 49
 - Malfunctions 8, 33, 34
 - Manufacturer 2
 - Material 10
 - Mechanical temperature monitoring 30
 - Menu 41
 - Menu mode 36
 - Minimum clearances 17
 - Monitoring function 28
 - Monitoring temperature 28
- N**
- Nameplate 11
 - Network 11, 38
- O**
- Operating 21
 - Operating modes 24
 - Operating personnel 7, 21
 - Operating problems 34
 - Operation 21
- P**
- Packaging material 16
 - Parameter adjustment 23
 - Power failure 35
 - Power supply 47
 - Press of a key 46
 - Product safety 7
 - Programme mode 24, 26
 - Programmes 45
 - Pt100 temperature sensor 28
- R**
- Rectifying errors 34
 - Remote control 41
- S**
- Safety regulations 6, 9
 - Service 50
 - Servicing 50
 - Setting up 15, 17
 - Setup 38
 - Shelf 40
 - Slide-in unit 40
 - Speaker symbol 29, 33
 - Standards 13
 - Storage after delivery 16
 - Switching off 32
 - Switching on 20

T

TB 30
Technical data 12
Temperature 25
Temperature comparison 43
Temperature deviation 43
Temperature limiter 30
Temperature monitor 28, 30
Temperature monitoring 28
Temperature sensor 28
Tilt protection 18
Timer 25
Timer mode 40
Transport 15, 16
Transport damage 16
Turn control 24
TWW 29
TWW temperature monitoring 29

U

Unit 39
Unpacking 16
USB interface 10, 47
User ID 48

W

Warning messages 10, 33
Weight 12



memmert
Experts in Thermostatics

Compressor-cooled incubator ICP

D30374 | Date 03/2017

englisch

Memmert GmbH + Co. KG
Willi-Memmert-Straße 90-96 | D-91186 Büchenbach
Tel. +49 9122 925-0 | Fax +49 9122 14585
E-Mail: sales@memmert.com
facebook.com/memmert.family
Die Experten-Plattform: www.atmosafe.net