

**Thermo Scientific
Heratherm
General Protocol
Microbiological Incubators**

IGS 60/100/180/400/750

Operating Instructions

50125554 B

14.06.12



© 2012 Thermo Fisher Scientific Inc. All rights reserved.

These operating instructions are protected by copyright. Rights resulting thereof, particularly reprint, photomechanical or digital postprocessing or reproduction, even in part, are only allowed with the written consent of Thermo Electron LED GmbH.

This regulation does not apply to reproductions for in-plant use.

The contents of this operating instructions manual may change at any time and without any prior notice. Concerning translations into foreign languages, the German version of these operating instructions is binding.

Trademarks

Heratherm[®] is a registered trademark of Thermo Scientific.

Thermo Scientific is a brand owned by Thermo Fisher Scientific Inc.

All other trademarks mentioned in the operating instructions are the exclusive property of the respective manufacturers.

Thermo Electron LED GmbH

Robert-Bosch-Straße 1

D - 63505 Langenselbold

Germany

Thermo Electron LED GmbH is an affiliate to:

Thermo Fisher Scientific Inc.

81 Wyman Street

Waltham, MA 02454

USA

Thermo Fisher Scientific Inc. provides this document to its customers with a product purchase to use in the product operation. This document is copyright protected. and any reproduction of the whole or any part of this document is strictly prohibited, except with the written authorization of Thermo Fisher Scientific Inc.

The contents of this document are subject to change without notice.

All technical information in this document is for reference purposes only. System configurations and specifications in this document supersede all previous information received by the purchaser.

Thermo Fisher Scientific Inc. makes no representations that this document is complete, accurate or error-free and assumes no responsibility and will not be liable for any errors, omissions, damage or loss that might result from any use of this document, even if the information in the document is followed properly.

This document is not part of any sales contract between Thermo Fisher Scientific Inc. and a purchaser. This document shall in no way govern or modify any Terms and Conditions of Sale, which Terms and Conditions of Sale shall govern all conflicting information between the two documents.

Contents

Chapter 1	Safety Notes	1-1
	Basic operating precautions	1-1
	Operational Safety Rules	1-2
	Warranty	1-2
	Explanation of Safety Information and Symbols	1-3
	Safety Notes and Symbols Used Throughout These Operating Instructions	1-3
	Additional symbols for safety information	1-4
	Symbols on the Incubator	1-5
	Intended Purpose of the Incubator	1-5
	Intended Purpose of the Incubator	1-5
	Incorrect Use	1-5
	Standards and Directives	1-5
Chapter 2	Delivery of the Incubator	2-1
	Packaging	2-1
	Acceptance inspection	2-1
	Scope of supply	2-2
Chapter 3	Installation	3-1
	Ambient conditions	3-1
	Location requirements	3-1
	Intermediate Storage	3-2
	Room Ventilation	3-2
	Space Requirements	3-3
	Installation Built-in Units	3-4
	Table-top units	3-5
	Floor stand units	3-6
	Transport	3-8
	Stacking Kit	3-10
	Installing the Stacking Feet	3-10
	Installing the Stacking Adapter	3-11
	Installing the Anti-tilt Anchor	3-11
	Floor stand unit spacers	3-14
Chapter 4	Product Description	4-1
	Heratherm IGS Series Incubator Overview	4-1
	Safety Devices	4-8
	Work Space Atmosphere	4-8
	Sensing and Control System	4-8
	Data Communications & Alarm Interface	4-9
	RS 232 interface	4-9

Contents

AC Power Socket.....	4-10
Fuses.....	4-10
Work Space Components.....	4-10
Inner Chamber.....	4-10
Access Port.....	4-10
Tube Access Ports.....	4-12
Chapter 5 Start-up.....	5-1
Installing the Shelf System for Table-top units.....	5-1
Initial installation.....	5-1
Installing the Perforated Shelves.....	5-2
Preparing the Work Space.....	5-2
Installation of the Support Rails (only for Table-top Units).....	5-3
Installing the Shelf Support Brackets.....	5-3
Installing the Perforated Shelves.....	5-4
Installing/Removing air baffles.....	5-5
Levelling the Table-top Incubator.....	5-6
Connecting Power.....	5-6
Connection to the Power Supply Source.....	5-6
Connecting the RS-232 Interface.....	5-7
Interconnecting the Incubator with a Computer.....	5-8
Chapter 6 Operation.....	6-1
Preparing the Incubator.....	6-1
Starting Operation.....	6-1
Chapter 7 Handling and Control.....	7-1
Powering Up.....	7-5
Switching the Incubator Off / Powering Down.....	7-5
Temperature Set Value.....	7-6
Timer.....	7-7
Stopping a timer.....	7-8
Settings.....	7-10
Error Log.....	7-10
Calibration.....	7-11
Temperature Display Unit.....	7-12
Chapter 8 Shut-down.....	8-1
Shutting the Incubator Down.....	8-1
Chapter 9 Cleaning and disinfection.....	9-1
Cleaning.....	9-1
Cleaning Exterior Surfaces.....	9-1
Wipe / spray disinfection.....	9-1
Preparing the manual wipe/spray disinfection.....	9-2
Predisinfection.....	9-3
Cleaning.....	9-3
Final Disinfection.....	9-3

Chapter 10 Maintenance.....10-1

- Inspections and Checks 10-1
 - Regular Checks.....10-1
 - Semi-annual Inspection 10-1
- Service Intervals.....10-2
 - 3-monthly service 10-2
 - Annual service 10-2
- Preparing Temperature Calibration 10-2
- Comparison Measurement Procedure..... 10-3
- Temperature Calibration Procedure 10-3
- Replacing the Door Seal..... 10-4
- Replacing the Power Cord..... 10-4
- Returns for Repair 10-5

Chapter 11 Disposal.....11-1

- Overview of materials used 11-1

Chapter 12 Error Codes.....12-1

Chapter 13 Technical Data13-1

Chapter 14 Spare Parts and Accessories14-1

Chapter 15 Device Log15-1

Chapter 16 Contact16-1

List of Figures

Figure 3-1 Table-top incubator, dimensions and required clearances	3-5
Figure 3-2 Floor stand incubator, dimensions and required clearances	3-6
Figure 3-3 Floor stand incubator, dimensions and required clearances	3-7
Figure 3-4 Lift Points.....	3-8
Figure 4-1 Heratherm IGS 60/IGS 100/IGS 180 Front View.....	4-2
Figure 4-2 Heratherm IGS 60/IGS 100/IGS 180 Rear View	4-3
Figure 4-3 Heratherm IGS 400 Front View.....	4-4
Figure 4-4 Heratherm IGS 400 Rear View.....	4-5
Figure 4-5 Heratherm IGS 750 Front View.....	4-6
Figure 4-6 Heratherm IGS 750 Rear View.....	4-7
Figure 4-7 Sensor System (for table-top units)	4-8
Figure 4-8 Sensor System (for floor stand units)	4-8
Figure 4-9 Signal Interfaces and Power Socket.....	4-9
Figure 4-10 Shelf System	4-11
Figure 4-11 Tube Access Ports.....	4-12
Figure 5-1 Sliding the Retaining Spring into the Support Rail.....	5-1
Figure 5-2 Installing the Shelving	5-2
Figure 5-3 Support Rail Installation.....	5-3
Figure 5-4 Shelf Support Installation	5-4
Figure 5-5 Installing the Perforated Shelves	5-4
Figure 5-6 Removing the bottom plate	5-5
Figure 5-7 Removing the left and right support profiles.....	5-5
Figure 5-8 Removing the rear air baffle IGS 400 / 750	5-5
Figure 5-9 AC Power Supply Socket.....	5-7
Figure 7-1 Control Panel for Heratherm IGS Series Incubators	7-1
Figure 10-1 Door Seal Replacement	10-4

List of Figures

Safety Notes

Basic operating precautions

These operating instructions describe Heratherm incubators.

Heratherm incubators have been manufactured to the latest state of the art and have been tested thoroughly for flawless functioning prior to shipping. However, the incubator may present potential hazards, particularly if it is operated by inadequately trained personnel or if it is not used in accordance with the intended purpose. Therefore, the following must be observed for the sake of accident prevention:

- Heratherm incubators must be operated by adequately trained and authorized professional personnel.
- Heratherm incubators must not be operated unless these operating instructions have been fully read and understood.
- The present operating instructions, applicable safety data sheets, plant hygiene guidelines and the corresponding technical rules issued by the operator shall be used to create written procedures targeted at personnel working with the subject matter device, detailing:
 - the decontamination measures to be employed for the incubator and the accessories used with it,
 - the safety precautions to be taken when processing specific agents,
 - the measures to be taken in case of accidents.
- Repair work on the incubator must be carried out only by trained and authorized expert personnel.
- The contents of these operating instructions are subject to change at any time without further notice.
- Concerning translations into foreign languages, the German version of these operating instructions is binding.
- Keep these operating instructions close to the incubator so that safety instructions and important information are always accessible.
- Should you encounter problems that are not detailed adequately in these operating instructions, please contact Thermo Electron LED GmbH immediately for your own safety.

Operational Safety Rules

The following rules must be heeded when working with Heratherm incubators:

- Observe the sample weight limits specified for your Heratherm incubator as a whole and its shelving in particular; see “[Technical Data](#)” on [page 13-1](#)).
- Do not load the bottom of the interior workspace to avoid the risk of overheating any samples placed there and to prevent the temperature sensor from being damaged.
- Arrange the samples evenly throughout the work space, making sure not to place them too closely to the interior walls to ensure a uniform temperature distribution.
- Do not load your Heratherm incubator with substances that exceed the capabilities of the available lab apparatus and Personal Protection Equipment to provide sufficient degrees of protection to users and third parties.
- Check the door seal every six months for proper sealing performance and possible damage.
- Do not process any samples containing hazardous chemical substances that may be released into the ambient air through defective seals or may cause corrosion or other defects on parts of the Heratherm incubator.

Warranty





Thermo Fisher Scientific warrants the operational safety and functions of the Heratherm incubators only under the condition that:

- the incubator is operated and serviced exclusively in accordance with its intended purpose and as described in these operating instructions,
- the incubator is not modified,
- only original spare parts and accessories that have been approved by Thermo Electron LED GmbH are used (third-party spares without Thermo Electron LED GmbH approval void the limited warranty),
- inspections and maintenance are performed at the specified intervals,
- an operation verification test is performed after each repair activity.



The warranty is valid from the date of delivery of the incubator to the customer.

Explanation of Safety Information and Symbols

Safety Notes and Symbols Used Throughout These Operating Instructions

	 <p>Indicates a hazardous situation which, if not avoided, will result in death or serious injuries.</p>
	 <p>Indicates a hazardous situation which, if not avoided, could result in death or serious injuries.</p>
	 <p>Indicates a situation which, if not avoided, could result in damage to equipment or property.</p>
	 <p>Is used for useful hints and information regarding the application.</p>

Additional symbols for safety information

	Wear safety gloves!
	Wear safety goggles!
	Harmful liquids!
	Electric shock!
	Hot surfaces!
	Fire hazard!
	Explosion hazard!
	Suffocation hazard!
	Biological hazard!
	Contamination hazard!
	Danger of tipping!

Symbols on the Incubator



Observe operating instructions



VDE test mark



CE-conformity mark: confirms conformity according to EU Guidelines

Intended Purpose of the Incubator

Intended Purpose of the Incubator

Heratherm incubators are laboratory devices for preparing and cultivating cell and tissue cultures. The devices employ precision temperature control for simulating the specific physiological ambient conditions for these cultures.

Incorrect Use

To avoid the risk of explosion do not load the incubator with tissue, material, or liquids that:

- are easily flammable or explosive,
- release vapor or dust that forms combustible or explosive mixtures when exposed to air,
- release poisons,
- release dust,
- exhibit exothermic reactions,
- are pyrotechnical substances.
- Refrain also from pouring any liquids onto the internal base plate or inserting bowls filled with liquids into the sample compartment.

Standards and Directives

The incubator complies with the following standards and guidelines:

- IEC EN 61010 - 1, IEC EN 61010 - 2 - 010

Safety Notes
Standards and Directives

- Low Voltage Directive 2006/95/EC
- EMC Directive 2004/108/EC

Additionally, the incubator is in compliance with many other international standards, regulations and directives not listed here. Should you have any questions regarding compliance with national standards, regulations and directives applicable for your country, please contact your Thermo Fisher Scientific sales organization.

Delivery of the Incubator

Packaging

Heratherm incubators are delivered in a rugged packaging box. All packaging materials can be separated and are reusable:

Packaging materials

Packaging carton: Recycled paper

Foam elements: Styrofoam (CFC-free)

Pallet: Chemically untreated wood

Packaging film: Polyethylene

Packaging ribbons: Polypropylene

Acceptance inspection

After the incubator has been delivered, check the delivery immediately for:

- completeness,
- possible damage.

If components are missing or damage is found on the device or the packaging, in particular damage caused by humidity and/or water, please notify the carrier as well as Thermo Scientific Technical Support immediately.

	 WARNING	Risk of injury
<p>Should sharp edges have formed in damaged areas or elsewhere on the device, take all necessary precautions to protect personnel handling the incubator. For example, have them wear protective gloves and other personal protection equipment.</p>		

Scope of supply

Incubators

Quantity of components supplied (pieces)	IGS Series
Perforated shelves	2
Support rail for shelf table-top units	4
Shelf support	4
Power cord	1
Clip springs for table-top units	4
Anti-tilt anchor	1
Operating manual	1
Short reference guide	1

Installation

Ambient conditions

Location requirements

Built-in units of incubators can, heating and drying ovens must be operated with an air exhaust system and exhaust hose (only original Thermo accessory should be used).

For safety reasons, the installation space should be made of non-combustible materials, according to DIN 4102.



NOTE

During installation of built-in units, ensure that the escaping air will be safely discharged out of the installation space.

The incubator must only be operated in a location that meets all of the ambient condition requirements listed below:

- Installation location indoors in dry areas free from drafts.
- The dust burden may not exceed the contamination category 2 based on EN 61010-1. Using the incubator in an atmosphere with electrically conductive dust is prohibited.
- The minimal distance to adjacent surfaces must be observed on all sides (see section “Space Requirements” on page 3-3).
- The operating room must be equipped with appropriate ventilation.
- Solid, level, fire-proof surface; no flammable materials opposite to the rear panel of the incubator.
- Vibration-proof substructure (floor stand, lab table) capable of bearing the dead weight of the incubator and its accessories (in particular when stacking the table-top units).
- The electrical circuitry of the incubator has been designed for an operating height of up to 2000 m above sea level.
- Relative humidity up to 80% (maximum; preferably 60-70%), non condensing.
- Condensation must be avoided - for example, after moving or transporting the device. Should condensation exist, wait until the moisture has evaporated completely before connecting the incubator to a power source and powering up.
- The ambient temperature must be within a range of +18 °C to +32 °C (64.4 °F to 89.6 °F).

- Avoid direct exposure to sunlight.
- Devices that produce excessive amounts of heat must not be placed near the incubator.
- The table-top incubator should not be operated directly on the floor of the lab, but must be placed on a substructure (optional: must be ordered separately). This prevents the penetration of dust or dirt into the device.
- Power line voltage variations must not exceed $\pm 10\%$ of the nominal voltage.
- Transient surges must lie within the range of levels that normally occur in the power supply system. The impulse withstand voltage based on surge category II of IEC 60364-4-443 shall be applied at the nominal voltage level.
- Consider installing one dedicated upstream circuit breaker per incubator to avoid multiple device failures in case of an electrical fault.

	 WARNING	Contamination hazard
<p>Do not place the incubator directly on the lab floor, but mount it on the floor stand or on a lab work surface (option; to be ordered separately). Contaminants, such as bacteria, viruses, fungi, prions, and other biological substances may use the open door to migrate easily from the floor into the incubator's work space.</p>		

Intermediate Storage

When the incubator is placed in intermediate storage, which is permissible for a maximum of four weeks, make sure that the ambient temperature is between 20 °C to 60 °C (68 °F to 140 °F) and the maximum relative humidity does not exceed 90%, non-condensing.

Room Ventilation

Heat dissipating from the incubator during continuous operation may cause a change in the room climate.

- Therefore, the incubator must only be installed in rooms with sufficient ventilation.
- Do not install the incubator in room recesses without ventilation.
- When several devices are to be placed in the same room, additional ventilation may have to be provided as necessary.
- To avoid any impact of the heat dissipated by the incubator on the ambient climate the room must be vented by means of a laboratory-grade ventilation system that complies with applicable local and national health and safety regulations and has sufficient capacity.
- If excessive temperatures tend to occur in the operating room, be sure to provide a thermal protection means that cuts out the power supply to mitigate the impact of overtemperature scenarios.

Space Requirements

For built-in units following clearances should be kept:



Abb. 3

A, B, C and D see Operating Instructions of the unit.

E (mm/inch)	F (mm/inch)	G (mm/inch)	H (mm/inch)
100 / 4	50 / 2	80 / 3,2	30 / 1,2

Installation Built-in Units

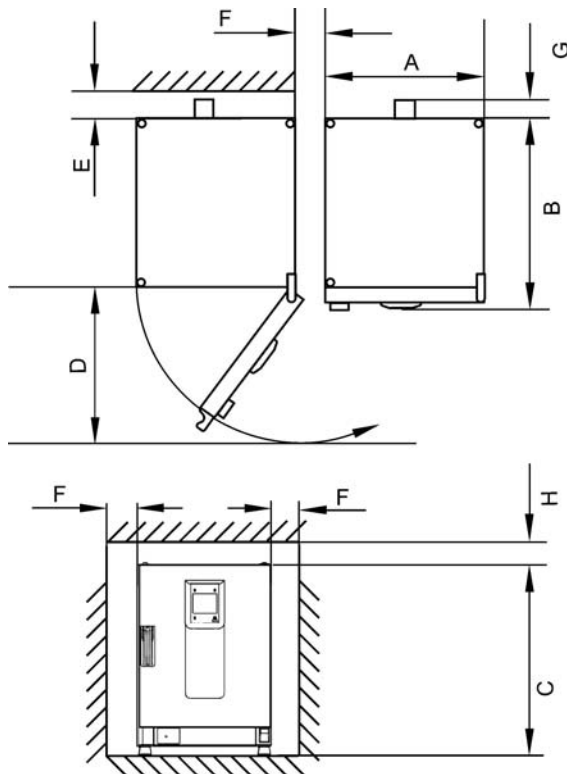
IGS	Clearances, as Fig. 3, without exhaust hose.
IMH/IMH-S	Clearances, as Fig. 3, close air port with plug, supplied with the unit.
OGS/OMS	Clearances, as Fig. 3, with additional space to operate to air slide, with air exhaust system and exhaust hose Ø 40 mm (1.58 in)/1.5 m (59 in) (original Thermo accessory), shortened to required length, installed according to Fig. 1 and 2.
OGH/OGH-S OMH/OMH-S	Clearances, as Fig. 3, with air exhaust system and exhaust hose Ø 40 mm (1.58 in)/1.5 m (59 in) (original Thermo accessory), shortened to required length, installed according to Fig. 1 and 2, Operating temperature up to max. 250 °C (482 °F).

NOTE

After connecting the built-in unit to the electrical power supply, avoid damaging the power cord, then sliding into the installation position.

When installing the incubator, make sure that the installation and supply connections remain freely accessible.

The specified side clearances represent minimum distances.

Table-top units

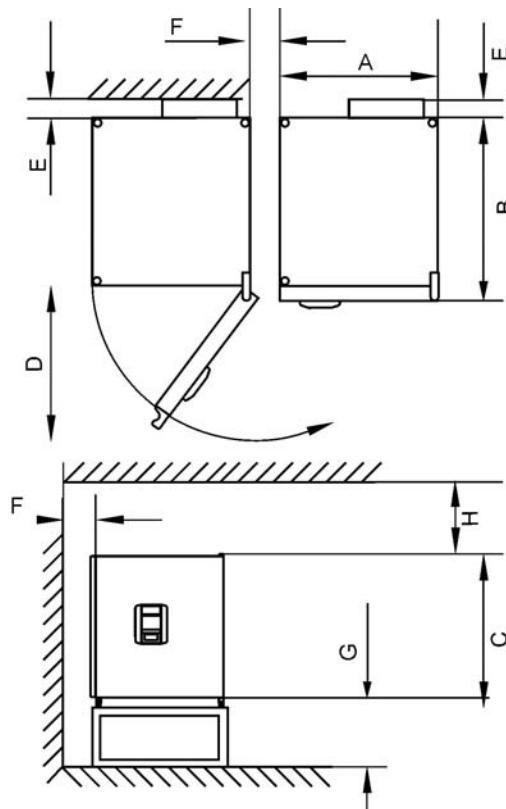

Figure 3-1 Table-top incubator, dimensions and required clearances

Table 3-1 Incubator Dimensions

Model	A (mm/inch)	B (mm/inch)	C (mm/inch)	D (mm/inch)
IGS 60	530/20.1	565/22.2	720/28.3	540/21.3
IGS 100	640/25.2	565/22.2	820/32.3	650/25.6
IGS 180	640/25.2	738/29.1	920/36.2	650/25.6

* Depth of handle /display (66 mm/2.6 in) not included in overall depth specified; height of adjustable feet (36 mm/1.4 in) not included in overall height specified.

Table 3-2 Required Clearances

E (mm/inch)	F (mm/inch)	G (mm/inch)	H (mm/inch)
80/3.1	50/2.0	200/7.9	300/11.8

Floor stand units

400 liter units

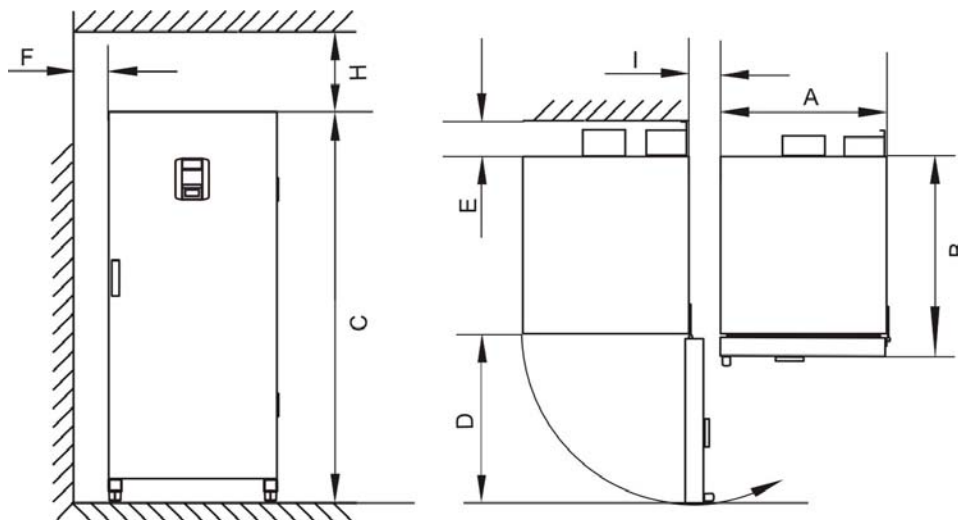

Figure 3-2 Floor stand incubator, dimensions and required clearances

Table 3-3 Incubator Dimensions

Model	A (mm/inch)	B (mm/inch)	C (mm/inch)	D (mm/inch)
IGS 400	755/29.7	770/30.3	1655/65.2	810/31.9

* Depth of handle /display (66 mm/2.6 in) not included in overall depth specified. Width of hinge (23 mm) not included in overall width.

Table 3-4 Required Clearances

E (mm/inch)	F (mm/inch)	H (mm/inch)	I (mm/inch)
120 / 4.7	50 / 2	200 / 7.9	200 / 7.9

750 liter units

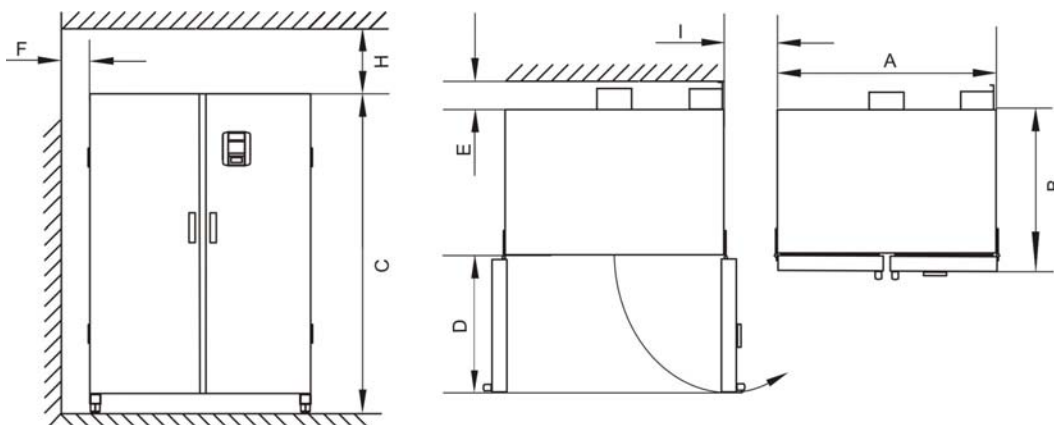

Figure 3-3 Floor stand incubator, dimensions and required clearances

Table 3-5 Incubator Dimensions

Model	A (mm/inch)	B (mm/inch)	C (mm/inch)	D (mm/inch)
IGS 750	1215 / 47.8	770 / 30.3	1655/65.2	670 / 26.4

* Depth of handle /display (66 mm/2.6 in) not included in overall depth specified. Width of hinge (23 mm) not included in overall width.

Table 3-6 Required Clearances

E (mm)	F (mm)	H (mm)	I (mm)
120/4.7	50 / 2.0	200 / 7.9	350 / 13.8

Transport

Table-top units

For transport, do not lift the incubator using the doors or components attached to the incubator as lift points.

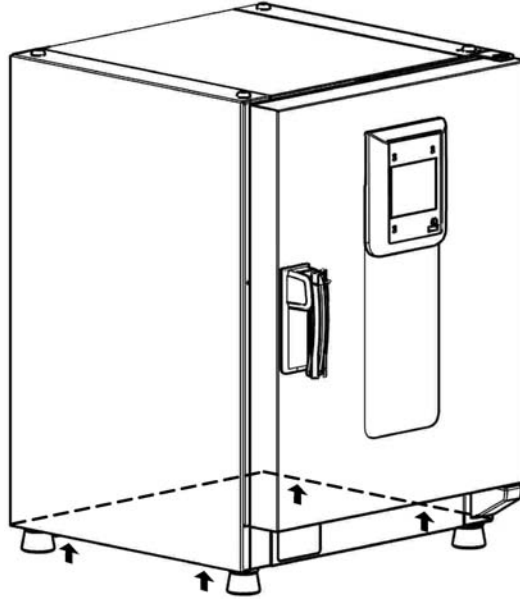

Figure 3-4 Lift Points



	<p> CAUTION Heavy loads! Lift with care!</p> <p>To avoid injury through physical strain, such as strain traumata and slipped discs, do not attempt to lift the incubator alone!</p> <p>To avoid injury through dropped loads, be sure to wear Personal Protection Equipment, such as safety shoes, when lifting the incubator.</p> <p>To avoid crushing your fingers or hands (particularly in a closing door) or damaging the incubator, do not use any other lift points than those indicated in the illustration above.</p>
--	--

Floor stand units



The floor stand units come equipped with four (4) casters. The lever for releasing the caster is located above the locking lever. After positioning the unit in its installation location ensure that the locking levers are pressed down on the casters.

To ensure the degree of stability specified by safety requirements the front casters must be turned so that they are facing forward after the unit has been positioned in its installation location and the locking levers pressed down on these casters.

	<div style="border: 1px solid black; padding: 5px; margin-bottom: 10px;">  Danger of tipping when moving! </div> <p>Before moving the unit, ensure that it has been unplugged.</p> <p>Move the Heratherm floor stand units with caution.</p> <p>Quick starts and stops can result in tipping!</p> <p>Always ensure that the doors are closed when moving the unit.</p>
--	--

Stacking Kit

The stacking adapter is available only for table-top units.

Material Number	Description
50126665	Stacking adapter Heratherm 60L
50126666	Stacking adapter Heratherm 100L
50126667	Stacking adapter Heratherm 180L

Scope of Delivery:

1 stacking adapter

1 anti-tilt anchor

1 plastic bag with 2 stacking feet and 2 M4x16 Torx screws.

Required Tools:

Slotted screwdriver 5,5x100 or Torx screwdriver 20x100.

Installing the Stacking Feet

Remove the left and right blank plugs at the top blank.

Install the stacking feet with the enclosed screws using a slotted or Torx screwdriver.

Installing the Stacking Adapter

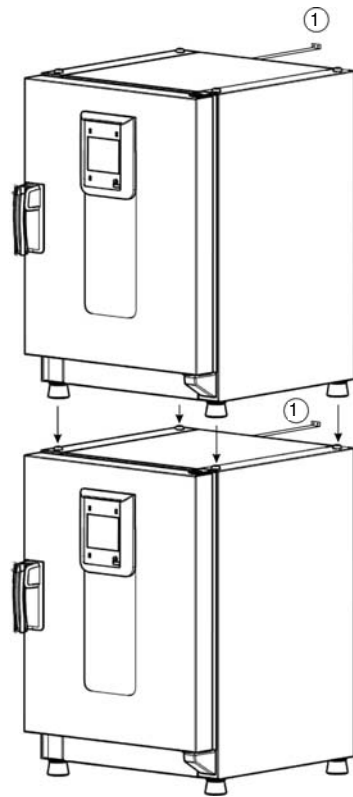

1	Anti-tilt anchor
---	------------------

Stack as follows when using a stacking adapter (numbers denote incubator volumes in liters):

- for 60 l or 100 l on 180 l use stacking adapter Heratherm 180L,
- for on 100: use stacking adapter Heratherm100L.

To prevent the top device from slipping and dropping down, the following requirements must be fulfilled before devices may be stacked:

- Only two units may be stacked together. When stacking devices with the same type of enclosure, yet with a different footprint the device with the smaller footprint must be placed on top of the one with the larger footprint at all times.
- The bottom device must be correctly levelled.
- Be sure to use the appropriate stacking adapter.
- The levelling feet on the top device must be screwed in all the way.
- The levelling feet of the top device must be aligned with and placed exactly on the stacking pads of the stacking adapter.
- The anti-tilt anchor must be installed on the top device.

Installing the Anti-tilt Anchor

Table-top units

The anti-tilt anchor secures the top device in a stack to a solid part of a building. The anti-tilt anchor is to be mounted on the side opposite of the door hinges.

Installation Installing the Anti-tilt Anchor

Bend the fixing tabs of the anti-tilt anchor up on one side and down on the other by an angle of approx. 90°.

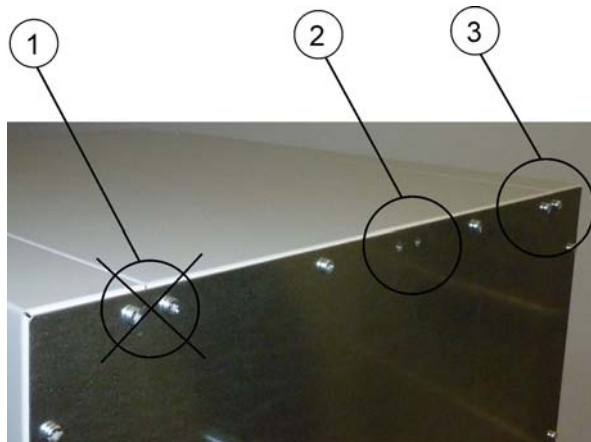

1. Do not use this position if the door is hinged on this side. Right-hand hinges represent the standard configuration.
2. Preferred position.
3. Alternative position. Do not use if the door is hinged on this side.

Remove the bracket screws. Use the preferred position, if possible.

Fix the anti-tilt anchor with the bracket side down to the unit (see figure).

Position the unit with the anti-tilt anchor to in an angle of approx. 90° +/- 20%.

Take care that the stacking feet of the unit are still in correct place on the lower unit or on the stacking adapter.

Fix the anti-tilt anchor to a solid part of the building.





Unsafe part of the building!

Install the anti-tilt anchor to a solid part of the building, which is able for shoring loads.

The installation has to be carried out by qualified personnel only.

The connection to the building must be carried out with appropriate screws and dowels according to the consistence of the building part.

Additionally, the following caution notes must be heeded at all times:

	<p> CAUTION Risk of overheating with stacked devices</p> <p>To avoid the risk of electrical components and the outer enclosure overheating or temperature control failing due to insufficient ventilation, do not exceed the specified stacking height!</p>
	<p> CAUTION Risk of tipping and dropping of stacked devices</p> <p>You should be aware at all times that stacked devices do not form a stable unit, even when the stacking pads and frames are used correctly. The top device may tip over and drop down when being transported in a stack. To avoid injury to persons and damage to equipment, do not attempt to move stacked devices as a unit! Separate and move each device one by one, then restack them.</p> <p>Thermo Scientific accepts no responsibility or liability whatsoever with regard to stacked third party devices; this is at the user's own risk.</p>

Floor stand units

	<p> NOTE</p> <p>Heratherm floor stand units must always be attached to the wall using two (2) retaining brackets on the outer left and right side on the back of the unit.</p>
--	--



Remove the screws.

Attach the end of the retaining bracket that is facing downward to the unit.

Align the device at roughly 90°, +/-20° to the retaining bracket.

Affix the retaining bracket to the wall.



Load carrying capacity of building items!

Attach the retaining brackets to a solid building item that can accommodate the associated loads.

Installation may only be performed by qualified personnel.

The screws and anchors used for connection must be appropriate for the design and condition of the building item.

Floor stand unit spacers

The spacer on the electrical module must be pulled out and fixed in place before installing the floor stand unit at its installation location.



- 1 Loosen the 2 screws
- 2 Pull out the spacer and slide the screws into the recesses
- 3 Tighten the two screws

Product Description

This section describes IGS Series Heratherm general protocol microbiological incubators for standard laboratory applications.

Heratherm IGS Series Incubator Overview

IGS Series general protocol microbiological natural convection incubators come equipped with the following features:

- high-precision work space temperature control, adjustable in steps of one-tenth of a degree up to 75 °C (167 °F)
- two perforated shelves
- access port for table top units
- inlet and exhaust air tube for floor stand units

The individual features of IGS Series incubators are shown in the figures below.

Product Description
Heratherm IGS Series Incubator Overview

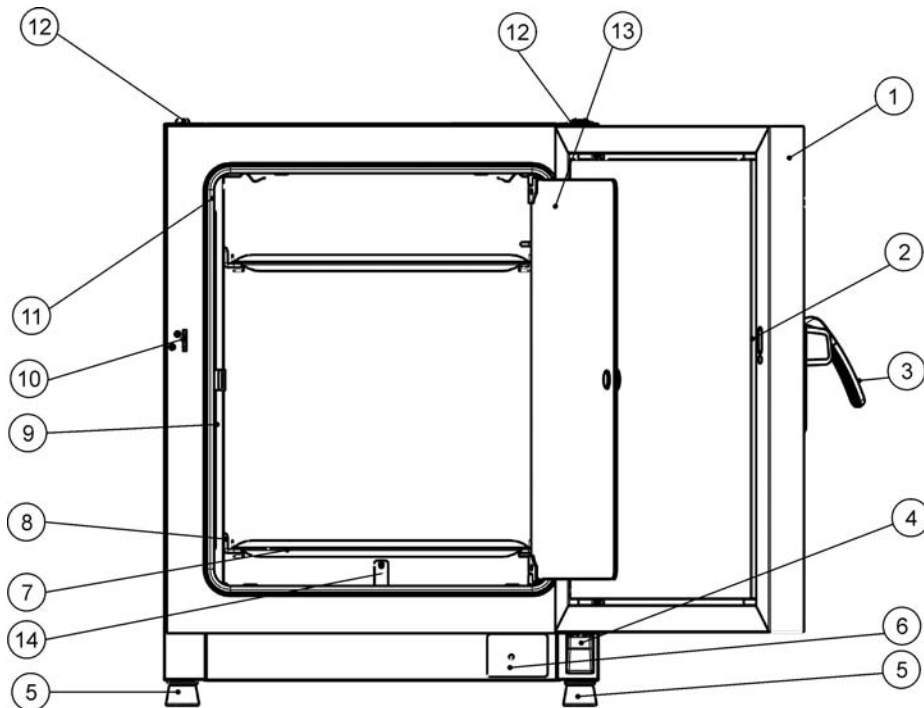

Figure 4-1 Heratherm IGS 60/IGS 100/IGS 180 Front View

- [1] Outer door
- [2] Door latch cutout
- [3] Door latch and handle
- [4] Door hinge, lower
- [5] Levelling foot
- [6] Nameplate
- [7] Perforated shelf
- [8] Support rail for perforated shelf
- [9] Shelf support
- [10] Door hook catch
- [11] Door seal
- [12] Stacking pad
- [13] Glass door
- [14] Temperature sensor

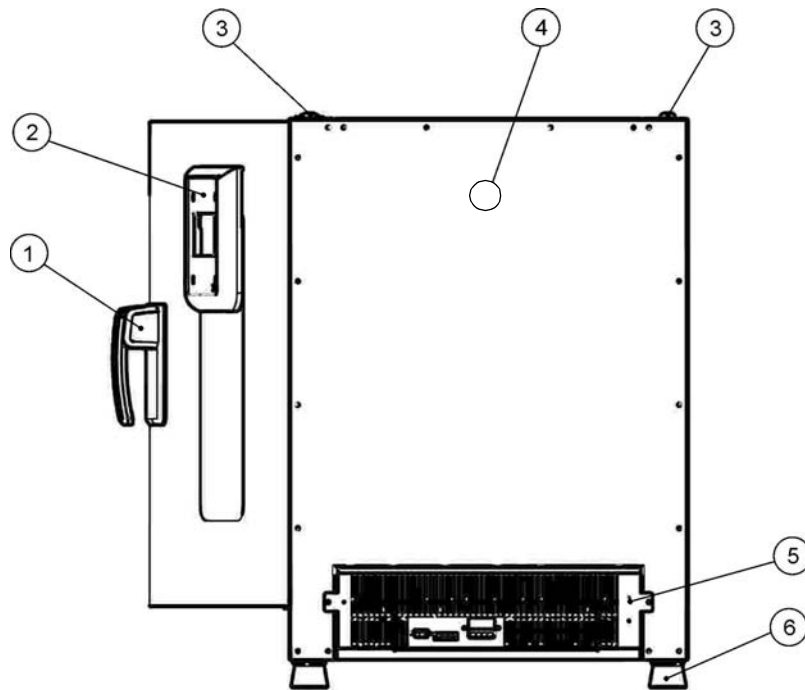

Figure 4-2 Heratherm IGS 60/IGS 100/IGS 180 Rear View

- [1] Door latch and handle
- [2] Control panel
- [3] Stacking pad
- [4] Access port
- [5] Electronics compartment
- [6] Levelling foot

Product Description
Heratherm IGS Series Incubator Overview

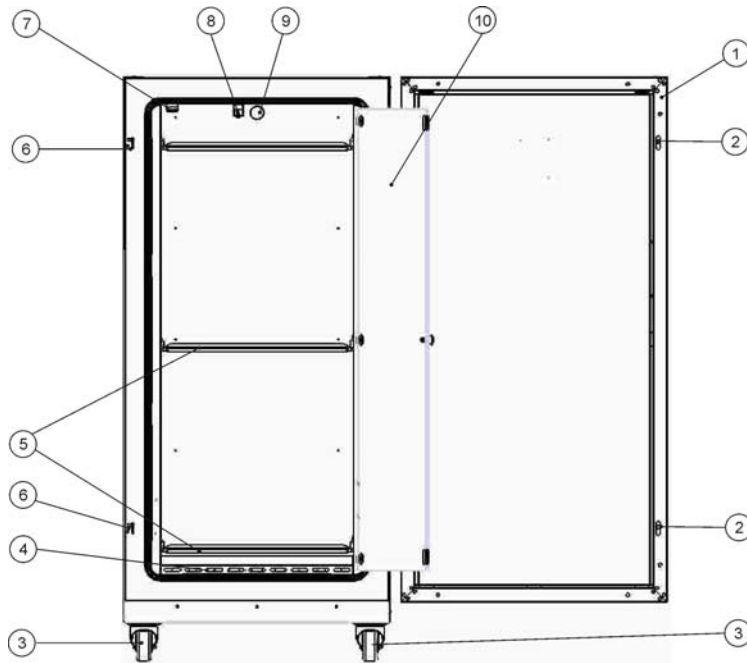

Figure 4-3 Heratherm IGS 400 Front View

- [1] Outer door
- [2] Door latch
- [3] Unit caster
- [4] Air baffle
- [5] Perforated shelf
- [6] Door hook catch
- [7] Glass door latch
- [8] Temperature sensor
- [9] Exhaust air tube
- [10] Glass door

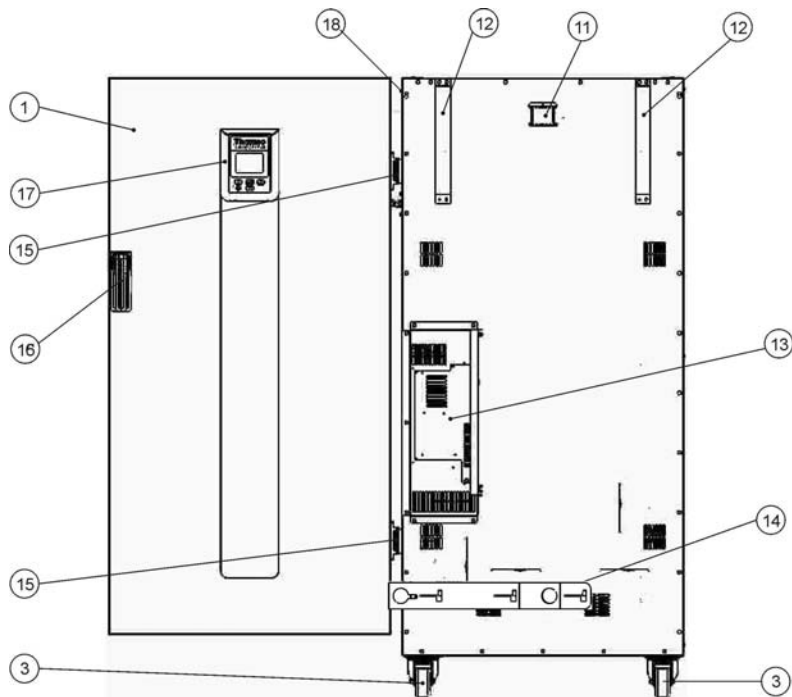

Figure 4-4 Heratherm IGS 400 Rear View

- [1] Outer door
- [2] -
- [3] Unit caster
- [4] -
- [5] -
- [6] -
- [7] -
- [8] -
- [9] -
- [10] -
- [11] Exhaust air tube
- [12] Anti-tilt anchor
- [13] Electronic compartment
- [14] Inlet air tube
- [15] Hinge
- [16] Door handle
- [17] Display
- [18] Nameplate on sidewall

Product Description
Heratherm IGS Series Incubator Overview

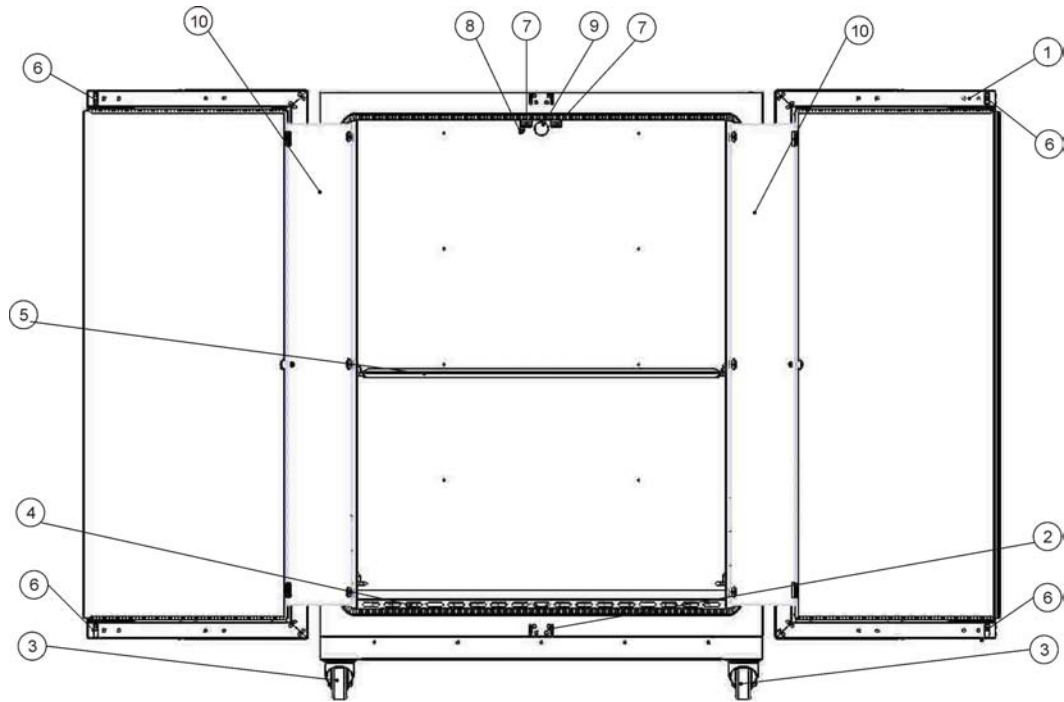

Figure 4-5 Heratherm IGS 750 Front View

- [1] Outer door
- [2] Door hook catch
- [3] Unit caster
- [4] Air baffle
- [5] Perforated shelf
- [6] Door latch
- [7] Glass door latch
- [8] Temperature sensor
- [9] Exhaust air tube
- [10] Glass door

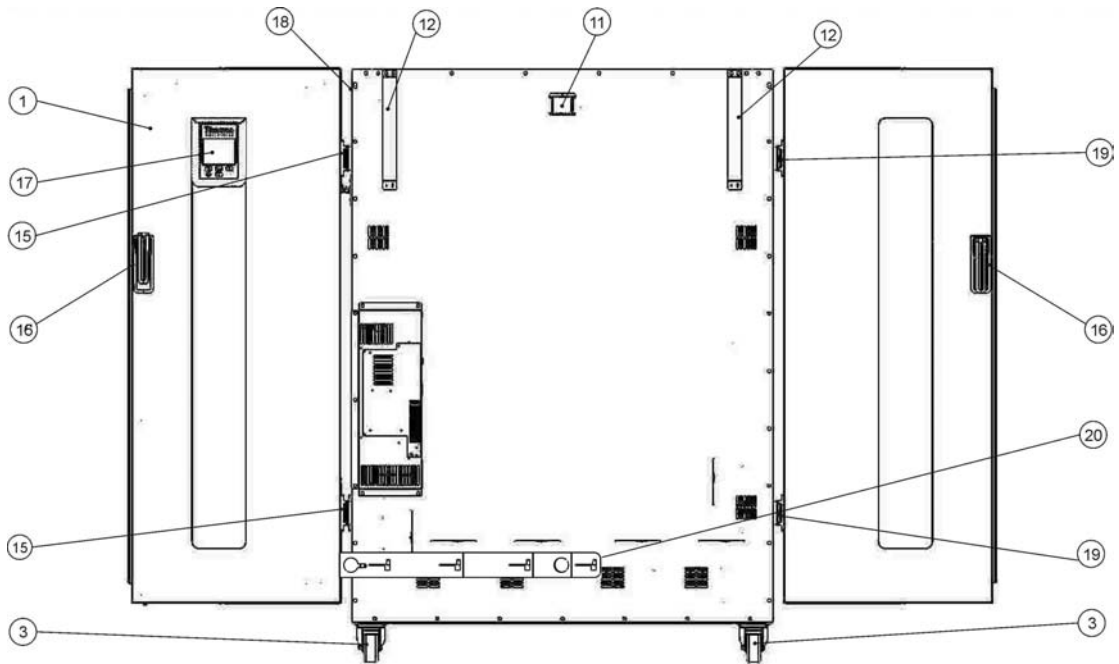

Figure 4-6 Heratherm IGS 750 Rear View

- [1] Outer door
- [2] -
- [3] Unit caster
- [4] -
- [5] -
- [6] -
- [7] -
- [8] -
- [9] -
- [10] -
- [11] Exhaust air tube
- [12] Anti-tilt anchor
- [13] Electronic compartment
- [14] -
- [15] Hinge, right
- [16] Door handle
- [17] Display
- [18] Nameplate on sidewall
- [19] Hinge, left
- [20] Inlet air tube

Safety Devices

The incubators are equipped with the following safety features:

- a sample protection feature that safeguards the samples against destruction through overheating in case of controller failure;
- dual fuses rated at 16 amperes.

Work Space Atmosphere

To ensure undisturbed operation, the ambient temperature in the operating room must be at least 18 °C (64.4 °F).

The heating system uses this temperature threshold to control the ambient temperature plus 5 °C (41 °F) up to the maximum of 75 °C (167 °F).

Sensing and Control System

The PT 100-type sensor for the control of the work space temperature and for the thermal protection [1] is installed on the bottom of table-top units and in the top of floor stand units.

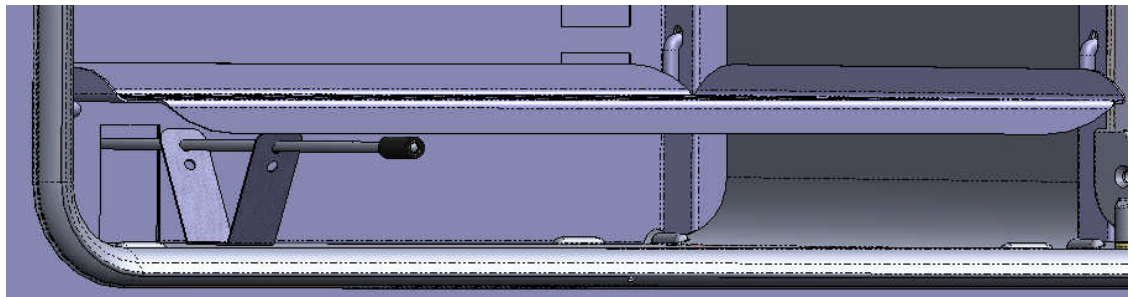

Figure 4-7 Sensor System (for table-top units)

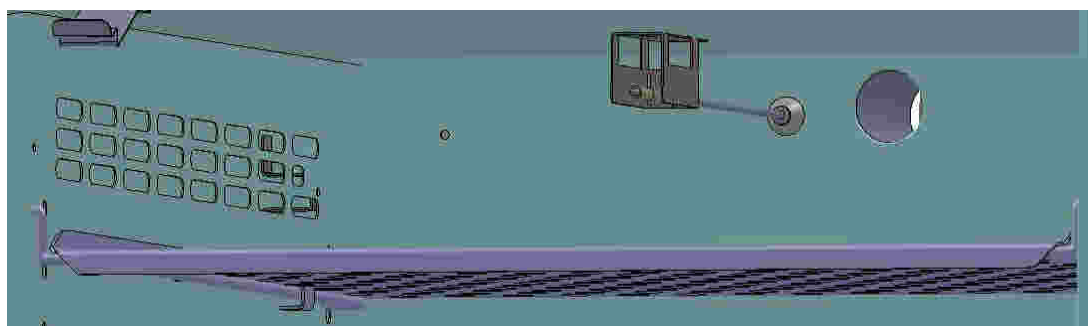

Figure 4-8 Sensor System (for floor stand units)

The work space temperature sensor provides the inputs to the incubator's built-in controller, which continuously compares the measured values to the user-specified set value and adjusts the heaters according to the result.

	<div style="background-color: #0056b3; color: white; padding: 5px; font-weight: bold; font-size: 1.2em; margin-bottom: 5px;">NOTE</div> <p>Do not remove the protective hose from the sensor. Protect the sensor from mechanical damage.</p>
--	---

The unit features a thermal protection function that is factory-preprogrammed and not adjustable. It protects the samples in the work space from overheating: Thermal protection kicks in on a brief violation of the upper limit, based on the defined setpoint temperature, at between 2 and 3 °C (35.6 °F and 37.4 °F) (37 °C (99 °F): 2 °C (35.6 °F), > 50 °C (122 °F): 3 °C (37.4 °F)), automatically reducing the work space temperature to the user-specified set value and allowing the incubation process to be continued even in case of a controller malfunction. If the thermal protection is activated, the error message (E111) “Temperature too high” appears in the display window and an audible alarm is sounded.

When the user acknowledges the error message, the red alarm icon (D3 in [figure 4-1](#) on [page 4-2](#)) is illuminated and the Temperature Set Value icon (see [table 7-3](#) on [page 7-3](#)) is highlighted by a red border to indicate that thermal protection has kicked in.

Data Communications & Alarm Interface

All signal connections are installed in the electrical interface panel at the rear of the incubator.

RS 232 interface

The RS- 232 interface (item 1 in [figure 4-9](#) below) may be used to connect Heratherm incubators to the serial interface port of a computer to allow for the computer-aided acquisition and documentation of major operating parameters (temperature, error codes, etc.).

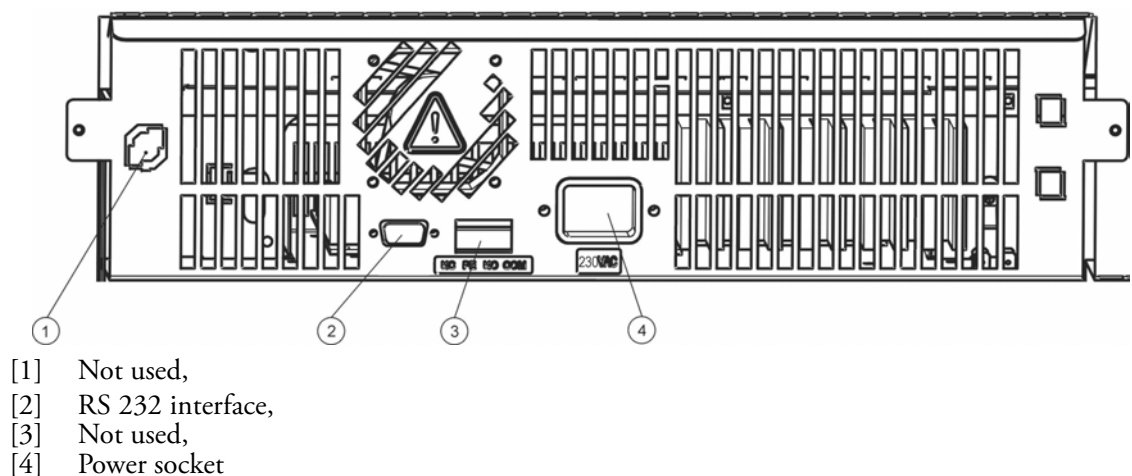

Figure 4-9 Signal Interfaces and Power Socket

	<table border="1"><tr><td>NOTE</td><td>Alarm contact with IGS Series incubators</td></tr><tr><td colspan="2">Although present with IGS Series incubators, the alarm contact is not part of the feature set of Heratherm general protocol microbiological incubators and hence not functional. If you need remote alarming support for your incubator, please contact your local Thermo Fisher Scientific sales representative.</td></tr></table>	NOTE	Alarm contact with IGS Series incubators	Although present with IGS Series incubators, the alarm contact is not part of the feature set of Heratherm general protocol microbiological incubators and hence not functional. If you need remote alarming support for your incubator, please contact your local Thermo Fisher Scientific sales representative.	
NOTE	Alarm contact with IGS Series incubators				
Although present with IGS Series incubators, the alarm contact is not part of the feature set of Heratherm general protocol microbiological incubators and hence not functional. If you need remote alarming support for your incubator, please contact your local Thermo Fisher Scientific sales representative.					

AC Power Socket

The incubator is connected to the AC supply mains via the socket (item 2 in [figure 4-9](#)), which accepts a power cord with an IEC standard plug.

Fuses

Two 16 A slow-blow fuses mounted on the incubator's main electronic circuit board protect internal circuitry from the impact of excessive power consumption.

	<table border="1"><tr><td>NOTE</td><td>Replacement should only be carried out by skilled and authorized qualified personnel of electrotechnology/signal engineering!</td></tr></table>	NOTE	Replacement should only be carried out by skilled and authorized qualified personnel of electrotechnology/signal engineering!
NOTE	Replacement should only be carried out by skilled and authorized qualified personnel of electrotechnology/signal engineering!		

	<table border="1"><tr><td>NOTE</td><td>Fuse replacement</td></tr><tr><td colspan="2">The device fuses are not user-serviceable. When the incubator exhibits the typical signs of a blown fuse (no response to pressing the On/Off button, control panel remains extinguished, no heating operation), call Thermo Fisher Scientific Customer Service to have the fuses replaced.</td></tr></table>	NOTE	Fuse replacement	The device fuses are not user-serviceable. When the incubator exhibits the typical signs of a blown fuse (no response to pressing the On/Off button, control panel remains extinguished, no heating operation), call Thermo Fisher Scientific Customer Service to have the fuses replaced.	
NOTE	Fuse replacement				
The device fuses are not user-serviceable. When the incubator exhibits the typical signs of a blown fuse (no response to pressing the On/Off button, control panel remains extinguished, no heating operation), call Thermo Fisher Scientific Customer Service to have the fuses replaced.					

Work Space Components

Inner Chamber

All components of the work space are made of corrosion-resistant stainless steel and have an absolutely smooth and easy-to-clean surface. Any embossings have a large radius.

Access Port

A re-sealable, capped access port (can be closed off using the plugs delivered with the unit) allows cables, hoses or additional sensor leads to be routed into the work space of the incubator.

The access port [2] has a diameter of 42 mm.

NOTE	Operating conditions
<p>When accessories are to be operated in the work space of the incubator, the ambient condition requirements must be observed (see table below). The energy introduced into the work space has an impact on the lower end of the temperature control range. When additional heating sources are introduced into the work space, temperature control may be adversely affected.</p>	

Shelf System

The incubator is supplied with two perforated shelves. The shelf support rails [1] have an alternating pattern of oblong and round perforations spaced evenly at 30 mm, allowing the shelf support [8] to be inserted without any room for error, yet in a very flexible way to accommodate any required height of sample container. The shelves [2] have an integrated tilt protection and pull-out stop. For details on using the shelf system, see “[Start-up](#)” on [page 5-1](#).

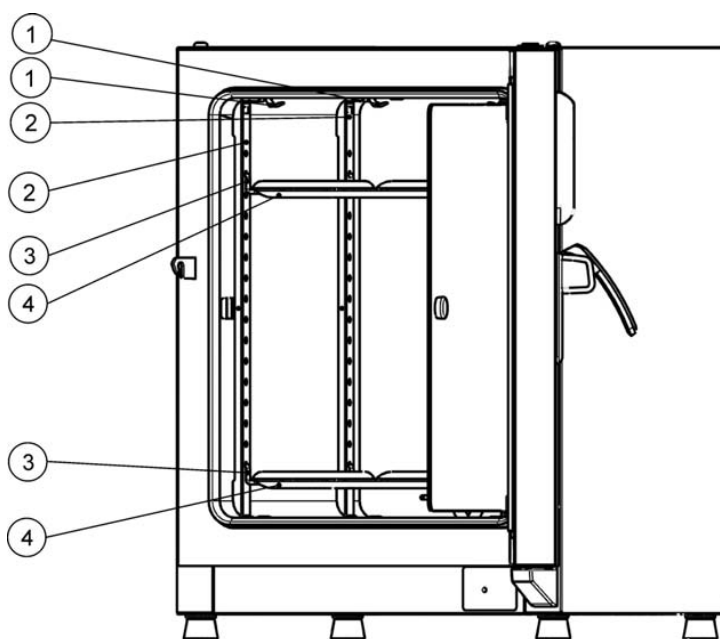

- [1] Retaining Springs
- [2] Support rails
- [3] Shelf support
- [4] Perforated shelves

Figure 4-10 Shelf System

Tube Access Ports

Heratherm incubators may be equipped with additional tube access ports in the side and top panels.

Available tube access port options are listed in [table 4-1](#) below.

Table 4-1 Tube Access Ports for Heratherm Incubators (Option)

Model	Side Panel Mounted Port, dia. in mm/inch	Top Panel Mounted Port, dia. in mm/inch
IGS	24/0.95 or 58/2.28	24/0.95 or 58/2.28

The tube access ports are mounted in fixed locations in the side and top panels (see [figure 4-11](#)).

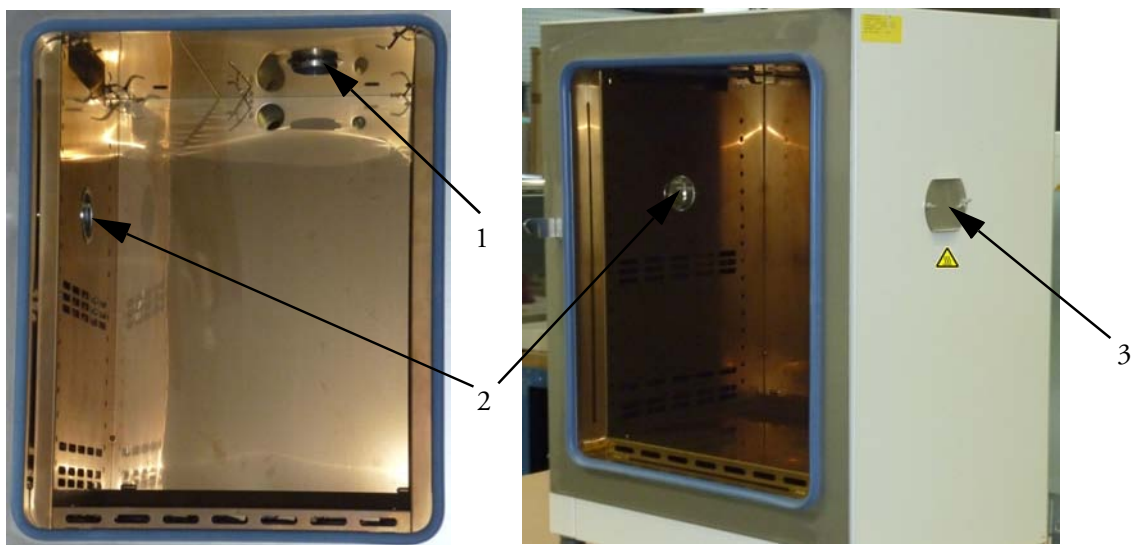



Figure 4-11 Tube Access Ports

- [1] Top panel mounted tube access port
- [2] Side panel mounted tube access port
- [3] Sealing cap for side panel mounted tube access port

Once the cables, tubes or other conduits have been inserted, the tube access ports must be padded with the heat-resistant fiber pads shipped with the device and the cap must be mounted to seal the port as far as possible.

		<p>Risk of Burning on Hot Surface</p> <p>The surface around the tube access ports may become extremely hot.</p>
---	---	---

Start-up

Installing the Shelf System for Table-top units

The installation of the shelf system does not require any tools. The support rails are secured in place by spring action. Once the shelf support have been inserted into the rails, the perforated shelves can be simply pushed onto their support hooks to complete the installation.

NOTE

The support rails of the floor stand units cannot be removed.

Initial installation

1. Peel off the protective foil from the support rails.
2. Push the retaining spring [1] into the guide on the support rail [2], making sure that the locking nub [3] on the retaining spring safely engages with the matching hole in the support rail.

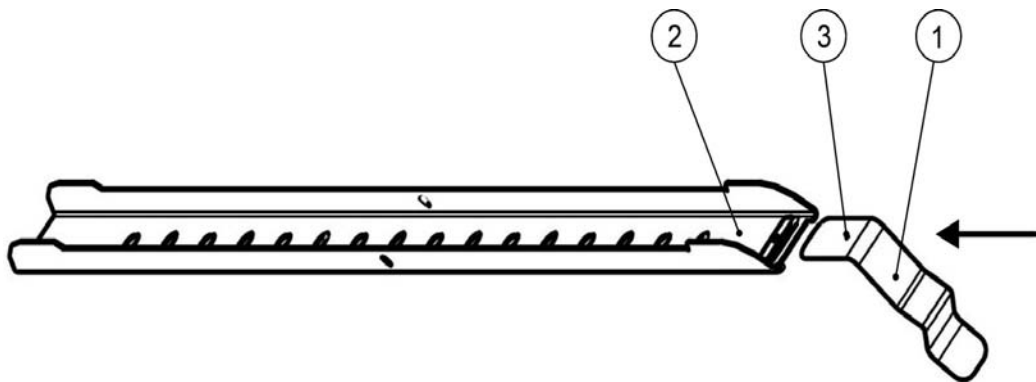
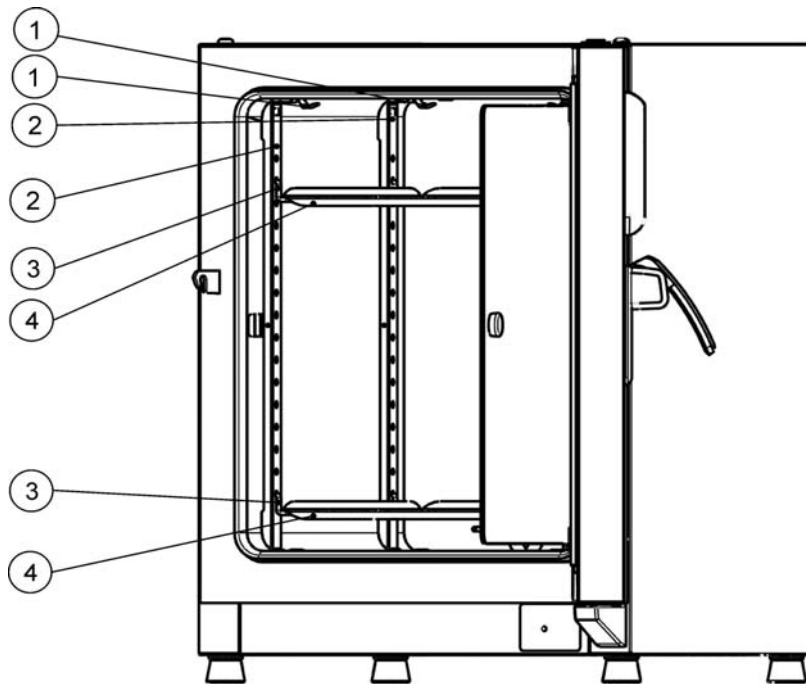

Figure 5-1 Sliding the Retaining Spring into the Support Rail

Installing the Perforated Shelves

The illustrations below show the placement of the shelf system elements.



- [1] Clip spring
- [2] Support rail (for floor stand units, air baffle)
- [3] Shelf support,
- [4] Perforated shelf

Figure 5-2 Installing the Shelving

Preparing the Work Space

Upon delivery, Heratherm incubators are not in a sterile state. Before the initial start-up, the incubator must be decontaminated.

The following work space components should be checked for cleanliness and disinfected prior to use:

- support rails (table-top units),
- shelf support,
- perforated shelves,
- work space surfaces,
- work space seals and gaskets,
- glass door.

NOTE

Cleaning and disinfection

For details about the cleaning and disinfection of the incubator, please refer to “[Cleaning and disinfection](#)” on [page 9-1](#).

Installation of the Support Rails (only for Table-top Units)

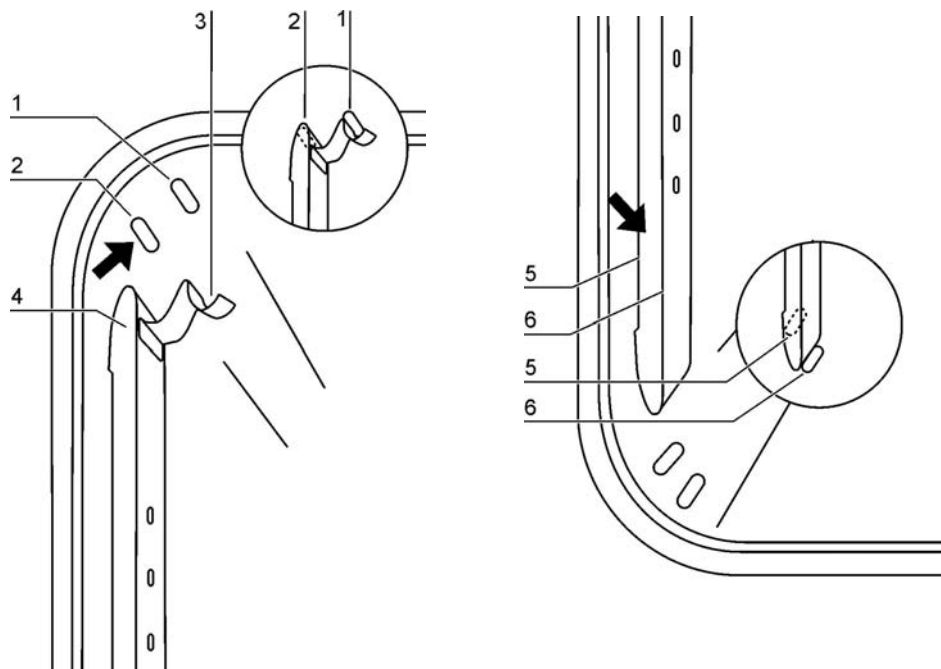

Figure 5-3 Support Rail Installation

The embossings at [2] and [5] act as lateral guides for the support rails, while the embossings at [1] and [6] secure the support rails in place. For the support rails to install correctly the retaining spring [3] must be facing upwards.

1. Place the support rail [4] on the lower embossing [6] and tilt it upwards against the work space side wall so that the rail is positioned over the two embossings at [5] and [2].
2. Clamp the retaining spring [3] behind the upper embossing [1].
3. To remove the support rails, pull the retaining spring tab down out of the embossing and remove the support rail assembly.

Installing the Shelf Support Brackets

1. Insert the shelf support [3] into the perforations [1] of the support rail and tilt it downwards.
2. Make sure that the two vertical elements [2] of the shelf support butt against the support rail.

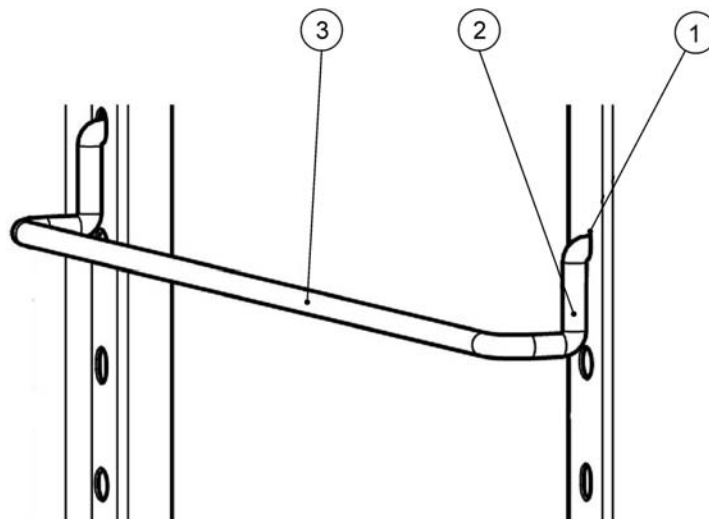
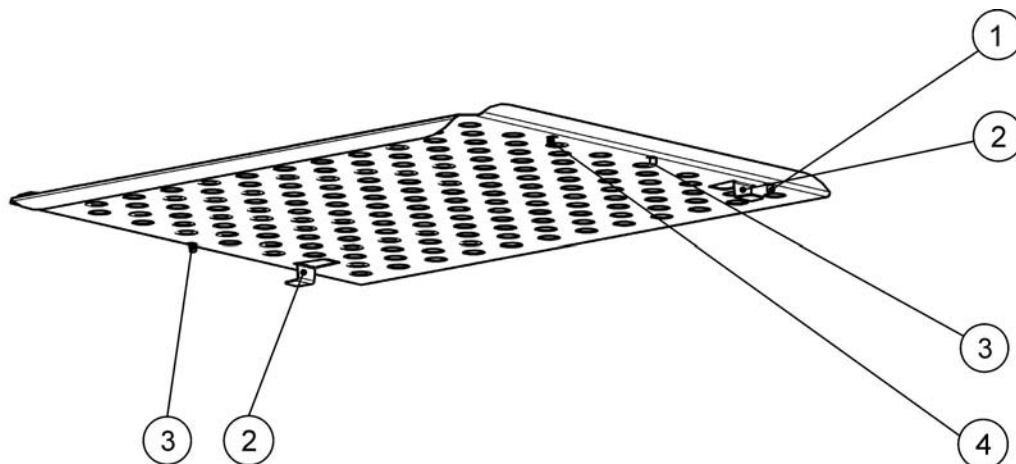

Figure 5-4 Shelf Support Installation

Installing the Perforated Shelves



- [1] Rear Pull-out Stop
- [2] Anti-tilt anchor
- [3] Front Pull-out Stop
- [4] Shelf

Figure 5-5 Installing the Perforated Shelves

1. Push the shelf [4] onto the shelf support with the tilt protection devices [2] facing the rear panel of the incubator.
2. Slightly raise the perforated shelf so that the pull-out stops [1] and [3] can slide over the shelf support.
3. Make sure that the shelves and both of their tilt protection devices are free to move over the shelf support.

Installing/Removing air baffles

The section below describes how to install/remove the bottom plate.

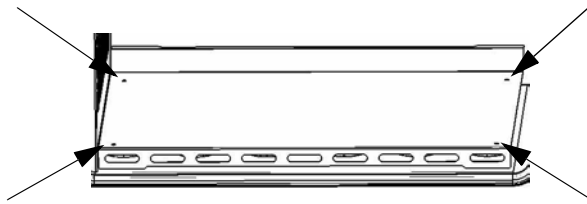

Figure 5-6 Removing the bottom plate

1. Loosen and remove the four (4) screws in the bottom plate and then remove the bottom plate completely.

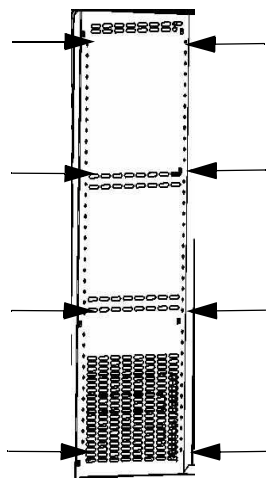

Figure 5-7 Removing the left and right support profiles

Loosen and remove the eight (8) screws for the left and right support profiles and then take out the lateral air baffles.

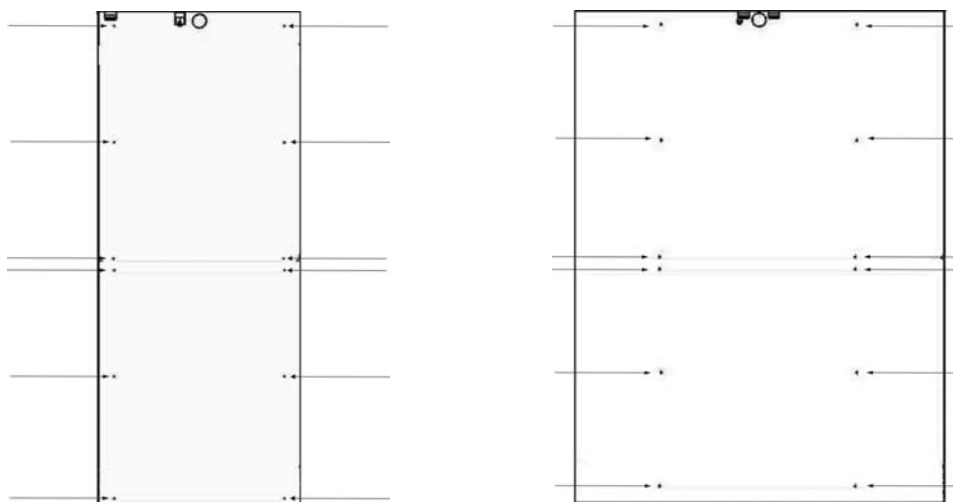



Figure 5-8 Removing the rear air baffle IGS 400 / 750

On the IGS 400 model loosen and remove the six (6) screws for the rear air baffle and for model IGS 750 loosen and remove the six (6) screws for the top and bottom air baffles and then remove the air baffle(s).

Levelling the Table-top Incubator

1. Position a bubble level onto the center shelf.
2. Manually adjust the levelling feet until the shelf is horizontally aligned in all directions. Perform the adjustment of the levelling feet from left to right and from rear to front.

Connecting Power

	 Electric shock Contact with live electrical components may cause a lethal electric shock. Before connecting the incubator to the power supply, check the power cord and the plug for damage. Do not use damaged cables for connecting the incubator to the power supply!
---	---

The incubator has a class I, protection-earthed enclosure. To minimize the risk of electrical shock, use the AC power cord supplied to connect the incubator to a correctly installed and protection-earthed power supply source, with the following features in place for each incubator:

- T 16 A slow-blow fusing
- B 16 circuit breaker

Connection to the Power Supply Source

1. Before connecting the incubator to the power source, check to see if the power supply voltage corresponds with the specifications on the nameplate on the front of the incubator. If the voltage (V) and current (A) ratings given are not as required, do not connect the incubator to the power source!
2. Connect the IEC connector to the socket at the rear of the incubator.
3. Route the power cord along a path that does not cross exhaust air piping or passageways and aisles. With stacked devices, keep the power cord away from hot spots on the other incubator in the stack.
4. Connect the protection-earthed plug of the power cord to a correctly protection-earthed and earth leakage circuit breaker fused power socket.
5. Make sure the power cord is not subjected to tensile or compressive force.

	NOTE	Make sure that power outlets remain freely accessible at all times!
<p>In an emergency the power connection must be rapidly disconnectable; so be sure to have the power outlets freely accessible at all times!</p>		



Figure 5-9 AC Power Supply Socket

Note The alarm contact is not functional with IGS Series incubators. If you have a need for alarming, please contact Thermo Scientific Customer Support for advice.

	NOTE	Condensation
<p>When taking the incubator into operation for the first time allow some time before switching on for stabilization to avoid condensation forming on live parts.</p>		

Connecting the RS-232 Interface

	NOTE	Replacement should only be carried out by skilled and authorized qualified personnel of electrotechnology/signal engineering!
--	-------------	--

The RS-232 data communication interface supports the querying of status information and temperature data from the incubator by entering basic commands in a standard terminal window provided by your computer's operating system. The interconnection requires a standard RS-232 cable with 9-pin connectors and a straight "1:1" pinout without any crossed wires, which is not supplied with the incubator.

Users may employ the RS-232 command inventory listed in [table 5-1](#) below for automating process data logging - for example, by embedding these commands in scripts that run on a remote computer.

		RS-232 interface compatibility To avoid overloading and damaging the RS-232 interface check the interfacing parameters against the pin-out description given above and make sure that computer's interface port works with a signal level of +/- 5V DC.
--	---	---

Interconnecting the Incubator with a Computer

1. Turn the computer off.
2. Route the serial interface cable along a path that does not cross hot exhaust air piping, tables, aisles or passageways. With stacked devices, keep the serial interface cable away from hot spots on the other incubator in the stack.
3. Connect one connector of the serial interface cable (cable length, 5 to max. 10 m, not supplied as a standard item) to the socket labeled RS 223 in the computer and alarm interface section at the rear of the incubator.
4. Connect the second connector to an unused COM 1 /COM 2 or other serial port on the computer.
5. Boot the computer.
6. Launch your standard terminal program and set up the connection with the following parameters:
 - 57600 bits per second
 - 8 Data bits
 - 1 stop bit
 - No Parity
7. Once your terminal indicates that serial communication has been established successfully, enter any of the commands listed in table 5-2 below, depending on what type of information you want to query.
 - Use the following generic command syntax:

?:aaa:bb::cc<CR>, where:
 - **?:** identifies the command line as a query;
 - **aaa:** is the parameter address;
 - **bb::** is a query, that must be left at "00" for technical reasons;
 - **cc** is for a command - specific checksum listed in the table below.
 - **<CR>** is for carriage return.

You will receive a response of the following general format:

?:aaaa:bb:XXXXXX:cc<CR>, where:

- ?: identifies the line as a response to a query;
- aaaa: is the parameter address entered with the query;
- bb: is the number of payload bytes in hexadecimal code - for example, 1F for the decimal value 31;
- XXXXXX: is the significant status information queried;
- cc: is a check sum (technically an inverted XOR of all bytes returned, excluding the check sum bytes and the <CR> character);
- <CR> is for carriage return.

Table 5-1 Terminal Commands for Querying Data

Command Syntax	Response Example
Combined Date and Time	
?:0010:00::c1	!:0010:11: 31.07.10 ;01:02:23:e2 Date Time
Date only	
?:0011:00::c0	!:0011:08: 31.07.10 :d2 Date
Time only	
?:0012:00::c3	!:0012:08: 01:02:23 :dc Time
Temperature Set Value (T1); Current Work Space Temperature (T2); Reference Temperature (T3); Sample Sensor Temperature (T4)	
?:3010:00::c2	!:3010:1f:+125.00;+124.96;+000.000;+000.00:b0 T1 T2 T3 T4

Start-up
Connecting the RS-232 Interface

Operation

Preparing the Incubator

The incubator must not be released for operation before all major start-up activities have been completed (see “Start-up” on page 5-1).

Device Check

Prior to starting operation, the following incubator components must be checked for their correct function:

- The door seal in the front frame must not be damaged.
- The glass door must not be damaged.
- The shelving components must be installed safely.
- Disinfecting the Incubator’s Work Space

Disinfect the work space according to the operator-specified hygiene guidelines.

Starting Operation

1. Turn the incubator on using the control panel.
2. Adjust the temperature set value on the control panel.
3. The temperature controller starts adjusting the work space to the user-specified temperature set value now.



To avoid any risk of explosion or fire

- refrain from loading the incubator with any of the substances listed in the section “Incorrect Use” on page 1-5
- make sure that the ambient air is free of any solvents
- do not operate the incubator in areas with an explosion hazard

4. Load the work space with samples.



 **WARNING**

Hot surfaces

The screen of the glass door, the interior panel of the outer door as well as the surfaces of the shelving and the work space become hot while the incubator is running through its heating cycles and need some time to cool down.

When removing samples from a running or recently completed heating cycle, always wear safety gloves and other appropriate personal protection equipment to avoid burns on hot surfaces!

 **CAUTION**

Risk of overloading

Overloading may damage the shelves or cause the shelves and/or the incubator to tilt when the shelves are being drawn out, ultimately destroying the samples. To avoid overloading the incubator or its shelving be sure to observe the sample weight limits specified in “[Technical Data](#)” on [page 13-1](#).

NOTE

Proper loading

To ensure sufficient air circulation and uniform heating of the samples, do not use more than 70% of the maximum surface area of the work space. Bulky objects in the work space that dissipate heat may impair heat distribution.

Handling and Control

Heratherm IGS Series incubators come with a front panel mounted control unit consisting of a multifunctional display, four control buttons, and an on/off button. The four control buttons interact with the display window to let users access all of the user control functions and adjustments of the incubator, including - for example, the temperature set value, timer, energizing/de-energizing the AC outlet in the work space, as well as a variety of other functions.

Under normal operating conditions the display presents user with the work space temperature. The display returns to its default mode upon completion of the adjustments or whenever no entries have been made for a period of 30 seconds.



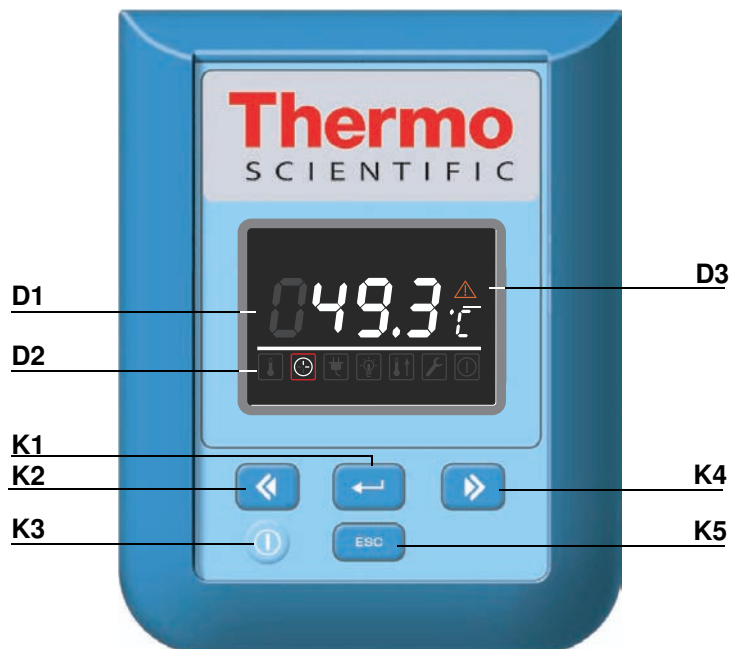

The graphic below shows the Heratherm IGS 60/100/180/400/750 control panel with all of its visualization elements and controls.

Figure 7-1 Control Panel for Heratherm IGS Series Incubators







The table below contains brief descriptions of the buttons on the control panel (items K1 through K5 in [figure 7-1](#)).

Table 7-1 Control Buttons

Icon	Item	Function
	K1	<p>Menu/Enter button</p> <p>First key press: Activates the menu, highlighting the first menu item with a red border.</p> <p>Second key press: Selects the currently activated menu item (as highlighted by the red border), At the same time, pressing this button enables entries with item D1.</p> <p>Third key press (once a setting has been changed): Confirms a previous entry or selection.</p>
	K2	<p>Left button</p> <p>After the first press of Menu/Enter button:</p> <ul style="list-style-type: none"> - Moves the selection in the menu (see item D2) to the next icon on the left. <p>Once a menu item has been selected:</p> <ul style="list-style-type: none"> - Decreases an adjustable parameter value - for example, the temperature set value in D1. Holding this button depressed for a few seconds changes the selected value in quick run mode. - Moves the selection in the display field D1 in the currently activated menu item to the next option on the left - for example, from the Off state of the timer to On.
	K3	<p>On/Off Button</p> <p>Holding this button depressed for 2 seconds switches the incubator off. The display window goes out, except for the readiness indicator icon in the status display area at item D2.</p> <p>The temperature display pane D1 provides as dimmed readout of the work space temperature, provided that the temperature exceeds 50 °C (122 °F).</p>
	K4	<p>Right button</p> <p>After the first press of Menu/Enter button:</p> <ul style="list-style-type: none"> - Moves the selection in the menu (see item D2) to the next icon on the right. <p>Once a menu item has been selected:</p> <ul style="list-style-type: none"> - Increases an adjustable parameter value - for example, the temperature set value in D1. Holding this button depressed for a few seconds changes the selected value in quick run mode. - Moves the selection in the display pane in D1 in the currently activated menu item to the next option on the right - for example, from the On state of the timer to Off.
	K5	<p>Escape button</p> <p>Returns to the previous level of the menu or standard display. Upon exiting from the current menu item the user may be prompted to save any previously made settings.</p>

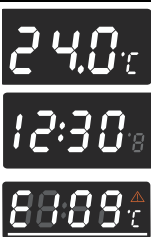
The table below contains brief descriptions of the display features of the control panel (items D1 through D3 in [figure 7-1](#); the identifiers K1 through K4 refer to the buttons shown in that figure).

Table 7-2 Display Features

Feature	Item	Function
	D1	<p>Display pane showing a permanent readout of the actual temperature in the work space either in °C or °F (depending on the user's preferences, see "Toggling the Temperature Display Unit" on page 7-12). At temperatures below 105 °C or 221 °F the temperature readout has one digit after the decimal point, while temperatures beyond are shown without any decimal places.</p> <p>A flashing time entry prompt of the general format hh:mm (hours:minutes, both with two digits) appears in this place while the user is setting up a timer.</p> <p>Upon occurrence of an error condition, the current error code flashes in this area. Additionally, the red alarm icon at D3 flashes.</p>
	D2	<p>Menu bar with iconized representations of adjustable parameters. A red border is used to highlight the current Menü item, as selected using the Menu (K1) and arrow buttons Left (K2) and Right (K4). Brief descriptions of the individual menu items are given in table 7-3.</p> <p>Note If a menu item cannot be selected, then the function it represents is not part of the equipment configuration of your unit.</p>
	D3	<p>Alarm icon: Upon occurrence of an error condition, the red alarm icon will be illuminated. At the same time the current error code will flash in the display pane D1. The alarm may be acknowledged by pressing the button. </p>

The table below contains brief descriptions of the menu bar icons (item D2 in [figure 7-1](#))

Table 7-3 Menu Bar Icons





Icon	Function
	<p>Temperature Set Value</p> <p>Allows for changing the temperature set value (factory-preset to 37 °C/99 °F) within the permissible temperature range. The set value can be changed by pressing the Left and Right (item K2 or K4) and you can, after confirming your changes with the Menu/Enter button (item K1), track the impact on the actual temperature in the display field at D1.</p> <p>Instructions: "Temperature Set Value" on page 7-6.</p>
	<p>Timer</p> <p>Allows for having the incubator turn on and/or off upon expiry of a user-specified countdown period. When the user enables an "on timer" the display goes out. A rotating arrow in the Timer icon and the illuminated readiness indicator icon in the status display area indicate that the timer is running.</p> <p>Instructions: "Timer" on page 7-7.</p>

Table 7-3 Menu Bar Icons

Icon	Function
	<p>Settings</p> <p>Invokes a submenu with the following functions:</p> <ul style="list-style-type: none"> - Read access to error log - Calibrating the incubator - Toggling the temperature display unit between °C and °F - Entering a configuration control code <p>(Instructions: “Settings” on page 7-10)</p>
	<p>Readiness Indicator</p> <p>Illuminated when the incubator has been switched off using the On/Off button (item K3 in figure 7-1). Unlike other menu items, this icon cannot be selected.</p> <p>(Instructions: “Switching the Incubator Off / Powering Down” on page 7-5)</p>

Powering Up

1. Plug the power plug of the incubator into a suitable protection-earthed AC power outlet.



In the display window on the front panel the readiness indicator icon (top right item at D3 in [figure 7-1](#) on [page 7-1](#)) is illuminated.



2. Keep the **On/Off** button depressed for two seconds.

An initialization routine will be run after the incubator has been powered up. Once initialization has been completed, the display will light up and the current work space temperature will appear in the temperature display pane (item D1 in [figure 7-1](#) on [page 7-1](#)). The incubator is ready for use now.

Switching the Incubator Off / Powering Down



1. Keep the **On/Off** button depressed for two seconds.



The display window goes out, except for the readiness indicator icon (right most icon in the top right item at D3 in [figure 7-1](#) on [page 7-1](#)) and a residual heat temperature readout in case the work space temperature is still ≥ 50 °C/122 °F. The incubator is switched off now.



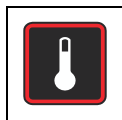



2. If required, unplug the AC power plug to power down the incubator completely.



Temperature Set Value

Heratherm incubators allow for setting the desired work space temperature directly using only a few button presses. After confirming the new temperature set value, you may trace the resulting temperature change in the temperature display pane (item D1 in [figure 7-1](#) on [page 7-1](#)).

Table 7-4 Adjusting the Temperature Set Value

	<p>Press  to activate the menu bar, then use  to select the Temperature icon and press  to confirm.</p>
	<p>In the temperature display pane, press  or  to adjust a new temperature set value, then press  to confirm your settings.</p>
	<p>The display returns to its default mode. The actual temperature measured in the work space and shown in the temperature display area starts to change until it reaches the newly adjusted set value.</p>



Timer

The **Timer** feature from the menu bar enables the user to set a “countdown-type” on or off timer that switches the incubator on or off after a preset period of time. Instructions for setting an off timer are given in [table 7-5](#) (see below), while its use as an on timer is described in [table 7-6 on page 7-7](#).

Programming a turn-on time causes the incubator to switch off until it is scheduled to restart, while a turn-off time keeps the device running before it shuts down at the user-specified time. The timer starts running immediately as soon as the user confirms his or her entries.



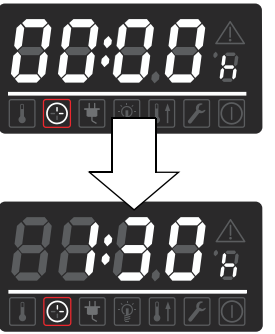





Table 7-5 Setting a Countdown-type Off Timer

	<p>Press to activate the menu bar, then use to select the Timer icon and press to confirm.</p>
	<p>The word OFF appears in the multifunctional display pane. Choose the off timer with .</p>
	<p>Set the hours and minutes until the incubator is supposed to shut down by pressing or , then press to confirm.</p>
	<p>The display returns to its default mode. In the menu bar, the Timer icon is illuminated and an arrow is rotating on the icon's face.</p>

Table 7-6 Setting a Countdown-type On Timer

	<p>Press to activate the menu bar, then use to select the Timer icon and press to confirm.</p>
	<p>The word OFF appears in the multifunctional display pane.</p>

Table 7-6 Setting a Countdown-type On Timer

	<p>Press  to select the On timer option and confirm the selection with .</p>
	<p>Set the hours and minutes until the incubator is supposed to turn on by pressing  or , then press  to confirm.</p>
 	<p>The incubator switches off. The display goes out, the Timer icon is illuminated in the menu bar with a hand rotating on its face. Additionally, the readiness indicator icon is illuminated.</p>

Stopping a timer

Table 7-7 Stopping an Off Timer Before It Expires











	<p>Press  to activate the menu bar, then use  to select the Timer icon and press  to confirm.</p>
	<p>Confirm the OFF by pressing , then press  to return to the main menu.</p>
	<p>In the menu bar, the Timer icon will go out.</p>

Table 7-8 Stopping an On Timer Before It Expires

	<p>To cancel a pre-programmed on timer while the incubator is switched off, hold the On/Off button depressed for a few seconds.</p>
	<p>In the menu bar, the Timer icon will go out.</p>

NOTE

Stopping a Timer

When you cancel a programmed timer you do not return to the main menu but rather to the appropriate level required for the timer restart.



Settings

The **Settings** menu item opens a submenu populated with various commands for viewing general status information on the Heratherm unit and setting for the operation of the incubator or its display window:

- Read access to error log
- Calibrating the incubator
- Toggling the temperature display unit between °C and °F
- Entering a configuration control code

Instructions for using these features are given in the following.

Error Log

Users calling customer service for support may be asked by the Thermo Fisher Scientific agent to supply information from the error log of the incubator.





It enables the user to browse through the most recent 22 alarm messages that were caused by hardware or control loop errors. Each error is displayed with an internal error code.

Error codes and instructions for clearing alarm conditions appear in the section [“Error Codes”](#) on [page 12-1](#).

Table 7-9 Reading the Error Log

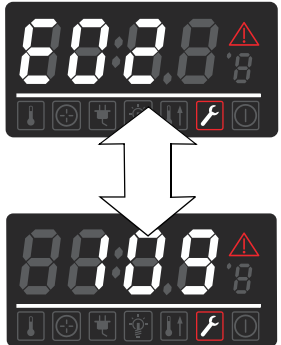
	<p>Press to activate the menu bar, then use or to select the Settings icon and press to confirm.</p>
	<p>The word Err appears in the display pane to indicate that the error log has been selected.</p>
	<p>Use the button to select the first entry in the error log, numbered E01 (Error 01). After a few seconds, the display pane automatically switches to the internal error code - for example, 109. E01 shows the latest fault, E22 shows the oldest fault.</p>

Table 7-9 Reading the Error Log

	<p>Press  to go to the next entry (or  to go back to the previous one). After reaching the entry numbered 22 the display wraps and returns to the beginning of the error log, that is, to entry “number E01.</p>
	<p>To exit from the error log and return to normal display mode press  . The Settings icon in the menu bar will go out.</p>

Calibration

The **Settings** -> **Calibration** menu item enables the user to initiate a temperature calibration routine for the built-in temperature sensors and choose whether calibration should be accomplished manually or automatically:

- The **Manual** option allows for entering an absolute temperature directly, as measured - for example, using an external reference sensor.

	<div style="border: 1px solid black; padding: 5px;"> <p style="text-align: center;">NOTE</p> <p>Calibration Prerequisites</p> <p>Maintain the ambient conditions within the specified limits of the incubator before launching calibration.</p> <p>Varying ambient conditions may impact the result of the calibration routine, which may lead to misadjustment of the controller and unreliable temperature control operation.</p> </div>
--	--

Table 7-10 Entering the Calibration Reference Temperature Manually















	<p>Prepare for temperature calibration (see “Preparing Temperature Calibration” and “Comparison Measurement Procedure” on page 10-3).</p>
	<p>Press  to activate the menu bar, then use  or  to select the Settings icon and press  to confirm.</p>

Table 7-10 Entering the Calibration Reference Temperature Manually

	<p>Press  to switch to the CAL(ibration) menu item and press  to confirm.</p>
	<p>The word USEr appears in the display pane. Press  to confirm the selection.</p>
	<p>In the settings dialog that appears, set the temperature measured with the external reference sensor by using  or  and confirm the settings with .</p>
	<p>The newly entered value will be stored and used to calibrate the internal temperature sensors with the value measured by the reference sensor. The display returns to its default mode. The Settings icon in the menu bar will go out.</p>

Temperature Display Unit

The **Settings** -> °C / °F menu item allows for toggling the incubator used for displaying temperatures between degrees Centigrade and Fahrenheit.

Table 7-11 Toggling the Temperature Display Unit











	<p>Press  to activate the menu bar, then use  or  to select the Settings icon and press  to confirm.</p>
	<p>Press  to switch to the C - F menu item. The text C - F is flashing in the display pane.</p>

Table 7-11 Toggling the Temperature Display Unit

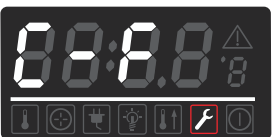
	<p>Press the  button.</p> <p>The currently unused temperature unit °C or °F is flashing in the display pane (factory setting is °C).</p> <p>Confirm the selection with .</p>
	<p>The temperature unit to the right of the temperature display field (item D1 in figure 7-1 on page 7-1) has changed according to your selection.</p> <p>The display returns to its default mode.</p> <p>The Settings icon in the menu bar will go out.</p>

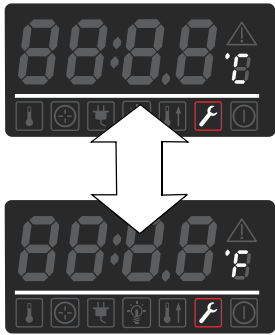
Handling and Control
Switching the Incubator Off / Powering Down

Shut-down

Shutting the Incubator Down

This chapter provides instructions for shutting the incubator down for prolonged periods of time, that is, at least for several days in a row.



	<div style="border: 1px solid black; padding: 5px;"> WARNING Contamination hazard</div> <p>If the work space surfaces are contaminated, harmful biological material may spread to the environment of the incubator.</p> <p>To rule out any risk for subsequent users, perform a full cleaning, disinfection and decontamination cycle to the standards set out in the section “Cleaning and disinfection” on page 9-1 if you suspect (or if you are positive) that harmful biological material has been processed with the incubator.</p>
--	---

1. Remove the containers with the cultures, all accessories, and other objects from the work space.
2. Clean and disinfect the work space, as explained in the section “[Cleaning and disinfection](#)” on [page 9-1](#).
3. When cleaning and disinfection and/or decontamination are done, turn the incubator off using the control panel.
4. Unplug the power cord and secure it against accidental reconnection.
5. Until the incubator is shut down, the work space must be continuously ventilated. Leave the door open and secure it against accidental closure.

**Shut-down
Shutting the Incubator Down**

Cleaning and disinfection

Cleaning

		Incompatible cleaners
	<p>Some incubator components are made of plastics. Solvents may attack plastics. Strong acids or alkaline solutions may cause embrittlement of plastics.</p>	
		Moisture-sensitive components
	<p>Do not spray cleaning agent onto the control panel and the control box at the rear of the incubator. When wiping the incubator clean, always make sure that no moisture enters into these components.</p>	
	<p>Wipe the display window down with a slightly dampened cloth, then wipe dry with a rag made of 100% microfiber.</p>	

Cleaning Exterior Surfaces

Remove dirt residues and depositions thoroughly using a solution of lukewarm water and commercial detergent.





Wipe the surfaces clean using a clean cloth and clear water.

Then, wipe the surfaces dry using a clean cloth.





Wipe / spray disinfection

The manual wipe and spray disinfection is a three-stage process:

- predisinfection
- cleaning
- final disinfection

		Alcoholic disinfectants!
		<p>Disinfectants having an alcohol content of more than 10% may form, in combination with air, easily combustible and explosive gas mixtures.</p>
		<p>When using such disinfectants, avoid open flames or exposure to excessive heat during the entire disinfection process!</p>
		<p>Use such disinfectants only in adequately ventilated rooms.</p>
		<p>After the disinfectant has been allowed to react, wipe the cleaned incubator components thoroughly dry.</p>
		<p>Observe safety regulations to avoid fire and/or explosion hazard caused by alcohol-containing disinfectants.</p>
		Chloride-containing disinfectants!
		<p>Chloride-containing disinfectants can corrode stainless steel.</p>
		<p>Use only disinfectants that do not affect stainless steel!</p>

Preparing the manual wipe/spray disinfection

		Health hazard
		<p>The surfaces of the work space may be contaminated. Contact with contaminated cleaning liquids may cause infections. Disinfectants may contain harmful substances.</p>
		<p>When cleaning and disinfecting, always observe the safety instructions and hygiene guidelines!</p>
		<p>Wear safety gloves.</p>
		<p>Wear safety goggles.</p>
		<p>Wear mouth and respiratory system protection gear to protect your mucous membranes.</p>
		<p>Observe the safety instructions of the disinfectant's manufacturer and the hygiene supervisor.</p>

Predisinfection

1. Remove all samples from the work space and store them in a safe place.
2. Spray disinfectant onto the surfaces of the work space and of the accessories or wipe the surfaces clean using disinfectant.

		<p>Risk of injury caused by breaking of glass panel</p> <p>The glass panel may only be removed by properly trained and authorized specialists. The glass panel must be held by two persons.</p>
--	---	---

3. Allow time for the disinfectant to act as specified by the manufacturer.

		<p>Disinfecting hard-to-reach components</p> <p>Spray the sensor and other hard-to-reach components with disinfectant!</p>
--	---	--

Cleaning

1. Remove all internals from the specimen chamber.
2. Wipe off the specimen chamber surfaces and the internals that have been removed from the chamber using lukewarm water mixed with standard rinsing agents. Completely remove any tenacious impurities using rinsing agent and warm water.
3. Re-rinse the cleansed surfaces 3 to 5 times with autoclaved water to completely remove and cleaning agent residues.
4. After this, wipe the cleansed surfaces and internals dry with a soft, sterile cloth.

Final Disinfection

1. Spray the specimen chamber surfaces and the internals removed from this chamber again with disinfectant, or wipe them down.
2. Let the disinfectant work on the surfaces/internals as detailed in the manufacturer's instructions.
3. Re-install the internals in the specimen chamber.



Bio-hazard!

Be sure to determine the current operating condition of the incubator before you open the door!

Under specific circumstances, there is a risk that bacteria, viruses, fungi, prions, and other biological substances survive.

Decontamination must be performed immediately if any biohazardous material is spilled in or on the incubator.

Maintenance

Maintenance and inspection at regular intervals of the features and components listed below are mission-critical to maintain the product in a fully operative and safe condition and avoid malfunctions due to ageing and wear. Failure to perform maintenance on a regular basis may result in:

- deviations in heating performance
- loss of control over temperature distribution throughout the work space
- damage to samples

Inspections and Checks

To ensure the operational performance and safety of the incubator and its functions, the components listed below must be checked at regular intervals.

Regular Checks

- Check the incubator for overall cleanliness and remove any residues from previous processes.

Semi-annual Inspection

- Check integrity and proper seating of the door seal.
- Perform functional check of the control panel and of the incubator's built-in controller.
- Perform electrical safety check in accordance with the relevant national regulations.
- Check the locking screw for the glass panel

	<div data-bbox="539 1621 903 1718" style="background-color: #0070C0; color: white; padding: 5px; text-align: center;">NOTE</div> <div data-bbox="927 1641 1174 1675">Functional Check</div> <p data-bbox="523 1733 1417 1832">If safety devices were removed or disabled for inspections, the incubator must not be operated before the safety devices have been reinstalled and checked for their correct function.</p>
--	--

	<div style="border: 1px solid black; padding: 5px;"> WARNING</div> <p>Spare Parts and User Modifications</p> <p>To avoid major malfunctions of the incubator and associated safety hazards that may result in death, serious injuries, or damage to the incubator and other equipment, use spare parts approved by Thermo Scientific only. Third-party spares without approval void the limited warranty.</p> <p>Do not modify the incubator in any way without obtaining the prior written authorization from Thermo Scientific. Unauthorized modifications may compromise operational safety and give rise to hazards that may result in death, serious injuries, or damage to the incubator and other equipment.</p>
--	--

Service Intervals

During ongoing operation, the following service work must be performed:

3-monthly service

Perform the comparative temperature measurement outlined in the following section.

Annual service

Have the incubator inspected and serviced by an authorized Technical Service agent.

	<div style="border: 1px solid black; padding: 5px;"><div style="background-color: #0070C0; color: white; padding: 5px; display: inline-block;">NOTE</div> Service contract</div> <p>Thermo Electron LED GmbH offer a product-specific service contract comprising all necessary tests and service work.</p>
--	---

Preparing Temperature Calibration

To determine the exact measured value of the incubator's integral temperature sensor, a temperature comparison measurement must be performed every three months. If a major temperature deviation is found during this check, temperature calibration is required. During this process, the temperature controller of the incubator is set to the value measured during the temperature comparison measurement.

Use a calibrated measuring instrument with an accuracy of $< \pm 0.1$ °C (0.18 °F) for this test.

To minimize temperature variations during the measurement, put the measuring sensor in an isothermal container (such as a bowl filled with glycerol) before placing it in the work space. Use the center of the work space as the reference location for the comparison measurement.

	<table border="0"><tr><td data-bbox="533 365 895 456">NOTE</td><td data-bbox="922 387 1219 416">Isothermal Container</td></tr><tr><td colspan="2" data-bbox="518 479 1430 544">Do not use a container filled with water as an isothermal container because the evaporation of water will result in a lower temperature reading.</td></tr><tr><td data-bbox="533 591 895 683">NOTE</td><td data-bbox="922 613 1426 642">Excessive Work Space Temperatures</td></tr><tr><td colspan="2" data-bbox="518 705 1406 770">Excessive work space temperatures subsequent to a calibration run can be reduced by leaving the door open for approx. 30 seconds.</td></tr></table>	NOTE	Isothermal Container	Do not use a container filled with water as an isothermal container because the evaporation of water will result in a lower temperature reading.		NOTE	Excessive Work Space Temperatures	Excessive work space temperatures subsequent to a calibration run can be reduced by leaving the door open for approx. 30 seconds.	
NOTE	Isothermal Container								
Do not use a container filled with water as an isothermal container because the evaporation of water will result in a lower temperature reading.									
NOTE	Excessive Work Space Temperatures								
Excessive work space temperatures subsequent to a calibration run can be reduced by leaving the door open for approx. 30 seconds.									

Comparison Measurement Procedure

1. Turn the incubator on using the power switch.
2. Set the temperature set value and allow the incubator to stabilize. This may take several hours.
3. Place the measuring device in the center area of the work space. Alternatively, a temperature sensor may be positioned in this location. Route the connecting cable between the glass panel and the interior tank.
4. Close the doors.
5. Wait until the temperature value displayed on the measuring instrument has stabilized.
6. Use the temperature reading from the measuring device to calibrate temperature control manually, as explained [“Entering the Calibration Reference Temperature Manually”](#) on [page 7-11](#).

Temperature Calibration Procedure

For detailed instructions on how to perform a manual temperature calibration, please refer to the instructions in the section [“Calibration”](#) on [page 7-11](#).

	<table border="0"><tr><td data-bbox="533 1610 895 1702">NOTE</td><td data-bbox="922 1632 1426 1662">Excessive Work Space Temperatures</td></tr><tr><td colspan="2" data-bbox="518 1724 1406 1789">Excessive work space temperatures subsequent to a calibration run can be reduced by leaving the door open for approx. 30 seconds.</td></tr></table>	NOTE	Excessive Work Space Temperatures	Excessive work space temperatures subsequent to a calibration run can be reduced by leaving the door open for approx. 30 seconds.	
NOTE	Excessive Work Space Temperatures				
Excessive work space temperatures subsequent to a calibration run can be reduced by leaving the door open for approx. 30 seconds.					

Replacing the Door Seal

The door seal of the outer door is located in the retaining slot.

The door seal should be inspected for any signs of embrittlement at half-yearly intervals.

No tools are required to replace the seal.

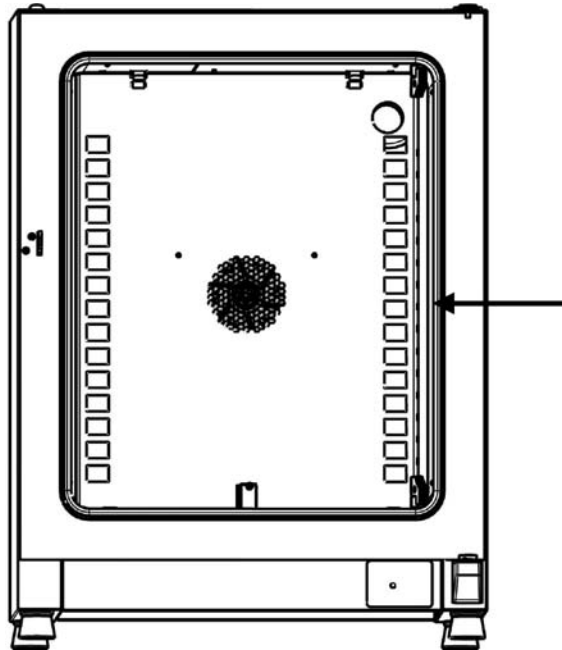

Figure 10-1 Door Seal Replacement

1. Pull the seal out of the guide slot.
2. Starting on the hinge side of the door, position the end of the new seal at the location indicated by the arrow in [figure 10-1](#) above.
3. Gently press the seal into the slot, working around the circumference of the door. In corner areas in particular ensure that the seal lip is installed without any wrinkles and that the seal is not stretched or compressed.
4. Make sure that the retaining rail taper is positioned correctly in the slot and that the seal is flush with the door frame.

Replacing the Power Cord

When the device's power cord is damaged, it must be replaced with an original spare part. Using a standard power cord with a lower temperature withstand class is prohibited.

Returns for Repair

Prior to returning any materials, please contact our Customer Service Department for a “Return Materials Authorization” number (RMA).

Material returned without an RMA number will be refused.

	<div data-bbox="534 477 898 571"> WARNING</div> <p data-bbox="927 495 1238 528">Contamination hazard</p> <p data-bbox="518 589 1406 689">The incubator may have been used for treating and processing infectious substances, which may have caused contamination of the incubator and its components.</p> <p data-bbox="518 692 1390 759">Prior to return shipment, it is therefore mandatory that all incubator components be properly decontaminated.</p> <ul data-bbox="539 784 1426 943" style="list-style-type: none">• Clean the incubator components thoroughly, then disinfect or decontaminate them (depending on application).• Fill in and attach a safety declaration with details on decontamination activities performed to the items that are to be repaired.
--	--

**Maintenance
Returns for Repair**

Disposal

	<div style="border: 1px solid black; padding: 5px;">  <b style="font-size: 1.2em;">WARNING </div> <p>Contamination hazard</p> <p>The incubator may have been used for treating and processing infectious substances, which may have caused contamination of the incubator and its components. Prior to disposal, it is therefore mandatory that all incubator components be properly decontaminated.</p> <ul style="list-style-type: none"> • Clean the incubator components thoroughly, then disinfect or decontaminate them (depending on application). • Attach a declaration of decontamination with details on decontamination activities performed to the items that are to be disposed of.
--	---

Overview of materials used

Component	Material
Thermal insulation components	Glass wool
Printed circuit boards	Coated electrical components contain various plastics materials. Components mounted on circuit boards containing epoxy resin bonder.
Plastic components, general	see material labelling
Exterior housing	Galvanized steel sheet, painted
Incubator rear panel	Galvanized steel sheet
Outer door	Galvanized steel sheet, painted, + stainless steel (optional)
Door inner panel	Stainless steel 1.4301
Control panel and display window protective foil	Polyethylene
Heater	IMH-S: Silicone-sheathed resistance heater wires

Disposal
Overview of materials used

Component	Material
Interior containers, installed components and shelves	Stainless steel 1.4016 + 1.4301
Door frame seal	Silicone
Glass screen	Sodium silicate glass
Cables	Plastic-sheathed stranded copper wire
Packaging	Corrugated board, polyethylene film, and styrofoam, chemically untreated wood

Error Codes

Table 12-1 below lists the error messages that may appear in the control panel display window (see “Error Log” on page 7-10) and provides instructions for clearing such alarms.

Table 12-1 Heratherm Incubator Error Codes



Error Message & Code	Root Cause	Alarm Response	Alarm Clearing Instructions *
Display Error (E002)	Display communication error. The built-in controller was unable to restore communication with the control panel.	Audible alarm activated, message shown on display. Reset after 30 s.	Power cycle the device by unplugging, then reconnecting the power cord. If this doesn't solve the problem, call service.
Mirrored Parameter Loaded (E003)	The controller was unable to read the user-specific settings and had to resort to an emergency parameter set held in mirrored storage.	Text message on display Fallback to mirrored parameter storage. Device continues to run without loss of functionality, including user-specific settings.	Check the latest settings, for example the set value.
Factory Parameter Loaded (E004)	The controller was unable to read the mirrored parameter set and had to resort to factory-preset parameters.	Audible alarm activated, message shown on display. Fallback to factory-preset parameters. User-specific settings may be lost - for example, the temperature display unit preference, or user programs.	Acknowledge by pressing  . Re-enter customer-specific settings.
Default Parameter Loaded (E005)	The controller was unable to read the factory-preset parameters and had to resort to default settings	Fallback to default parameters. Audible alarm activated, message shown on display. The device is completely inoperative.	Call service.
Power Down Error (E007)	Power has been cut off (power outage) while the device was running.	Audible alarm activated, message shown on display.	Check the power supply. Power up then device, then acknowledge the alarm by pressing  .
Config Error (E012)	General device configuration error.	Audible alarm activated, message shown on display.	Call service.
OTP Error (E013)	Klixon contact not closed.	Overtemperature Protection fault. Audible alarm activated, message shown on display. Bridging across Klixon contact has failed.	Restart the incubator. If this doesn't solve the problem, call service.

Table 12-1 Heratherm Incubator Error Codes

Error Message & Code	Root Cause	Alarm Response	Alarm Clearing Instructions *
Incorrect voltage (E014)	The applied voltage is too high or too low.	Audible alarm activated, error message shown on display.	Apply the correct voltage as indicated on the nameplate and acknowledge the error.
Sensor Error (E100)	The actual measured value is out of range.	Audible alarm activated, message shown on display. Control transferred to reference sensor. If both sensors are defective, all control circuits will be disabled.	Call service.
Temperature too high (E101)	Actual measured value exceeds permissible range. The Triac is defective.	Audible alarm activated, message shown on display. Process protection activated, control continues on set value.	If the error occurs repeatedly, call service.
Temperature not plausible (E103)	The difference between the control and reference sensors exceeds the maximum permissible deviation, rendering the measurement implausible.	Device uses the sensor that indicates the higher temperature for servo control. Audible alarm activated, message shown on display. Error can be acknowledged and doesn't reset.	If the error occurs repeatedly, call service.
Calibration Value Too High (E104)	The calibration reference value calculated on the basis of the user input falls short of the upper limit for calibration references.	Audible alarm activated, message shown on display. Fall back to previous calibration reference.	Check the external reference sensor for proper function and replace, if necessary. If this doesn't solve the problem, call service.
Calibration Value Too Low (E105)	The calibration reference value calculated on the basis of the user input exceeds the lower limit for calibration references.	Audible alarm activated, message shown on display. Fall back to previous calibration reference.	Check the external reference sensor for proper function and replace, if necessary. If this doesn't solve the problem, call service.
Constant sensor signal (E106)	None of the decimal places of the A/D-converter output for the process sensor has changed over a specific time period.	Audible alarm activated, message shown on display. Use reference sensor. If both sensors are defective, disable all control circuits.	Call service.
Constant reference sensor signal (E107)	None of the decimal places of the A/D-converter output for the process sensor has changed over a specific time period.	Audible alarm activated, message shown on display. Control continues on process sensor, text message on display. If both sensors are defective, disable all control circuits.	Call service.
Heating relay error (E109)	The voltage measurement has indicated a defect in the heater circuit relay.	The device is completely inoperative. Audible alarm activated, message shown on display.	Be sure to pull the power plug and disconnect the device from the AC mains. Call service.

Table 12-1 Heratherm Incubator Error Codes

Error Message & Code	Root Cause	Alarm Response	Alarm Clearing Instructions *
Heating triac error (E110)	The voltage measurement has indicated a defect in the triac.	Audible alarm activated, message shown on display. Overheat protection activated to prevent destruction of the samples. Audible alarm returns upon acknowledgement.	Call service and switch the device off.
Temperature too high (E111)	Actual measured value exceeds permissible range.	Audible alarm activated, message shown on display. Heater turned off until upper limit of hysteresis is recovered. Servo control operations continue. Alarm can be acknowledged, and goes away when the difference between the actual and set values ceases to exist. Note: This error does not indicate a defective triac!	Open the door to speed up cool-down. Open the door to speed up cool-down. Check whether the device was loaded with a hot object, if so, remove. Ensure that the equipment was operated with at least one perforated shelf and with the door not opened longer than 10 min. If this doesn't solve the problem, call service.
Sensor error (E112)	The measured actual value is out of range.	Audible alarm activated, message shown on display. Control continues on process sensor. If both sensors are defective, all control circuits will be disabled.	Call service.
Sensor error (E113)	The actual measured value is out of range.	Audible alarm activated, message shown on display.	Call service.
Watchdog error (E115)	Watchdog test failed on power-up.	Audible alarm activated, message shown on display.	Call service.

*.The rectification of an error is deemed to have been successful when the audible alarm stops sounding, the alarm relay drops out and the message disappears from the control panel display.

Technical Data

The technical data are valid only for an empty device equipped with three shelves, a spray-painted outer enclosure and a power line voltage 230 V/50 Hz. Options may have an impact on the specified performance.

Table 13-1 Technical Data - IGS Series - Table-top Units

Parameter	Unit	IGS 60	IGS 100	IGS 180
Process				
Work space atmosphere				
Min.	°C/°F	Ambient temperature plus 5 °C/41 °F	Ambient temperature plus 5 °C/41 °F	Ambient temperature plus 5 °C/41 °F
Max.	°C/°F	75 °C/167 °F	75 °C/167 °F	75 °C/167 °F
Temperature deviation from set value at 37 °C (98.6 °F), spatial. Max. value/Typical value	K	±0.7/ ±0.6	±0.7/ ±0.6	±0.7/ ±0.6
Temperature deviation from set value at 37 °C (99 °F), over time	K	±0.2	±0.2	±0.2
Heat-up time (work space unoccupied, from 25 °C (77 °F) to 98% of set temperature of 37 °C/99 °F)	min	20	25	35
Recovery time (work space unoccupied, door open for 30 s, to set temperature) Max. value/Typical value	min	5/3	5/4	5/3
Heat dissipation to environment (at set temperature of 37 °C (99 °F) and room temperature of 25 °C/77 °F)	W	21 ±10%	26 ±10%	31 ±10%
Overall dimensions				
Height	mm/in	720/ 28.3	820/ 32.3	920/ 36.2
Width	mm/in	530/ 20.8	640/ 25.2	640/ 25.2
Depth	mm/in	565/ 22.2	565/ 22.2	738/ 29.1
Overall weight	kg/lbs	40/88	51/112	65/143
Loading capacity				
Loading capacity per shelf	kg/lbs		25/55	
Max. overall loading capacity per device	kg/lbs	50/110	50/110	75/165
Electrical data				
Power rating	W	300	520	710
Max. Current	A	1.3	2.3	3.1
Earthing system (e.g. 1/N/PE)		1/N/PE	1/N/PE	1/N/PE

Table 13-1 Technical Data - IGS Series - Table-top Units

Parameter	Unit	IGS 60	IGS 100	IGS 180
Power line frequency	Hz		50/60	
Power line voltage +/- 10 %	V		230	
IP protection system			IP 20	
Protection class			I	
Overvoltage category as per IEC 60364-4-443			II	
Device fusing, building side	A		16	
Device fusing, on PCB	A		2 x 16	
Environmental conditions				
Min. ambient temperature	°C/°F		18/65	
Max. ambient temperature	°C/°F		32/90	
Max. humidity in service, non condensing	% r.F./ % r.H.		80, non condensing	
Min. storage temperature	°C/°F		20/68	
Max. storage temperature	°C/°F		60/140	
Max. humidity in storage, non condensing	% r.F./ % r.H.		90, non condensing	
Post-transport acclimation time	h		2	
Noise level	dB(A)		no inherent noise	
Degree of pollution as per IEC EN 61010-1			2	
Site conditions				
Maximum altitude above sea level	m/y ASL		2000/2187	
Minimum side clearance	mm/in		50/2	
Minimum front clearance	mm/in	590 / 23.2	690 / 27.2	814 / 32
Minimum back wall clearance	mm/in		80/3.2	
Minimum bottom clearance	mm/in		200/8	
Minimum top clearance	mm/in		300/12	

Table 13-2 Technical Data - IGS Series - Floor stand units

Parameter	Unit	IGS 400	IGS 750
Process			
Work space atmosphere			
Min.	°C/°F	Ambient temperature plus 5 °C/41 °F	Ambient temperature plus 5 °C/41 °F
Max.	°C/°F	75 °C/167 °F	75 °C/167 °F
Temperature deviation from set value at 37 °C (98.6 °F), spatial. Max. value/Typical value	K	±0.5/±0.5	±1.4/±1.3
Temperature deviation from set value at 37 °C (99 °F), over time	K	±0.4	±0.4

Table 13-2 Technical Data - IGS Series - Floor stand units

Parameter	Unit	IGS 400	IGS 750
Heat-up time (work space unoccupied, from 25 °C (77 °F) to 98% of set temperature of 37 °C/99 °F)	min	65	55
Recovery time (work space unoccupied, door open for 30 s, to set temperature) Max. value/Typical value	min	< 10/8	< 10/8
Heat dissipation to environment (at set temperature of 37 °C (99 °F) and room temperature of 25 °C/77 °F)	W	55 ±10%	70 ±10%
Overall dimensions			
Height (with substructure)	mm/in	1655/ 65.2	1655/ 65.2
Width	mm/in	755/ 29.7	1215/ 47.8
Depth	mm/in	770/ 30.3	770/ 30.3
Overall weight	kg/lbs	145/320	200/441
Loading capacity per shelf or tray	kg/lbs	30/66	30/88
Max. overall loading capacity per device	kg/lbs	75/165	150/330
Electrical data			
Power rating	W	1200	1500
Max. Current	A	5.0	6.5
Earthing system (e.g. 1/N/PE)		1/N/PE	1/N/PE
Power line frequency	Hz	50/60	
Power line voltage +/- 10 %	V	230	
IP protection system		IP 20	
Protection class		I	
Overvoltage category as per IEC 60364-4-443		II	
Device fusing, building side	A	16	
Device fusing, on PCB	A	2 x 16	
Environmental conditions			
Min. ambient temperature	°C/°F	18/65	
Max. ambient temperature	°C/°F	32/90	
Max. humidity in service, non condensing	% r.F./ % r.H.	80, non condensing	
Min. storage temperature	°C/°F	20/68	
Max. storage temperature	°C/°F	60/140	
Max. humidity in storage, non condensing	% r.F./ % r.H.	90, non condensing	
Post-transport acclimation time	h	2	

Table 13-2 Technical Data - IGS Series - Floor stand units

Parameter	Unit	IGS 400	IGS 750
Noise level	dB(A)	no inherent noise	
Degree of pollution as per IEC EN 61010-1		2	
Site conditions			
Maximum altitude above sea level	m/y ASL	2000/2187	
Minimum side clearance	mm/in	50/2	
Minimum front clearance	mm/in	810 / 31.9	670 / 26.24
Minimum back wall clearance	mm/in	120/4.7	
Minimum top clearance	mm/in	200/7.9	

Spare Parts and Accessories

Material No.	Description
50126665	Stacking adapter Heratherm 60L
50126666	Stacking adapter Heratherm 100L
50126667	Stacking adapter Heratherm 180L
50127105	Kit fresh air filter IMH/IMH-S
50127146	Fresh air filter IMH/IMH-S
50127431	Outer door for Heratherm IGS 60, IMH 60, IMH 60-S, OMS 60, OMH 60, OMH 60-S, OGS 60, OGH 60 and OGH 60-S with a door stop on the left side
50127432	Outer door for Heratherm IGS 100, IMH 100, IMH 100-S, OMS 100, OMH 100, OMH 100-S, OGS 100, OGH 100 and OGH 100-S with a door stop on the left side
50127433	Outer door for Heratherm IGS 180, IMH 180, IMH 180-S, OMS 180, OMH 180, OMH 180-S, OGS 180, OGH 180 and OGH 180-S with a door stop on the left side
50127434	Outer door for Heratherm IGS 60, IMH 60, IMH 60-S, OMS 60, OMH 60, OMH 60-S, OGS 60, OGH 60 and OGH 60-S with a door stop on the right side
50127435	Staple feet Heratherm incubators and heating & drying ovens
50127436	Kit door seal for Heratherm 60L
50127437	Kit door seal for Heratherm 100L
50127438	Kit door seal for Heratherm 180L
50127439	Kit door clips for Heratherm 60L / 100L / 180 L
50127440	Door inner panel seal for Heratherm IMH 60 and IMH 60-S
50127441	Door inner panel seal for Heratherm IMH 100 and IMH 100-S
50127442	Door inner panel seal for Heratherm IMH 180 and IMH 180-S
50127443	Levelling foot
50127444	Kit door handle right Heratherm incubators and heating & drying ovens
50127445	Kit door handle left Heratherm incubators and heating & drying ovens
50127446	Kit door handle with lock right Heratherm incubators and heating & drying ovens
50127447	Kit door handle with lock left Heratherm incubators and heating & drying ovens
50127449	Temperature sensor

Spare Parts and Accessories

50127450	Upper door hinge for Heratherm incubators and heating & drying ovens
50127451	Lower door hinge for Heratherm incubators and heating & drying ovens
50127455	Outer door for Heratherm IGS 100, IMH 100, IMH 100-S, OMS 100, OMH 100, OMH 100-S, OGS 100, OGH 100 and OGH 100-S with a door stop on the right side
50127456	Outer door for Heratherm IGS 180, IMH 180, IMH 180-S, OMS 180, OMH 180, OMH 180-S, OGS 180, OGH 180 and OGH 180-S with a door stop on the right side
50127457	Kit operating panel Heratherm General Protocol incubators and heating & drying ovens
50127458	Kit operating panel Heratherm Advanced Protocol and Advanced Protocol Security incubators and heating & drying ovens
50127461	Kit electronic insert Heratherm General Protocol incubators and heating & drying ovens
50127462	Kit electronic insert Heratherm Advanced Protocol and Advanced Protocol Security incubators and heating & drying ovens without main board fan
50127463	Mainboard cable for Heratherm incubators and heating & drying ovens
50127468	Glass door hinges for Heratherm incubators
50127469	Door switch for the right side of Heratherm incubators and heating & drying ovens
50127470	Door switch for the left side of Heratherm incubators and heating & drying oven
50127472	Glass door IGS 60, IMH 60, IMH 60-S
50127473	Glass door IGS 100, IMH 100, IMH 100-S
50127474	Glass door IGS 180, IMH 180, IMH 180-S
50127478	Temperature limiter 180 °C (356 °F), for IMH-S
50127480	Door hook catch for Heratherm incubators and heating & drying ovens with a door stop on the right side
50127481	Door hook catch for Heratherm incubators and heating & drying ovens with a door stop on the left side
50127482	Magnetic door hook catch for Heratherm incubators and heating & drying ovens with a door stop on the right side
50127483	Magnetic door hook catch for Heratherm incubators and heating & drying ovens with a door stop on the left side
50127487	Kit wire-mesh shelf IGS 100 / IMH 100 / IMH 100-S, including 2 shelf supports
50127488	Kit wire-mesh shelf IGS 180 / IMH 180 / IMH 180-S, including 2 shelf supports
50127489	Kit wire-mesh shelf IGS 60 / IMH 60 / IMH 60-S, including 2 shelf supports
50127497	Heating coils for Heratherm IMH-S at a voltage of 120 V
50127498	Heating coils for Heratherm IMH-S at a voltage of 230 V
50127504	Kit Heating coils IMH 120 V
50127511	Kit fan system Heratherm IMH 60 IMH 60-S, OMH 60 and OMH 60-S, IMH 100, IMH 100-S, IMH 180 and OMH 180-S, 120 V

50127515	Kit Heating coils IMH 230 V
50127531	Circulation fan IMH / IMH-S D = 160 mm (6.3 inch), H = 28 mm (1.1 inch)
50127555	Kit fan system Heratherm IMH 60 IMH 60-S, OMH 60 and OMH 60-S, IMH 100, IMH 100-S, IMH 180 and OMH 180-S, 230 V
50127567	Fresh air filter for IMH, IMH-S
50127741	Support stand with castors for Heratherm 60L
50127742	Support stand with castors for Heratherm 100L
50127743	Support stand with castors for Heratherm 180L
50127764	Wire-mesh shelf IGS 60 / IMH 60 / IMH 60-S, including 2 shelf supports
50127765	Wire-mesh shelf IGS 100 / IMH 100 / IMH 100-S, including 2 shelf supports
50127766	Wire-mesh shelf IGS 180 / IMH 180 / IMH 180-S, including 2 shelf supports
50127768	Sample sensor for IMH 60-S / IMH 100-S / IMH 180-S
50127770	Stainless steel perforated shelf IGS 60, including 2 shelf supports
50127771	Stainless steel perforated shelf IGS 100, including 2 shelf supports
50127772	Stainless steel perforated shelf IGS 180, including 2 shelf supports
50127773	Stainless steel perforated shelf IMH 60 / IMH 60-S / OMH 60 / OMH 60-S/OMS 60/100/180, including 2 shelf supports
50127774	Stainless steel perforated shelf IMH 100 / IMH 100-S / OMH 100 / OMH 100-S/OMS 60/100/180, including 2 shelf supports
50127777	Stainless steel perforated shelf IMH 180 / IMH 180-S / OMH 180 / OMH 180-S/OMS 60/100/180, including 2 shelf supports
50127861	Retaining spring for Heratherm incubators and ovens
50127862	Support rail for Heratherm IGS 60, IMH 60, IMH 60-S, OMS 60, OMH 60, OMH 60-S
50127863	Support rail for Heratherm IGS 100, IMH 100, IMH 100-S, OMS 100, OMH 100, OMH 100-S
50127864	Support rail for Heratherm IGS 180, IMH 180, IMH 180-S, OMS 180, OMH 180, OMH 180-S
50128179	Kit Fuses T2A Incubators 120 V
50128184	Sample sensor connection for Heratherm incubators and heating & drying ovens
50128197	Power socket for Heratherm IMH
50128203	Kit Fuses T2A Incubators 230 V
50128212	Fuse holder for Heratherm IMH
50128237	Kit Key for door handle with lock Heratherm
50128265	Lowenstein holder IGS 100 / IMH 10 / IMH 100-S / IGS 180 / IMH 180 / IMH 180-S
50128683	Drip tray IGS / IMH / IMH-S 60L
50128704	Kit Anti-tilt anchor

Spare Parts and Accessories

50128791	Drip tray IGS / IMH / IMH-S 100L
50128792	Drip tray IGS / IMH / IMH-S 180L
50128793	Petri dish holder 50 mm (2 inch) IGS 60 / IMH 60 / IMH 60-S
50128794	Petri dish holder 50 mm (2 inch) IGS 100 / IMH 100 / IMH 100-S
50128815	Petri dish holder 50 mm (2 inch) IGS 180 / IMH 180 / IMH 180-S
50128816	Petri dish holder 90 mm (2 inch) IGS 60 / IMH 60 / IMH 60-S
50128818	Petri dish holder 90 mm (2 inch) IGS 100 / IMH 100 / IMH 100-S
50128819	Petri dish holder 90 mm (2 inch) IGS 180 / IMH 180 / IMH 180-S
50128960	Kit Shelving system with glass door lock IGS 60, IMH 60, IMH 60-S
50128961	Kit Shelving system with glass door lock IGS 100, IMH 100, IMH 100-S
50128962	Kit Shelving system with glass door lock IGS 180, IMH 180, IMH 180-S
50130657	Kit Viton door seal 60 L Heratherm
50130658	Kit Viton door seal 100 L Heratherm
50130659	Kit Viton door seal 180 L Heratherm
50134116	Kit Heating coil IGS 400, 750 120 V, centre
50134117	Kit Heating coil IGS 400, 750 230 V, centre
50134120	Kit Heating coil IGS 750 120 V, outside
50134121	Kit Heating coil IGS 750 230 V, outside
50134122	Kit Heating coil IMH 750 120 V, ring heater
50134123	Kit heating coil IMH 750 230 V, ring heater
50134315	Kit DS bus cable cpl 400 / 750
50134322	Kit glass door cpl 400 HTM
50134323	Kit glass door ri / le cpl 750 HTM
50134326	Door gasket 400 L HTM
50134327	Door gasket 750 L HTM
50134328	Kit profile gasket 750 L HTM
50134329	Kit door conn. clips 400 / 750 HTM
50134333	Kit castors 400 / 750 HTM
50134334	Kit shelf rack set cpl HTM 400 / 750
50135043	Kit electric insert cpl HTM H floorstand
50135044	Kit electric insert cpl HTM S floorstand
50135055	Kit electric insert cpl HTM 3 PH floor
50135056	Kit glass door hinges cpl 400/750 L HTM
50135058	Kit door lock 750 left cpl HTM
50135059	Kit door lock 750 right cpl HTM

50135060	Door outer casing left HTM 400
50135061	Door outer casing right HTM 400
50135062	Door outer casing left HTM 750
50135063	Door outer casing right HTM 750
50135150	Kit temp sensor cpl HTM incubator floor
50135153	Kit door lock 400 right cpl HTM
50135154	Kit door lock 400 left cpl HTM

Device Log

Incubator type:		Part number:		
Serial number:		Service number:		
Location		Operator's note:		
Work carried out		Notes	Date	Signature

Contact

Overview of Thermo Fisher International Sales Organization

Postal address in Germany

Thermo Electron LED GmbH
Robert-Bosch-Straße 1
D - 63505 Langenselbold

Enquiries from Germany:

Phone

Sales 0800 1 536376

Service 0800 1 112110

Fax

Sales/Service 0800 1 112114

E-Mail info.labequipment.de@thermofisher.com

Enquiries from Europe, Middle East and Africa:

Phone. + 49 (0) 6184 / 90-6940

Fax + 49 (0) 6184 / 90-6772

E-Mail info.labequipment.de@thermofisher.com

Postal address USA:

Thermo Scientific
275 Aiken Road
Asheville, NC 28804
USA

Enquiries from North America:

Phone +1 800-879 7767

Fax +1 828-658 0363

E-Mail info.labequipment@thermofisher.com

Enquiries from Latin America:

Phone +1 828-658 2711

Fax +1 828-645 9466

E-Mail info.labequipment@thermofisher.com

Enquiries from Asia Pacific:

Phone +852-2711 3910

Fax +852-2711 3858

E-Mail iinfo.labequipment@thermofisher.com

Thermo Fisher Scientific, Inc.
81 Wyman Street
P.O. Box 9046
Waltham, MA 02454-9046
United States

www.thermo.com