

**Thermo Scientific
Excelsior AS
Operator Guide
A82310100 Issue 5**



Company Information

© Copyright 2013. Thermo Fisher Scientific. All rights reserved.

Thermo Fisher Scientific Inc. (Thermo Fisher Scientific) is the world leader in serving science, offering a unique combination of innovative technologies. Thermo Scientific is a brand name of Thermo Fisher Scientific.

All other trademarks are the property of Thermo Fisher Scientific and its subsidiaries.

Thermo Fisher Scientific makes every attempt to ensure that the information contained in this supporting document is correct and clearly stated, but does not accept responsibility for any errors or omissions. The development of Thermo Scientific products and services is an ongoing process. Please ensure that any published information you use as a reference is up to date and relates to the condition of the product. If necessary, check with your local Thermo Fisher Scientific representative.

This document may not, in whole or in part, be copied, photocopied, reproduced, translated, or converted to any electronic or other form without prior written consent of Thermo Fisher Scientific. All information contained in this manual is proprietary and confidential, and the exclusive property of Thermo Fisher Scientific and is protected by copyright.

Contact Addresses



Thermo Shandon Limited (Trading as Thermo Fisher Scientific), Tudor Road, Manor Park, Runcorn, WA7 1TA, UK

Tel: +44 (0) 1928 534 000; Fax: +44 (0) 1928 534 001

Web: www.thermoscientific.com/pathology

USA Distributor: Anatomical Pathology USA, 4481 Campus Drive, Kalamazoo, MI 49008, USA

Tel: 1-800-522-7270; Fax: +1 269-372-2674

Web: www.thermoscientific.com/pathology



This instrument conforms to the essential requirements of:

In Vitro Diagnostic Directive 98/79/EC

Machinery Directive 2006/42/EC

EMC Statement

This IVD equipment complies with the emissions and immunity requirements of IEC 61326-2-6:2006.

This equipment has been designed and tested to CISPR 11 Class A.

It is intended for use in a laboratory environment by a trained and qualified professional. In a domestic environment it may cause radio interference, in which case it may be necessary to take measures to mitigate the interference.

Safety Information

Thermo Fisher Scientific instruments are designed for convenient and reliable service; however, improper use or handling by a user may damage the instrument, or cause a hazard to health. The instrument must not be used in a manner not specified by Thermo Fisher Scientific. Correct maintenance procedures are essential for consistent performance. It is recommended that users secure a maintenance contract with our service department.

Any problems and queries should be referred to your Thermo Fisher Scientific service department.



The following sections contain important information for the safe setup and use of the instrument, and should be read and understood by the user before using the instrument.

General Safety



This instrument, as supplied, conforms to IEC61010-1 and IEC61010-2-101; however, the addition of chemicals introduces potential hazards. Good Laboratory Practice must be employed and consideration must be given to the potential for hazard when dealing with these chemicals.



Do not use the instrument in close proximity to strong electromagnetic radiation, as these may interfere with the proper operation. The electromagnetic environment should be evaluated prior to operation of the device.



Good Laboratory Practice must be used when handling tissue samples to prevent cross contamination and infection. The user should complete a risk assessment to determine any potential hazards related to tissue handling.



- Do not introduce any source of ignition into, or near, the instrument once it has been loaded with reagents.
- Do not remove any panels or access covers, unless specifically instructed to do so. The instrument does not have any user serviceable parts. Potentially lethal voltages are present inside the instrument.
- The instrument must be properly connected to a good earth (ground) via the Mains input supply and positioned such that it is possible to interrupt the Mains supply at the source by removing the plug from the socket.
- Use only factory approved accessories or replacement parts within the instrument.
- Only use reagents recommended in the operator guide.
- If the Excelsior AS is used in a manner not specified by Thermo Fisher Scientific, the protection provided by the instrument may be impaired.

Disposal of Sealed Lead Acid Batteries

The sealed lead acid batteries within this instrument need to be replaced every three years.

If the instrument has mainly been operated in very low temperatures, or has been exposed to frequent Mains failures, the batteries should be replaced every year.

The battery manufacturers advise their customers to comply with the relevant regulations within their particular country regarding disposal of this type of battery.

The battery used within this instrument is:

- 12 V 12Ah, valve regulated, sealed, lead acid type, rechargeable battery.

This battery is classified as "Class 8 & Group III UN No 2800 Batteries, wet, non-spillable, electric storage, special provision A67", and meets all requirements of the International Air Transport Association (I.A.T.A) Dangerous Goods Regulations.



Batteries cannot be accessed by the customer and must only be replaced by trained service personnel.

Chemical Safety

The introduction of chemicals creates potential hazards. Thermo Fisher Scientific has adopted the following position with regard to the subject of volatile chemicals used in laboratories:



- Customers using non-specified chemicals in the instrument, do so at their own risk.
- All chemicals recommended by Thermo Fisher Scientific have auto-ignition temperatures considerably above any surface temperatures that can be reached during a single fault failure on the instrument.
- The instrument contains no source of ignition in any areas of the instrument where chemicals are stored, or likely to leak into, in a single fault condition.
- The operator is fully aware of the contents of the specification documents detailing the properties of the chemicals they are using.
- The operator has carried out any legally required assessment of chemicals used and is using Good Laboratory Practice.
- Some chemicals which may be used during operation are flammable - do not use sources of ignition in the vicinity of the instrument when it is loaded with reagents.



- Harmful chemical vapours such as Xylene or Toluene may be emitted during the normal operation of some instruments and the operator should be aware of suitable precautions and safety measures.

Environment

This instrument is required to comply with the European Union's Waste Electrical and Electronic Equipment (WEEE) Directive 2002/96/EC. It is marked with the following symbol:



Thermo Fisher Scientific has contracts with one or more recycling / disposal companies in each EU Member State, and this product and packaging should be disposed of or recycled through them. For further information contact your Thermo Fisher Scientific service representative.

Warranty Statement

Thermo Fisher Scientific is proud of their quality, reliability and of our after-sales service. We continuously strive to improve our service to our customers.

Please ask your distributor or Thermo Fisher Scientific representative about service contracts which can help maintain your instrument in an optimal operating condition.

Warranty provisions necessarily vary to comply with differences in national and regional legislation. Specific details can be found in the delivery documentation or from your dealer or representative.

Please note that your warranty may be invalidated if:

- This instrument is modified in any way, or not used as intended by Thermo Fisher Scientific.
- Accessories and reagents which have not been approved by Thermo Fisher Scientific are used.
- The instrument is not operated or maintained in accordance with instructions.

Symbols

The following symbols and conventions may be used throughout this document and on the instrument:



This symbol is used on the instrument, or in a document, to indicate that instructions must be followed for safe and correct operation. If this symbol appears on the instrument, always refer to the operator guide.



This symbol is used on the instrument, or in a document, to indicate that there are potential biological risks associated with the instrument and / or with instrument use. Always use Good Laboratory Practice.



This symbol is used on the instrument, or in a document, to indicate that irritants or potentially harmful chemicals are present. Refer to the Material Safety Data Sheets for the products, and always use Good Laboratory Practice.



This symbol indicates that a surface is hot. If this symbol appears on the instrument, always refer to the operator guide.



Manufacturer.



This symbol is used on the instrument, or in the document, to indicate that instructions for use must be consulted.

How to use this Guide

Introduction

The Thermo Scientific Excelsior AS (referred to as Excelsior AS) is intended for use in pathology laboratories by operators familiar with tissue processing techniques and laboratory equipment.

Before operating the Excelsior AS, ensure that you have read and understood the Safety Information and the relevant sections in this Operator Guide.

Chapter Summary

This Operator Guide is structured to let you start processing quickly and safely with Excelsior AS.

Chapter 1 - Introduction to Excelsior AS

This chapter gives a tour of the instrument and its features. It describes the different parts of the instrument and gives general information about using Excelsior AS.

Chapter 2 - Installation and Setup

This chapter is a guide to installing and setting up Excelsior AS.

Chapter 3 - Basic Operation

This chapter explains how to load and process specimens using Excelsior AS on a day-to-day basis.

Chapter 4 - Advanced Operation

This chapter is for advanced users and administrators and describes how to change the instrument's settings and create processing programs.

Chapter 5 - Cleaning and Maintenance

This chapter describes how to clean and maintain Excelsior AS to ensure that processing is safe, efficient and reproducible.

Chapter 6 - Troubleshooting

This chapter is intended to help identify and resolve common faults and issues.

Table of Contents

Chapter 1 – Introducing the Thermo Scientific™ Excelsior™ AS.....	15
Introduction to Excelsior AS	16
IVD Intended Use	16
Tissue Cassettes	16
Approved Reagents	16
Identification of Parts.....	17
System Specifications	18
Mechanical Specification	18
Electrical Specification	18
Interface Connections.....	18
Fuses.....	19
Environmental Specification	19
The Excelsior AS Interface	20
Using the Touch Screen.....	20
Menus, Options and Buttons.....	21
On-screen Help	21
The Main Screen and Information Bar	22
Chapter 2 - Installation and Setup	25
Unpacking and Moving the Instrument	26
Unpacking.....	26
Moving the Instrument.....	26
Instrument Positioning and Setup.....	27
Centre of Gravity Positions.....	27
Levelling the Instrument.....	28
Fitting the Filters	29
Connections.....	31
Connecting to Mains Power	31
Connecting a Remote Alarm.....	32
Connecting an Autodialer	33
Connecting to a Laboratory Information Management System (LIMS)	34
Initial Setup	35
Instrument Start-up Procedure	35
Setting the System Time and Date.....	37
Configuring Reagents.....	39

Defining Reagent Names	39
Setting Reagent Storage Temperatures	40
Setting Use Limits	42
Loading Reagents.....	43
Running the Load Sequence	44
Loading Wax	45
Loading Flush Reagents	47
Flushing the Reaction Chamber.....	48
Loading Dehydrants	49
Loading Clearants	50
Loading Fixatives	52
Making Additional Changes Before Processing.....	53
Chapter 3 – Basic Operation	55
Routine Processing.....	56
Loading Specimens	57
Setting the Fill Level	59
Starting a Program.....	60
Quality Control Checks	61
Instrument Faults	61
Monitoring a Program	62
Adding Specimens.....	64
Stopping a Process.....	66
Aborting a Program.....	67
Completing a Program	67
Draining the Reaction Chamber	68
Cleaning the Reaction Chamber	69
Flushing the Reaction Chamber.....	70
Flushing the Instrument	71
Advanced Processing	72
Selecting a Program	72
Changing Program Parameters.....	73
Adjusting the End Time	74
Changing the Start Step.....	75
Changing the Delay Settings.....	76
Changing the Delay Step	77
Quality Control, Filter and Reagent Renewal Limits.....	78

Filter and Reagent Usage Information	78
Wax Discard and Reagent Rotation Information	79
Renewing Fixative Reagents	80
Renewing Flush Reagents.....	82
Renewing Dehydrants, Clearants and Infiltrants Using Rotation	83
Postponing Reagent Rotation	86
Reagent Rotation Example.....	87
Chapter 4 - Advanced Operation	91
Reagent Management.....	92
Configuring and Loading Reagents.....	92
Reagent and Filter Quality Control.....	92
Reagent, Wax and Filter Checks	92
Displaying Detailed Reagent Information	94
Inspecting reagents and waxes	95
Inspecting a Reagent.....	96
Discarding a Reagent after Inspection	97
Loading a Reagent or Wax After a Discard.....	98
Rotating a reagent or wax after a discard	98
Running and Viewing Reports.....	99
Reagent Rotation	101
Triggers for Reagent Rotation.....	101
Requesting Reagent Rotation.....	104
Concept Demonstration	106
Customisation and Workflow	107
Customising Your Instrument	107
Setting the Workflow Processing Options.....	109
Programs and Flushes.....	111
Viewing Program or Flush Details	112
Creating a New Program or Flush.....	116
Editing a Program or Flush.....	119
Start Type.....	124
Access Code Protection	125
Enabling Access Code Protection.....	126
Adding a New System User.....	127
Granting Access to a Function	128
Removing Access to a Function	128

Deleting a System User	129
Audio and Remote Alarms	130
Using Audio and Remote Alarms.....	130
File Operations	132
Saving Programs and Flushes	133
Loading Programs and Flushes.....	134
Loading and Saving Setup.....	139
Setting Laboratory Information Management System (LIMS) Messages.....	140
Language.....	140
Changing the Display Language	140
Customer Services	141
Chapter 5 - Cleaning and Maintenance.....	143
Cleaning Safety and Tasks.....	144
Cleaning Safety.....	144
Clearing Spillages.....	145
Daily and Weekly Cleaning Tasks	145
Wax and Wax Baths.....	146
Discarding Used Wax	146
Cleaning the Wax Bath.....	146
Reagent and Flush Bottles	147
Cleaning the Reagent Supply Bottle Dip Tubes	147
Cleaning the Flush 3 Water Bottle.....	148
General Cleaning and Maintenance	149
Cleaning the Display	149
Changing Filters	149
Regular Maintenance Checks.....	150
Instrument Shutdown Procedure	150
Unloading Reagents.....	151
Chapter 6 -Troubleshooting	155
Faults	156
Alert Icons	156
Using the Fault Status Screen.....	158
Processing Problems - Soft, Spongy Tissue.....	160
Processing Problems - Hard, Brittle Tissue	161
Frequently Asked Questions.....	162
Appendices	173

Appendix A - Accessories.....	174
Accessories Baskets.....	174
Extraction Adaptor Kits.....	174
Filters.....	174
Reagent Bottles and Wax Kits.....	175
General.....	175
Appendix B - Fitting the Optional Vent Adapters.....	176
Extraction Vent Adapter.....	176
Downdraft Extraction Vent Adapter.....	176
Appendix C – Repacking Instructions.....	177
Appendix D - Approved Reagents.....	181
Appendix E - Program Examples.....	182
Routine Overnight.....	182
Daytime Rapids.....	183
Standard Flush Program.....	183
Extended Flush Program.....	183
Appendix F - Screen Maps.....	184
Main Screen.....	184
Process.....	185
Flush.....	186
Quality Control.....	187
Options.....	188
Index.....	190

Chapter 1 – Introducing the Thermo Scientific™ Excelsior™ AS

Welcome to the Excelsior AS Operator Guide.

This chapter introduces Excelsior AS and provides an overview of the instrument.

The following subjects are covered:

- Introduction and compatibility
- System interface
- Identification of parts
- System specifications
- Getting help

Introduction to Excelsior AS

The Thermo Scientific Excelsior AS is an enclosed automated tissue processor. It combines custom programming with simple operation and reagent management.

Specimen cassettes are loaded into the instrument in organised or Random baskets. Up to 222 cassettes can be processed at any one time in Organised baskets; optional accessories allow up to 300 cassettes to be processed simultaneously.

When you start a processing program, Excelsior AS moves through the process steps, drawing in reagents in turn and agitating the baskets to stir reagent around the specimens. The instrument can be set up to heat the chamber and put the chamber under constant or cycled vacuum conditions for individual process steps. Samples can be processed unattended either overnight or during the day.

For more information and step-by-step instructions, refer to Routine Processing on page 56. If you require more flexibility, refer to Advanced Processing on page 72 for information on how you can take full control of processing parameters.

IVD Intended Use

The Excelsior AS is an in vitro diagnostic device.

It is intended to be used in a laboratory environment for the fixation, dehydration, clearing and infiltration of pathology specimens prior to embedding and sectioning and subsequent processing and diagnosis by a pathologist.

Tissue Cassettes

These are loaded either into Organised baskets, which are loaded into the instrument in pairs, or a Random basket, which is ideal for larger specimens. Other baskets, including a 50 cassette Organised basket and a SecureSette basket are available. Refer to Appendix A - Accessories on page 174 for details.

Approved Reagents



Excelsior AS must be installed, loaded and used ONLY with reagents from the approved reagent list shown in Appendix D - Approved Reagents on page 181.

You must not use any other reagents with Excelsior AS under any circumstances.

Identification of Parts

The following diagrams identify the different components of Excelsior AS. Familiarise yourself with the location of the Reaction Chamber, USB port, filters, wax baths, waste wax tray, fixative and flush reagent bottles and exchange bottles.

The dehydrants and clearants are stored in the back of the instrument in concealed bottles and cannot be accessed directly.

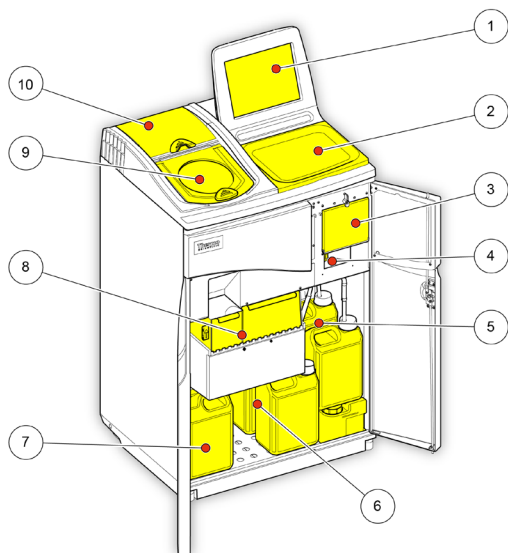

1. Touch screen
2. Removable tray
3. Filter compartment
4. USB port
5. Flush reagent bottles
6. Exchange bottles
7. Fixative bottles
8. Wax baths and waste wax tray
9. Reaction Chamber
10. Downdraft filter compartment

Excelsior AS (front view, doors open)



The USB port is for memory sticks only.

Do not connect any other type of USB device to the Excelsior AS.

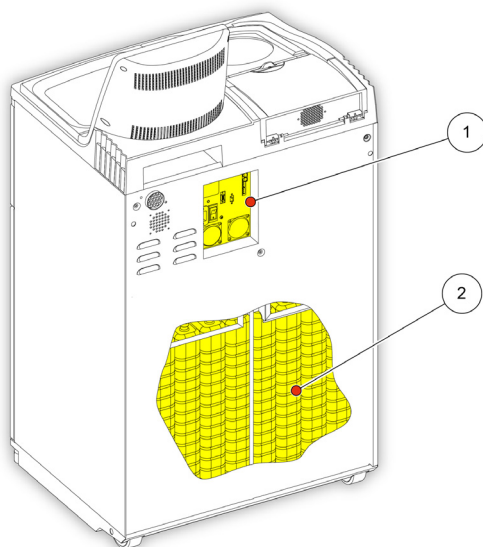

1. Electrical connections panel
2. Concealed reagent bottles

Excelsior AS (rear view)

System Specifications

The specifications of the Excelsior AS instrument are shown in the following tables.



Use safe lifting practices when moving the instrument. Excelsior AS weighs approximately 165 kg (363 lb) when empty and 250 kg (551 lb) when full. At least two people are required to safely move the instrument.

Mechanical Specification

Width	710 mm (26.5 in)
Depth	580 mm (20.5 in)
Height to working area (with tray)	1080 mm (42.5 in)
Height to top of monitor	1370 mm (54 in)
Weight with no reagents	165 kg (363 lb)
Weight with typical reagents	250 kg (551 lb)

Electrical Specification

Power Supply Voltages	100 - 240 VAC (-) <i>Maximum supply voltage fluctuations not to exceed $\pm 10\%$ of nominal voltage.</i>
Frequency	50 / 60 Hz
Power	1300 VA (maximum) 300 VA (typical)

Interface Connections

Remote Alarm	24 V DC, 3A max, operation non-powered output <i>The external remote alarm must comply with IEC60950 or IEC61010-1.</i>
LIMS	Serial RS232
Netmon	RJ45

Fuses



Fuses must be replaced by technically competent personnel.

Remote alarm fuses (x 2)	F 5A 250V
--------------------------	-----------

Environmental Specification



For indoor use only.

Temperature (operating limits)	+5°C to +40°C (+41°F to +104°F)
Temperature (recommended operation)	+15°C to +30°C (+59°F to +86°F) Performance may deteriorate when operated outside this temperature range.
Temperature (transit/storage)	-25°C to +55°C (-13°F to 131°F), +70°C (158°F) for short exposure.
Humidity	Maximum 80% RH at 31°C (88°F) decreasing linearly to 50% RH at 40°C (104°F)
Altitude	Up to 2000 m (6500 feet)
Pollution Degree	2
Over Voltage Category	II

The Excelsior AS Interface

Excelsior AS has a compact and informative user interface that displays the following information:

- Context sensitive help.
- Reaction Chamber status, program details and process status.
- Graphics, showing processing and reagent movement in real time.

Using the Touch Screen



The Excelsior AS touch screen user interface is used to initiate processing and set system preferences and settings. To use the screen, simply press the button corresponding to the function that you want to use. For some tasks, for example reviewing quality control information, select the required reagent container, wax bath or filter by touching the picture that corresponds to the item.

Note

Avoid using sharp or pointed objects to press buttons on the touch screen. Use a finger (with or without gloves), or, if you require a stylus, use the eraser-tipped end of a pencil.

Number Pad

The on-screen number pad is used to enter access codes and define some instrument settings.

- To clear the entered value back to zero, press .
- To delete the last digit that you entered, press .



The on-screen number pad

Note

*If you enter an invalid value it is shown in red text. You will not be able to press **OK** on the screen until the value is corrected.*

Keyboard

The on-screen keyboard appears when you need to define or change the names of reagents, programs, flushes and system users.

- Press the appropriate keys to edit text in the text box above the keyboard.
- To save your changes and return to the previous screen, press **OK**.
- For special characters, press the **Alt** key.



Example special characters

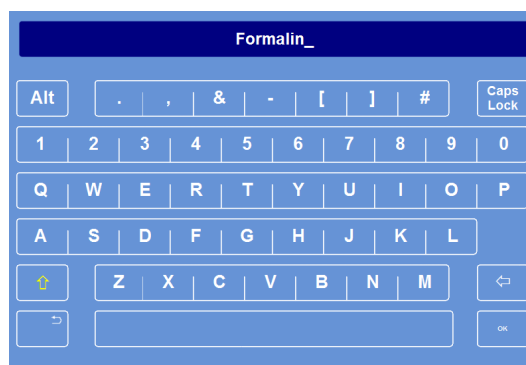

The on-screen keyboard

Menus, Options and Buttons

The touch screen interface lets you perform tasks intuitively, efficiently and consistently. Refer to Appendix F - Screen Maps on page 184 for a diagrammatic representation of the instrument's menu options and the screens that are accessible from the touch screen.

OK and Back Buttons

If you change system settings or create new programs, ensure that you press the correct button to exit from the screen.



Takes you back to the previous screen and saves any changes you made to settings on the current screen.



Takes you back to the previous screen without saving the changes that you made to any of the settings on the current screen.

Using the Up and Down Buttons to Set Values

When you are setting the system time and date, you will be presented with a set of up and down arrow buttons. Press these buttons to set the required time or date. See Setting the System Time and Date on page 37.



Up and down arrow buttons

Selected Settings In Yellow

Some instrument settings can be selected or enabled by pressing on the required option.

When selected, the text is displayed in yellow rather than white.

For example, three processing options are available (Single Program, Daytime Overnight or No Default); the one in use (Daytime Overnight) is shown in yellow.



The selected setting is shown in yellow

On-screen Help

Excelsior AS includes context-sensitive on-screen help to quickly answer any queries you may have about the operation and setup of the instrument. More detailed information is provided in this Operator Guide.

- To display on-screen help, press the  icon which is displayed in the top right of each screen.
- To continue, press **OK** to close the help window.

The Main Screen and Information Bar

The Main Screen provides access to all of the functions that are required to initiate programs and flushes, check the status of the reagents and filters, and configure the instrument to meet the requirements of your own laboratory.

Note

For a full set of screen maps showing how the instrument's software menus and options are organised, see Appendix F - Screen Maps on page 184.

Menu Options

The main menu is located on the right side of the Main Screen:



The Main Screen

The following menu options are available:

- **Process:** This opens either the Reaction Chamber Available screen, from where you can start a processing program, or the Reaction Chamber Not Available screen, if there are no reagents loaded or the chamber is not prepared to start.
- **Flush:** This opens the Select Flush screen. From here you can start programs to flush the instrument.
- **Quality Control:** This opens the Quality Control screen. From here you can visually inspect reagents in the chamber, review use counts for reagents and filters and view and print quality control reports. Warning triangles provide visual alerts to problems that may affect processing.
- **Options:** This opens the Options menu which provides access to menus and settings that enable the instrument to be customised and configured.

Information Bar

The Information Bar is located at the bottom of the interface.



System information displayed at the bottom of the interface

It displays the following information:

- System date and time:** The current date and time.
See Setting the System Time and Date on page 37.
- Alert icons:** These include quality control alerts and hardware issues.
See Alert Icons on page 156.
- Instrument ID and Customised text:** Customisable text that can be used to record customer-specific information about the instrument.
See Customising Your Instrument on page 107.

Gauges, Reaction Chamber Status and Reagent Monitoring

On the left side of the Main Screen is a series of gauges for monitoring the status of reagents and associated components. The following gauges appear in the top-left position on the Main Screen:

Alcohol Quality



This gauge shows the quality of alcohol used in the A1 bottle. Quality is determined using specific gravity measurements. When the specific gravity falls beneath a specified value (shown on the Alcohol Quality Gauge as the red area), you will be prompted to rotate reagents to maintain the quality of processing. See Alcohol Quality Warning on page 83.

The red area is adjustable up or down in steps of approximately 1.25%. The black line indicates the factory default setting which is approximately 45%.

Pressure



This gauge shows the pressure in the Reaction Chamber. The value will rise and fall during processing according to the vacuum conditions specified in the selected program and as reagents are drawn into and drained out of the Reaction Chamber.

The Reaction Chamber lid can be opened when the value is in the green area of the gauge.

Temperature



This gauge shows the temperature in the Reaction Chamber. The value will rise and fall during processing according to the conditions specified in the selected program.

Reaction Chamber and Containers

On the left side of the Main Screen is a graphical representation of the Reaction Chamber and various reagent containers. The level of reagents indicated in these will change during processing, reagent inspection, reagent renewal and rotation.

The following colours represent the type of reagent in each of the containers:

- Green – Water-based (fixatives and Flush 3)
- Blue – Dehydrants (alcohol and Flush 2)
- Red – Clearants (xylene and Flush 1)
- Yellow – Wax / Paraffin



Reaction Chamber



Waste wax tray

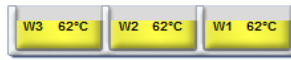

Wax baths



Flush bottles

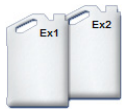

Exchange bottles

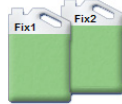

Fixative bottles

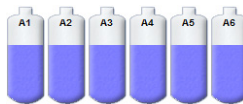

Reagent bottles: dehydrant (alcohol)

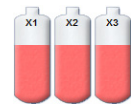

Reagent bottles: clearant (xylene)

Chapter 2 - Installation and Setup

This chapter describes the installation and setup procedures for Excelsior AS and covers the following subjects:

- Unpacking and positioning the instrument.
- Fitting the filters into the instrument.
- Connecting the instrument to mains power and switching on.
- Choosing the display language and setting the system time and date.
- Defining and loading reagents in preparation for specimen processing.

Note

If Excelsior AS has already been installed and the required reagents have been loaded, read Chapter 3 – Basic Operation from page 55 for a description of the routine operation of the instrument.

Unpacking and Moving the Instrument

Unpacking

Inspect the packaging. If it is damaged, or the contents do not match the supplied packing list, or both, inform your local Thermo Fisher Scientific representative then unpack the instrument and inspect it carefully.

Instructions for unpacking are provided on the packing case.

When unpacking the instrument, do not discard the packaging – store it flat for future use.

Ensure that you have all parts on the packing list. If parts are missing or broken, contact your local Thermo Fisher Scientific representative.

Note

Quote the instrument Serial Number, your Order Number, Invoice Number, Delivery Note (or Packing Slip) Number and the Date in all communications. If you need to transport the instrument, refer to Appendix C – Repacking Instructions on page 177.

Moving the Instrument



Use safe lifting practices when moving Excelsior AS.

At least two people are required to move the instrument.

The instrument should not be moved or tilted when it is loaded with reagents and molten wax.

Excelsior AS weighs approximately 250 kg (551 lb) when fully loaded and 165 kg (363 lb) when empty.

Moving the instrument when empty

Ensure that the transport handles are fitted. Carefully tilt the instrument back and push it on the rear wheels.

Note

On smooth floors, the instrument can be moved without tilting.

Instrument Positioning and Setup

Centre of Gravity Positions

Where seismic regulations require the instrument to be secured, use the handle locations at the rear of the instrument (2 x M8 female threads).

The following diagrams illustrate the centre of gravity positions for an empty Excelsior AS and an Excelsior AS loaded with an average load of reagents:

Empty instrument:

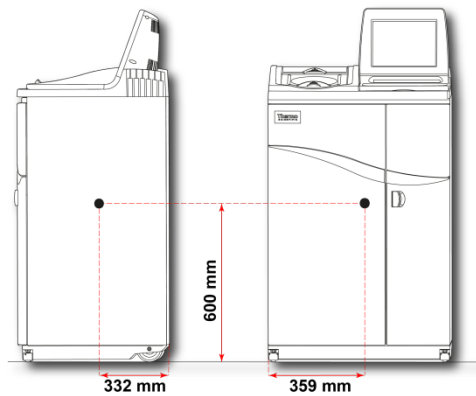

Centre of gravity position (empty)

Instrument with an average load of reagents:

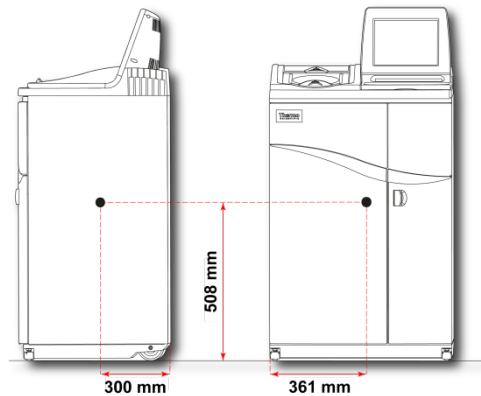

Centre of gravity position (average load of reagents)

Levelling the Instrument



Excelsior AS must be level from front to back.

Before loading the instrument with reagents and wax, ensure that it is fully adjusted.

To level the instrument:

- Move Excelsior AS to its final position. The floor should be level and any floor covering must be non-flammable. There should be at least 95 mm (4 inches) behind the instrument. To maintain this distance, leave the transit handles fitted.
- Open the Reaction Chamber lid, remove the Random basket from the chamber and close the lid.
- If necessary, adjust the front castors to level the instrument. To do this, using the provided wrench (spanner) and adjustment rod, loosen the locknut with the wrench and then turn the castor with the adjustment rod. When the instrument is level, tighten the locknut.

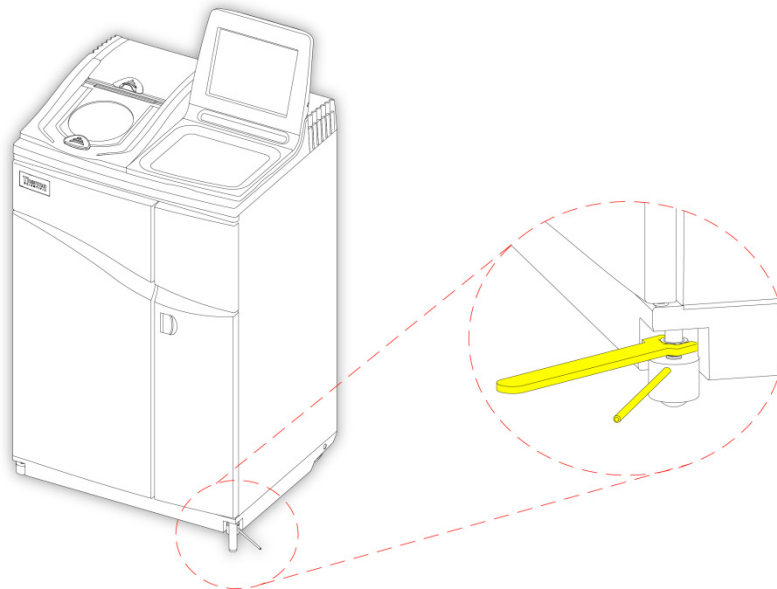

Adjusting the front castors

Note

The factory settings should be sufficient to ensure that the instrument is level when installed.

Fitting the Filters

Excelsior AS is delivered with new filters fitted into the instrument. Plastic wrappers must be removed before use.

For additional information about the filters, refer to Filter and Reagent Usage Information on page 78 and Reagent and Filter Quality Control on page 92.

Note

The filters fit tightly into their slots for efficient extraction. It is recommended that you change the filters every 13 weeks.

Fitting Extraction Filters



Both extraction filters must be fitted; it is not possible to operate the instrument if either filter is missing.

For correct operation of the extraction system, ensure that the doors are closed.

The two main extraction filters, separated by a removable metal baffle, are located in a compartment behind the right door. The upper filter uses potassium permanganate to extract formaldehyde vapours. The lower filter uses charcoal to extract solvent vapours.



If you are replacing filters, remove the old filters from the instrument and install new filters. Dispose of the used filters in accordance with your local regulations and procedures.

To remove and replace the air extraction filters:

- Open the right door of the instrument, turn the filter door latch 90° clockwise and open the filter door.
- Remove the metal baffle plate.
- Slide out the filters and remove the plastic wrapper from each filter.
- Replace the filters in the correct positions (upper = formaldehyde, lower = charcoal) so that the airflow arrow on each filter points up.
- Replace the baffle plate, close the filter door securing it with the latch, and then close the right-hand door.

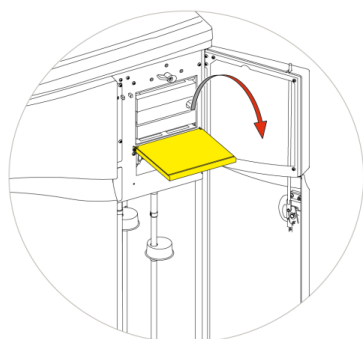

Opening the filter door

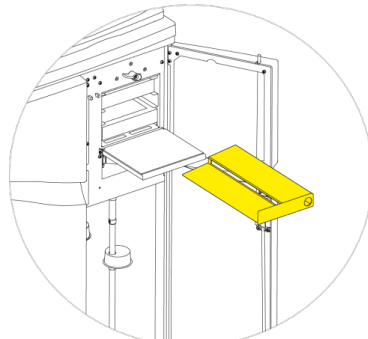

Removing the baffle plate

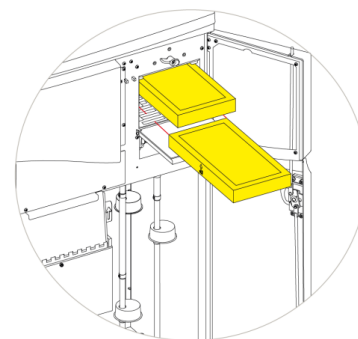

Removing the filters

Note

The red emergency vacuum release is located behind the baffle plate.

Fitting the Downdraft Filter

The downdraft filter (formaldehyde) is at the back of the instrument, behind the Reaction Chamber.



If you are replacing filters, remove the old filters from the instrument and install new filters. Dispose of the used filters in accordance with your local regulations and procedures.

To remove and replace the downdraft filter:

- Open the downdraft filter cover.
- Lift out the filter and remove the plastic wrapper.
- Replace the filter in the correct position, ensuring that the airflow arrow points away from the instrument, and close the filter cover.

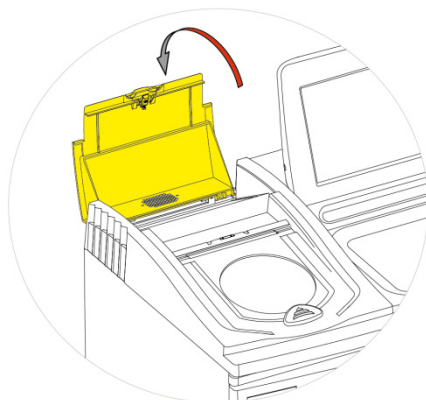

Opening the downdraft filter cover

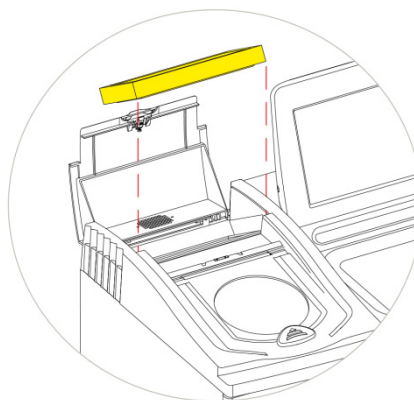

Removing the filter

Optional Vent Adaptors

The optional vent adaptors allow fumes to be extracted from Excelsior AS into a fume cupboard or hood, or vented to the outside atmosphere.

For more information, see Appendix B - Fitting the Optional Vent Adaptors on page 176.

Connections

Connecting to Mains Power

Once Excelsior AS has been unpacked and installed, it can be connected to mains power.



Ensure that the mains supply voltage corresponds with the voltage rating on the rating plate on the back of the instrument.

The ~ symbol on the rating plate indicates that the instrument operates on an alternating current supply (AC).

To connect the instrument to mains power:

- Ensure that the I/O power switch at the rear of the instrument is switched off (O side of the switch pushed in).

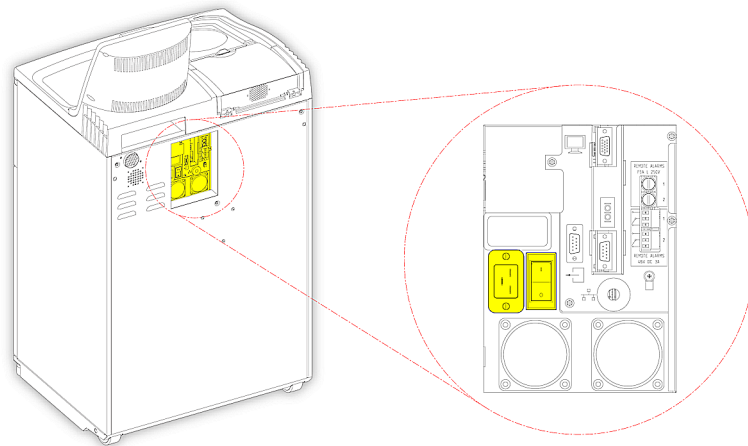

Mains power connections

- Insert the appropriate mains cable into the mains connector on the rear panel of the instrument.
- Connect the mains supply cable to a local power supply outlet.

Connecting a Remote Alarm

Connections for Remote Alarms 1 and 2 are on the back panel of the instrument. For more information, see Audio and Remote Alarms on page 130.

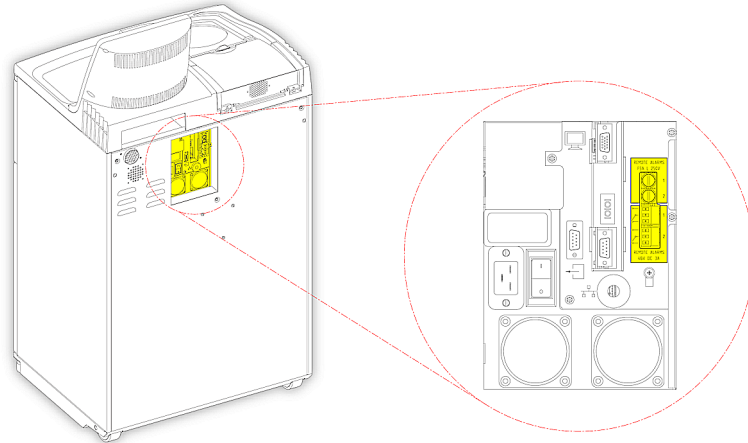

Remote alarm connections

Normal operating conditions for these relays are:

- Relay 1 - unpowered state.
- Relay 2 - powered state.

Note

Relay 2 is used as a power fail alarm and is in the alarm condition when the instrument is first switched on.



External circuits must be connected to the remote alarm socket by a technically competent person. The external circuit should comply with the requirements of either IEC 61010-1 or IEC 60950, or both.

The cable length is to be less than 3 metres.

Connecting an Autodialer

The following two methods can be used when connecting an autodialer to the instrument for remote alarm monitoring.

Typically, connection to Alarm 2 is recommended as this gives a positive alarm state if the instrument shuts down.

- Connection to Alarm 1

Closed: Relay fires when an alarm is generated.

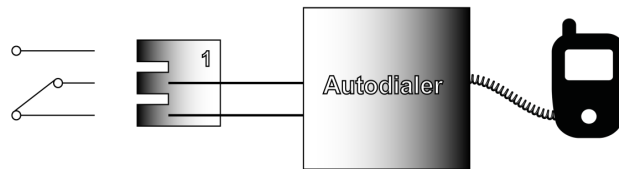

Autodialer connection to Alarm 1

- Connection to Alarm 2

Held Closed: Relay closed and released when an alarm is generated.

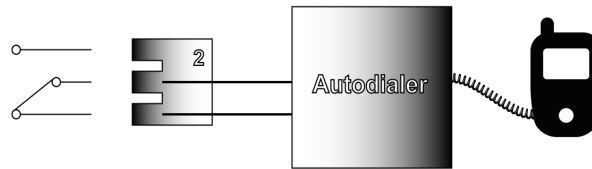

Autodialer connection to Alarm 2

Note

During power-up, alarms will be active but will go to a normal state once the instrument software has loaded.

Connecting to a Laboratory Information Management System (LIMS)

Excelsior AS can be programmed to send user-defined LIMS messages via the serial D-connector (RS-232) on the back of the instrument when specific events occur.

For details on the type of messages that can be sent and how to set them, refer to Setting Laboratory Information Management System (LIMS) Messages on page 140.

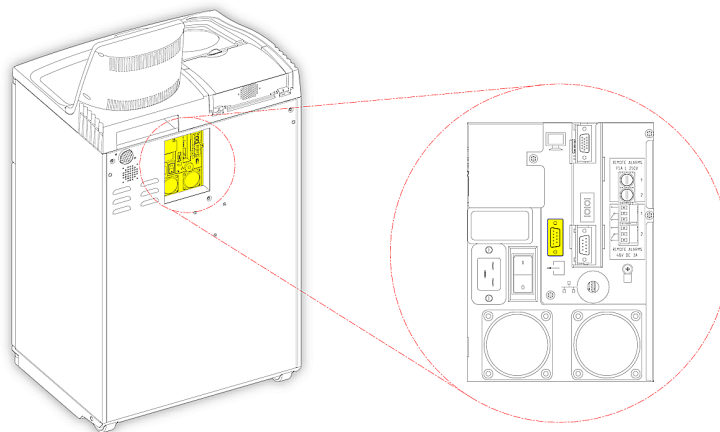

LIMS Serial D-connector

LIMS specification

- Baud rate: 115200
- Bits: 8
- Parity: None
- Stop bits: 1
- Handshaking: Data Terminal Ready (DTR) and Request To Send (RTS)
- Cable length: To be less than 3 metres

Initial Setup

Once the instrument has been unpacked, installed in the required location and connected to mains power, you must then:

- Switch the instrument on.
- Wait for the system software to load.
- Choose the language for the user interface.
- Check the system time and date.
- Configure the reagents that you intend to use.
- Set use limits for fixatives, filters and flush reagents.
- Load reagents into the instrument.

Instrument Start-up Procedure

Once Excelsior AS has been connected it can be switched on.

To switch the instrument on:

- Press the I (ON) side of the I/O power switch.
When Excelsior AS is powered 'ON', you should hear the cooling fans start.
After about 25 seconds, the Thermo Scientific logo is displayed.
After about one minute, the Select a Language screen is displayed.

To select the system language:

- From the Select a Language screen, press the required language and then press OK.
- The Main Screen is then displayed.
For a description of the Main Screen functions, see The Main Screen and Information Bar on page 22.

Note

Notice that all the containers and bottles on the left of the display are empty. When reagents have been loaded into the instrument, they will appear full with colour-coded reagents.



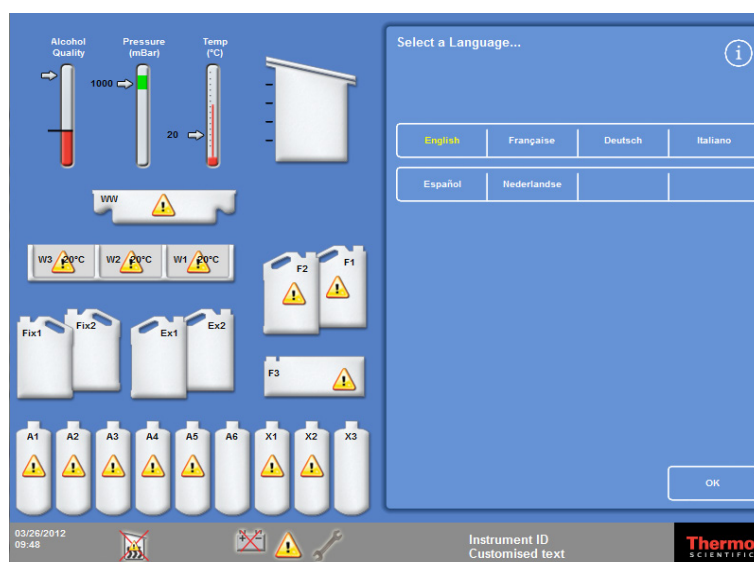

Alert icons are displayed at the bottom of the screen and must be cleared, see Clearing the Alert Icons on page 36.



Selecting the user interface language

Clearing the Alert Icons

When the instrument is first switched on, alert icons are displayed in the grey Information Bar at the bottom of the screen. These icons must be cleared before any further operations.

Icon	How to clear
	<p>Battery Isolation Switch Alert.</p> <p>Turn on the Battery Isolation switch to restore battery backup and ensure power to the instrument. Leave the battery switched on and do not switch it off unless instructed to do so. See below for the location of the switch.</p>
	<p>Reaction Chamber Heater Trip Alert</p> <p>Press the Heater Reset switch to reset the Reaction Chamber heater trip circuit. See below for the location of the switch.</p>
	<p>Quality Control Alert</p> <p>From the Main Screen, select Quality Control to display the Quality Control Screen. Load reagents if required. For more information, see Loading Reagents on page 43 and Quality Control Checks on page 61.</p>
	<p>Hardware Issue</p> <p>Select Options > Faults, or press the wrench (spanner) icon, to display the Fault Status screen. From here, you can clear or acknowledge any faults. For more information, see Using the Fault Status Screen on page 158.</p> <p>Note</p> <p><i>On starting the system, this icon is displayed until the Heater Reset Switch has been pressed.</i></p>

Battery Isolation, Heater Reset and Push to Test Switches

The switches are shown below. The inset shows the view inside the cabinet, behind the right door, above the flush reagent bottles (the pipes have been hidden for clarity):

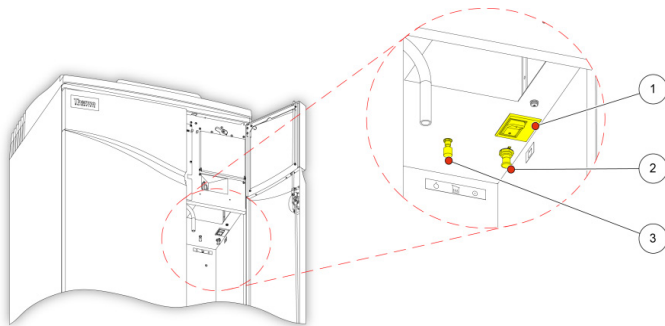

1. Battery Isolation switch
2. Heater Reset Switch
3. Push to Test Switch

Battery Isolation, Heater Reset and Push to Test Switches

Note

When the Heater Reset switch is set and the Battery Isolation switch is turned on, the icons disappear from the display.

When first charging the battery, after switching on both the Main I/O power switch and the Battery Isolation switch, the instrument should be left for a period of 14 hours (overnight) to ensure the battery is fully charged.

The Push-to-Test switch can be used to test the operation of the Heater Reset switch.

Setting the System Time and Date

Once you have selected the display language, check the system time and date and adjust them if necessary.

Note

It is important to set the time and date correctly so that programs start and end at the correct time and on the correct day. Both time and date can be changed later, as required.

To set the system time:

- From the Main Screen, press **Options** to display the Options menu.
- Press **Set Time** to display the Options - Set Time screen.
- To toggle between 12 and 24 hour time format, press **12/24**.

When selected (yellow text), the time is shown in 12-hour format as 'AM' or 'PM'; when not selected it is shown in 24-hour format:

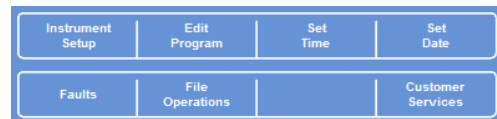

Options menu

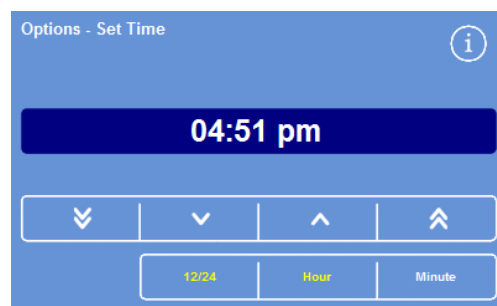



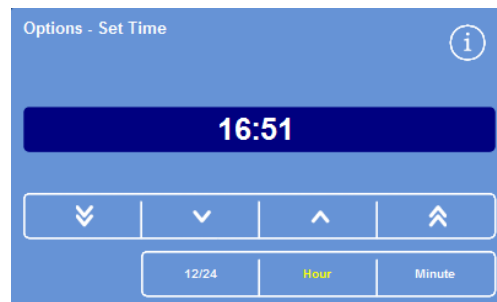

Setting the system time - 12 hour format



Setting the system time - 24 hour format

- Press **Hour** or **Minute** and use the up and down buttons to set the required time.
- Press **OK** to save the time setting and return to the Options screen.
- Press **OK** again to return to the main screen.

-  Moves the time back in 5 minute or 5 hour increments.
-  Moves the time back in 1 minute or 1 hour increments.
-  Moves the time forward in 1 minute or 1 hour increments.
-  Moves the time forward in 5 minute or 5 hour increments.

Up and down buttons

To set the system date:

- From the Main Screen, press **Options** to display the Options menu.
- Press **Set Date** to display the Options - Set Date screen.

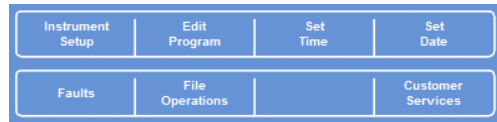

Options menu

- Choose the required date format by pressing the appropriate button. The selected date format is shown in yellow text.

Available date formats are:

dd/mm/yyyy

mm/dd/yyyy

yyyy/mm/dd

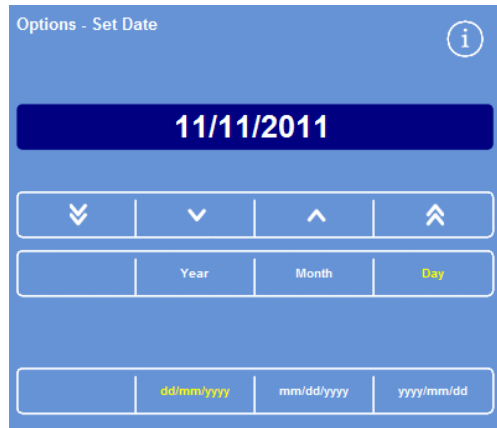

The Options - Set Date screen

- Select **Year**, **Month**, or **Day** and use the **up** and **down** buttons to set the required date.
- Press **OK** to save the date setting.
- Press **OK** again to return to the Main Screen.



Moves the date back in 5 day, 5 month or 5 year increments.



Moves the date back in 1 day, 1 month or 1 year increments.



Moves the date forward in 1 day, 1 month or 1 year increments.



Moves the date forward in 5 day, 5 month or 5 year increments.

Up and down buttons

Note

The time and date are displayed in the bottom left corner of the Screen:



Time and date display

Configuring Reagents

Before you load the reagents into the instrument, you must define the following:

- Names of the fixative, dehydrant, clearant, infiltrant and flush reagents that will be used.
- Storage temperatures for the concealed reagents and infiltrants.
- Use limits for fixatives, filters and flush reagents.

Defining Reagent Names

By default, Excelsior AS uses the following reagent names:

- *Formalin* for the fixatives (fixative bottles Fix 1 and Fix 2).
- *Alcohol* for the dehydrants (concealed reagent bottles A1–A6).
- *Xylene* for the clearants (concealed reagent bottles X1–X3).
- *Wax* for the infiltration reagents (wax containers W1–W3).
- *Flush* for the flush reagents (flush containers Flush 1–3).

These names can be changed, as required.

To define reagent names:

- From the Main Screen, select **Options** > **Instrument Setup**.

The Options - Instrument Setup menu appears:

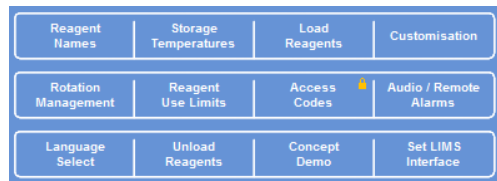

The Options - Instrument Setup menu

- Press **Reagent Names**.

The Instrument Setup - Reagent Names screen appears:

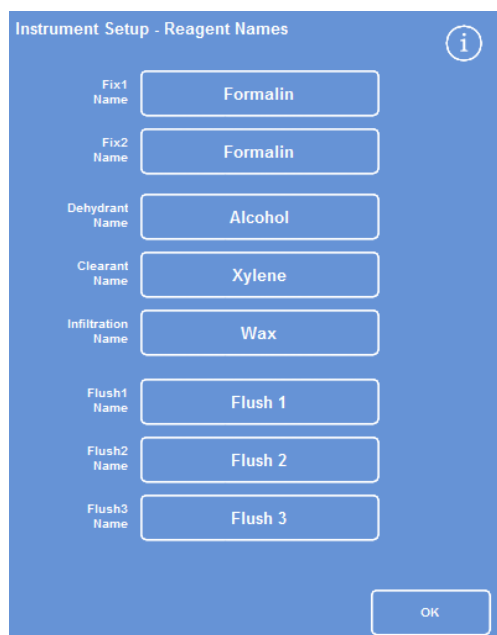

The Instrument Setup - Reagent Names screen

- Press the button corresponding to the name that you want to change:

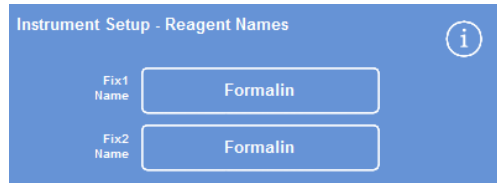

Setting reagent names

- Use the on-screen keyboard to type the new name of the reagent and press **OK**.

Note

A maximum of 18 characters can be used for reagent names.

- Change the names of other reagents, as required.
- Press **OK** to save and return to the Instrument Setup - Reagent Names screen.
- To return to the Main Screen, press **OK** repeatedly.

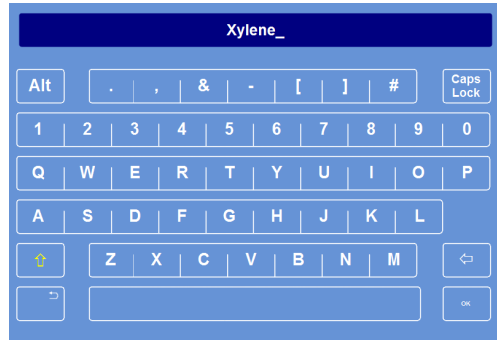

Defining a reagent name using the on-screen keyboard

Note

On-screen, the first letter of the name labels for each of the wax baths, dehydrant bottles and clearant bottles, will change to match the first letter of the new reagent name.

Setting Reagent Storage Temperatures

Excelsior AS can heat the concealed reagents for faster, more consistent processing. The default storage temperatures are 30°C for alcohol and xylene and 62°C for wax. Storage at ambient temperature is available, if required. The instrument will not cool reagents to temperatures lower than ambient.

Note

Wax storage and program temperatures should be set at 4°C above wax melting temperature.

To set wax storage temperature:

- From the Main Screen, press **Options** > **Instrument Setup** > **Storage Temperatures**.
The Instrument Setup - Storage Temperature screen appears:
- Press the **Wax Storage Temp.** value.

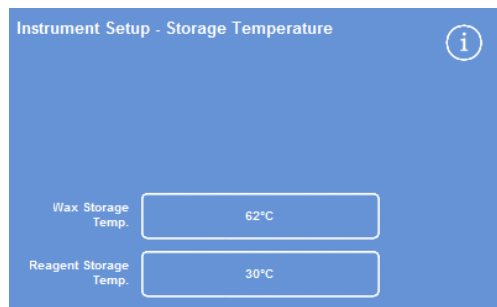

Defining wax storage temperature

The Storage Temperature - Set Wax Storage Temperature screen appears:

- Use the number pad to set the required storage temperature or press **Amb.** to set the storage temperature to ambient.

Note

The wax storage temperature range is 45°C to 65°C and ambient.

- Press **OK** to save and return to the Instrument Setup - Storage Temperature screen.

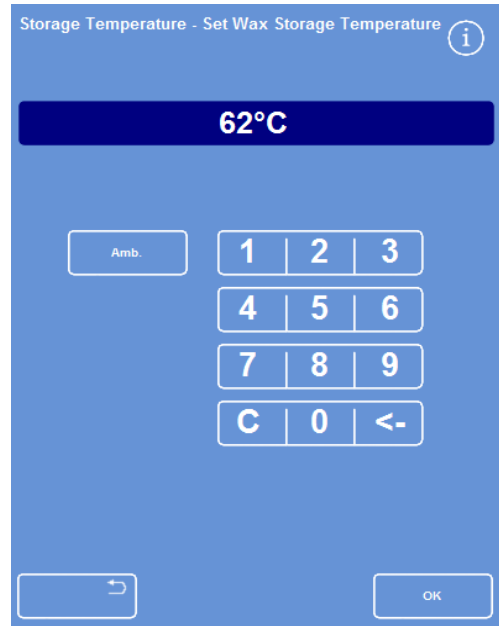

The Storage Temperature - Set Wax Storage Temperature screen

To set reagent storage temperature:

- From the Main Screen, select **Options > Instrument Setup > Storage Temperatures.**

The Instrument Setup - Storage Temperature screen appears:

- Press the **Reagent Storage Temp.** value.

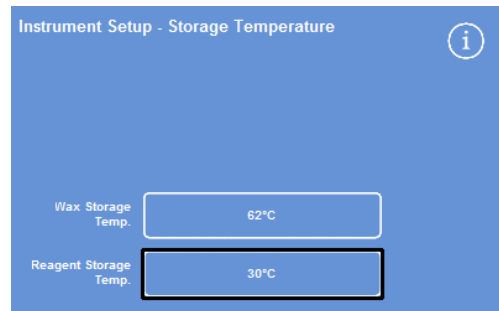

Defining reagent storage temperature

The Storage Temperature - Set Reagent Storage Temperature screen appears:

- Use the number pad to set the required storage temperature or press **Amb.** to set the storage temperature to ambient.

Note

The reagent storage temperature range is ambient to 35°C.

- Press **OK** to save and return to the Instrument Setup - Storage Temperature screen.
- To return to the Main Screen, press **OK** repeatedly.

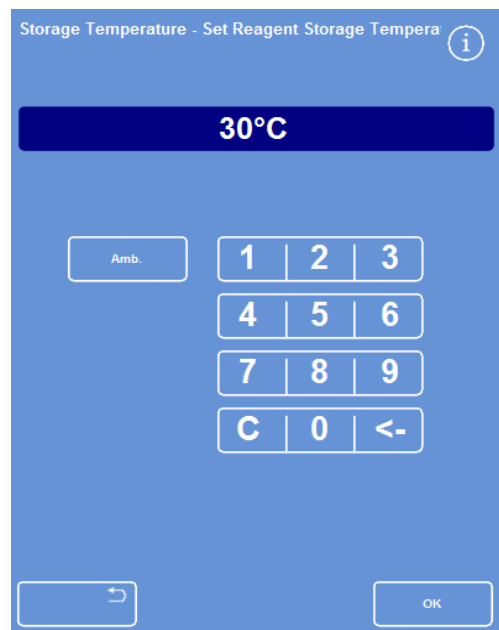

The Storage Temperature - Set Reagent Storage Temperature screen

Setting Use Limits

Excelsior AS tracks the usage of fixatives, filters and flush reagents and provides visual warnings when these need to be changed or renewed on the Quality Control screen. See Quality Control Checks on page 61 and Reagent, Wax and Filter Checks on page 92 for more information.

Use limits should be set before you start processing. They can be changed later, as required.

Note

The renewal of the infiltrant and concealed processing reagents is managed automatically by the system based on the default setting for alcohol quality. If you want to change the way in which these reagents are renewed, refer to Triggers for Reagent Rotation on page 101.

To set use limits:

- Select **Options > Instrument Setup > Reagent Use Limits**.
The Instrument Setup – Reagent Use Limits screen appears.
- Press each reagent / filter button in turn, define the required use limit using the number pad and press **OK**.
- To turn the use limit off, set the value to zero (0).
- When you have defined all the use limits, press **OK** to save and return to the Instrument Setup – Reagent Use Limits screen.
- To return to the Main Screen, press **OK** repeatedly.

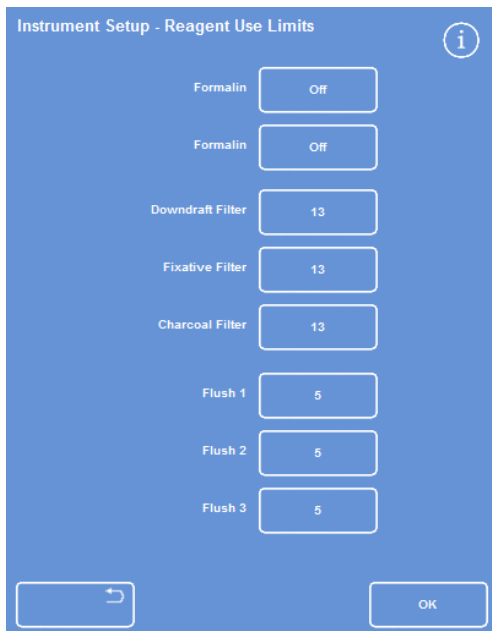

The Instrument Setup - Use Limits screen



Setting use limits

Note

*The use limit for the filters is measured in weeks. The default is 13 weeks.
The flush reagents can only be set from 1 to 5. The default is 5. The use limit for a flush cannot be turned off.*

Loading Reagents

Before you can process specimens, you must load Excelsior AS with the required processing reagents. The names of the reagents that you intend to use are defined using the **Reagent Names** option (see Defining Reagent Names on page 39).

When you load reagents, Excelsior AS will guide you through the loading procedure to ensure that the required reagents are loaded into the correct cabinet positions. You must then insert the colour-coded reagent tubes (with evaporation cap) and confirm that the required reagents have been loaded into the appropriate positions in the Reagent Storage Area.

Reagents must be loaded in the following order:

1. Wax
2. Flush (clearing) reagents
3. Dehydrants
4. Clearants

Fixatives are loaded from the Quality Control screen; you will be prompted to load these when you start a processing run for the first time.



Refer to the Material Safety Data Sheets when handling all reagents used with the instrument. For a full list of approved reagents, see Appendix D - Approved Reagents on page 181.

The Reagent Storage Area

Make sure that you familiarise yourself with the positions of the reagents in the Reagent Storage Area and the colour-coded reagent tubes. The tubes are flexible and can be moved as required to ensure that the tubes fit into the correct reagent container. If you rotate a tube, ensure that it is rotated back to avoid damage or leaks.

When connecting reagent tubes ensure that each pipe is:

- Free of any surface contamination.
- Fully inserted in the relevant bottle and not bent, twisted, kinked or at an angle.

This diagram shows the colour of the tube for each reagent position:

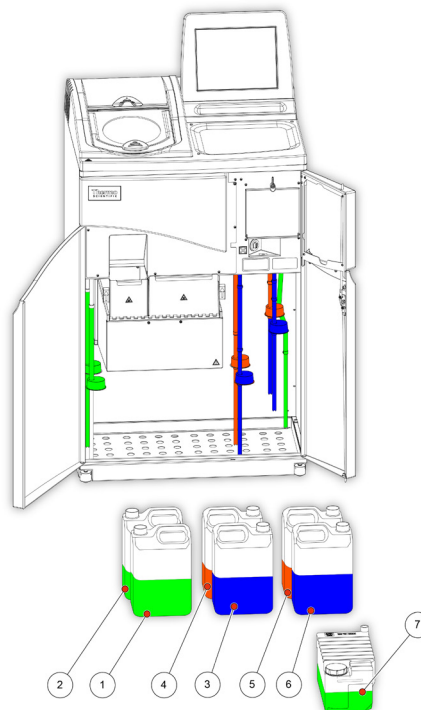

1. Fixative 1
2. Fixative 2
3. Exchange 1
4. Exchange 2
5. Flush 1
6. Flush 2
7. Flush 3

Running the Load Sequence

The Load Sequence takes you through the steps that are required to load reagents into Excelsior AS in the correct sequence.



Ensure that you load the correct reagent and concentration at each step; the instrument cannot check that the correct reagents are loaded.

To initiate the Load Sequence:

- Select **Options > Instrument Setup > Load Reagents** to display the Instrument Setup - Load Sequence screen.

Wax bath W1 is highlighted on the display, ready to be loaded:

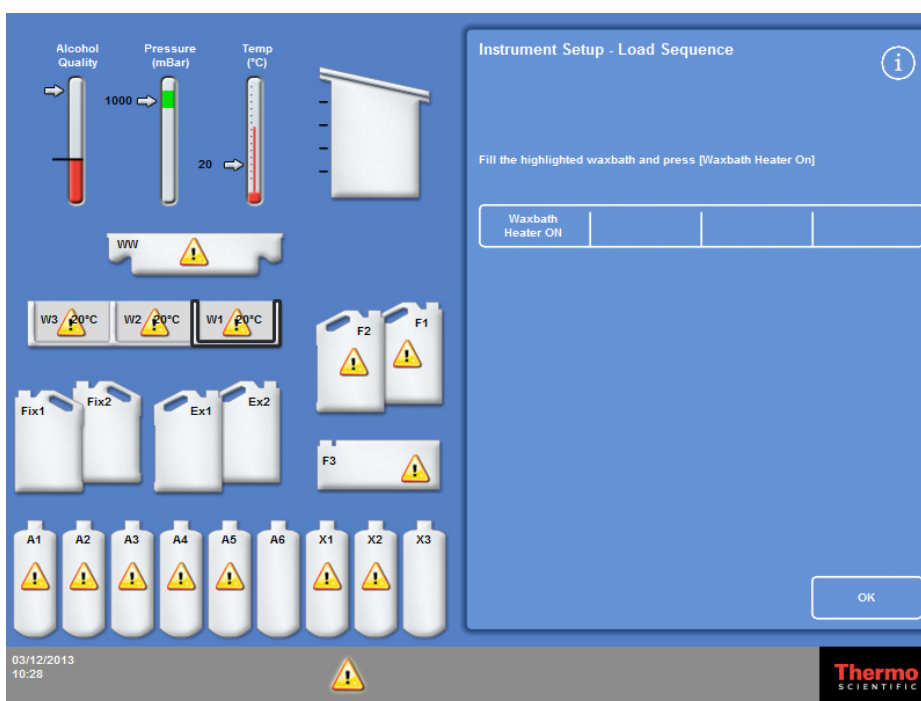

Starting the Load Sequence

Note

Once reagents are loaded and you have completed the Load Sequence, you will not be able to run the **Load Reagents** option again, unless you unload the reagents first. For more information, see *Unloading Reagents* on page 151.

If you exit from the Load Sequence before it is complete (by pressing **OK**), loading will resume when you select the **Load Reagents** option again. You will not be able to run programs unless all reagents are loaded. If you try to do this, you will be prompted to load reagents.

Loading Wax

Wax loading comprises these steps:

- Filling the three wax baths with wax pellets.
- Starting the wax heaters.
- Fitting an empty, consumable waste wax tray and lid.

To load wax:

- Open the instrument's main doors.
- Lift the spring-loaded locking levers and open the two wax doors.
The right-hand wax door (W1 and W2) opens fully; the left-hand wax door (W3) opens to 45°.
- Starting from the right, fill each wax bath with wax pellets.
Use 4.2 kg of wax pellets per chamber to give 5.6 litres of molten wax.

Note

Ensure that the wax pellets are evenly distributed in the wax bath – push them towards the back if necessary.

The wax bath can be filled to within a few millimetres from the top of the dividing wall – the pellets melt to the final, lower level within 4 to 6 hours. Take care not to spill any wax pellets.

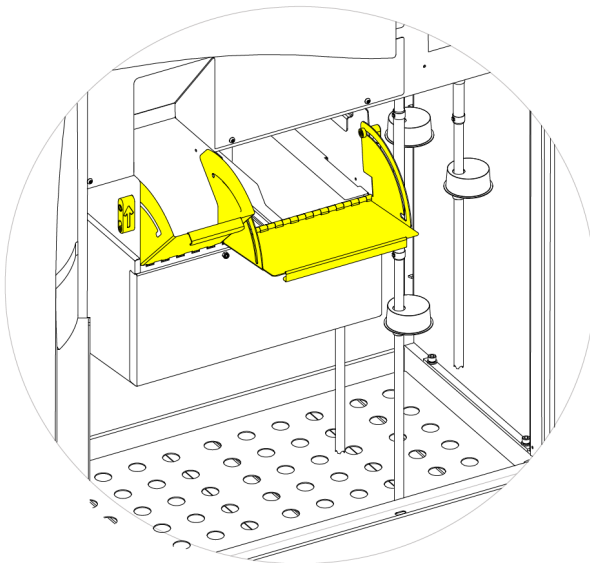

Opening the wax bath doors

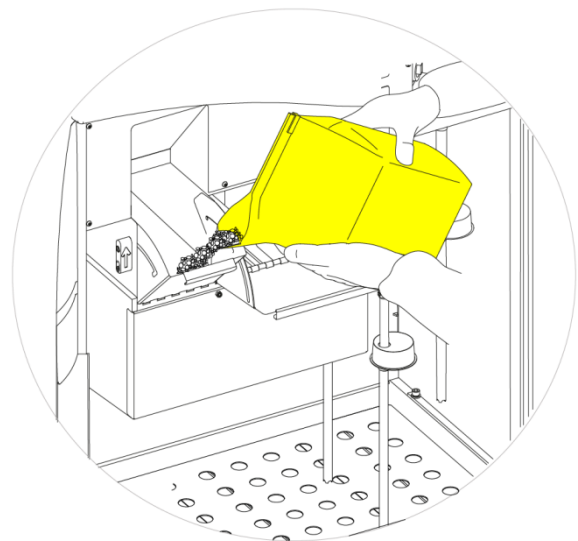

Filling the wax bath



There is a risk of skin burns from molten wax.

Do not fill the Excelsior AS wax baths with molten wax. Use wax pellets only.

To start the wax bath heaters:

Note

Before starting the wax bath heaters, make sure you have filled each wax bath with wax.

- On the Instrument Setup - Load Sequence screen, press **Wax Bath Heater ON** to switch on the wax bath heater and melt the wax pellets in wax bath W1.

Wax bath W1 is now shown filled in yellow on the screen and wax bath W2 is highlighted.

- Press **Wax Bath Heater ON** to heat the wax in W2 and repeat for wax bath W3.
- When the wax has melted, ensure that the level is correct. The maximum and minimum levels are clearly marked in each wax bath.

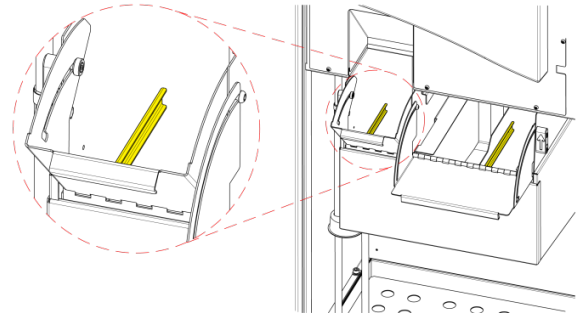

Maximum and minimum wax levels

To fit a consumable waste wax tray and lid:

Note

Do not reuse waste wax trays.

- Ensure that a lid is fitted securely to the consumable waste wax tray.
- Slide the tray into position above the right-hand wax baths.
You may have to wait until the wax has started to melt to fit the waste wax tray into position correctly.
- Close both wax doors.



Do not heat the waste wax tray to above 65°C.
The waste wax tray must not be used with hot water.

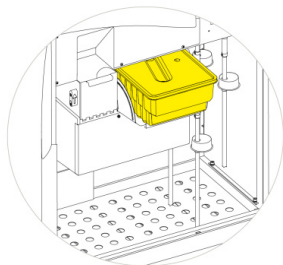

Fitting the waste wax tray above W1 and W2

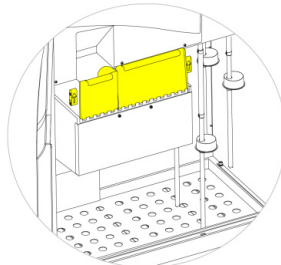

Closing the wax bath doors



F3 highlighted

- You can now move on to load the other reagents into the instrument.
The first of the flush (cleaning) reagents (F3) will be highlighted on the screen ready to be loaded.

Loading Flush Reagents

Flush (cleaning) reagents are used to clean the Reaction Chamber between processing runs and also as part of the reagent loading process. These reagents must be loaded in the following order:

- F3 (water)
- F1 (xylene)
- F2 (alcohol)

For details of approved flush reagents, refer to Appendix D - Approved Reagents on page 181.



Do not use xylene or xylene substitute as the third flush reagent.

Note

Ensure that the colour-coded reagent tubes are fully inserted into the bottles before loading. Excelsior AS uses the manufacturer's five litre reagent bottles in positions F1 and F2 (1 US gallon bottles can also be used).

After removing reagent bottle caps, keep them in a safe place as they will be needed when the reagent is changed.

The flush reagents in the Reagent Storage Area are located in the following positions:

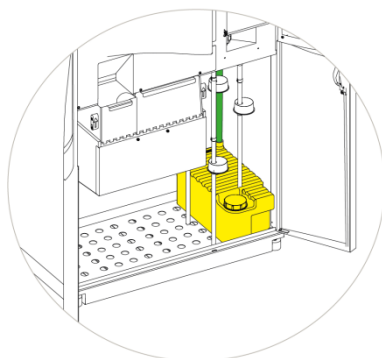

F3 (water)

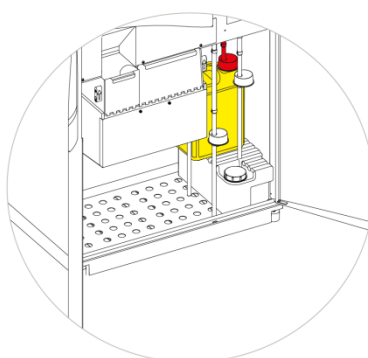

F1 (xylene)

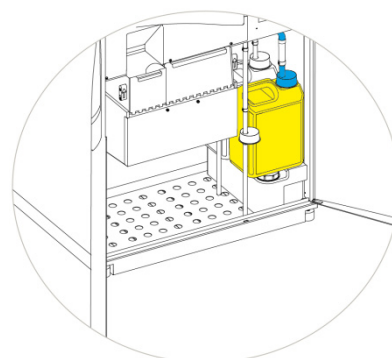

F2 (alcohol)

To load flush reagents:

- Fill the Flush 3 (F3) bottle (supplied with Excelsior AS) with water up to the underside of the fill-line and replace the cap securely.
- Install the F3 bottle in the Reagent Storage Area and put the GREEN reagent tube into the bottle.
- Press **Confirm Loaded** on the Instrument Setup - Load Sequence screen.
F3 is now shown as full and F1 is outlined on the display.
- Take a new five litre bottle of F1 flush reagent (xylene).
- Place the bottle on top of the F3 bottle, and insert the RED reagent tube (with cap).
- Press **Confirm Loaded** on the Instrument Setup - Load Sequence screen.
F1 is now shown as full and F2 is outlined on the display.
- Take a new five litre bottle of F2 flush reagent (alcohol).
- Put the bottle on top of the F3 bottle, in front of bottle F1, and insert the BLUE reagent tube (with cap).
- Press **Confirm Loaded** on the Instrument Setup - Load Sequence screen.

F2 is now shown as full and you are prompted to press Start to prepare the Reaction Chamber so that dehydrant and clearant can be loaded into the concealed bottles at the back of the instrument.

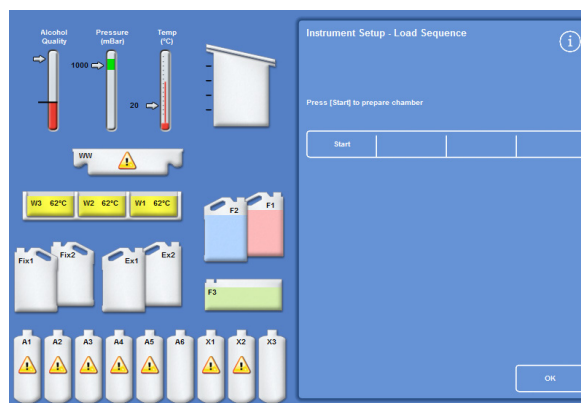

Press Start to prepare chamber

Flushing the Reaction Chamber



The Reaction Chamber must be flushed before dehydrants are loaded into the concealed bottles at the back of the instrument.

To flush the chamber:

- Press **Start**.
The Reaction Chamber is flushed with flush reagent, F2, followed by flush reagent, F3.
When the flush cycle is complete, Ex1 and A1 are highlighted on the display.

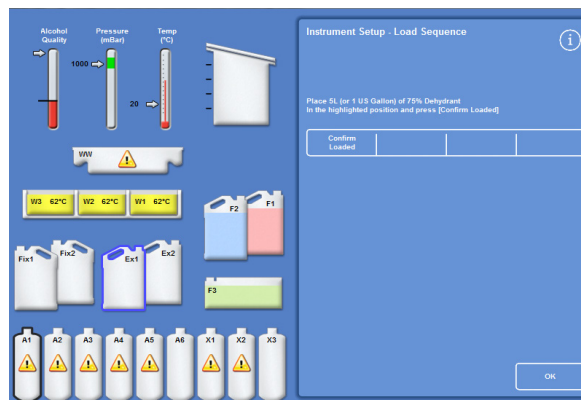

Flush cycle complete, Ex1 and A1 highlighted

Loading Dehydrants

The next step in the Load Sequence is to load the dehydrants into the concealed bottles at the back of the instrument. Various concentrations of dehydrant reagent are required.

Loading dehydrants comprises these steps:

- Place a 5 litre bottle with dehydrant at a specific concentration in the Ex1 position.
- Transfer the dehydrant reagent from Ex1 into the Reaction Chamber and then into the appropriate concealed bottle at the back of the instrument.

To load dehydrants:

- Fill a 5 litre (or 1 US gallon) reagent bottle with alcohol diluted to 75%.

Note:

The majority of under-fill problems on Excelsior AS can be eliminated by using 5 litre reagent bottles.

- Put the bottle in position Ex1, and insert the BLUE tube (with cap).
- Press **Confirm Loaded** on the Instrument Setup - Load Sequence screen to load the first dehydrant.

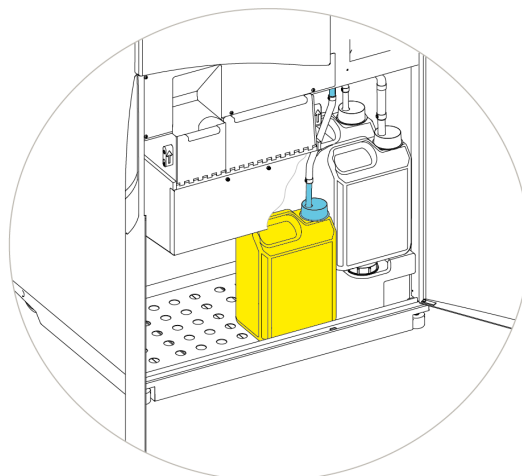

Dehydrant in position Ex1

Note

The instrument will check to see if reagent is already loaded in the concealed bottle.

*If there is reagent present, press **Discard**. Ensure that you place an empty bottle into position Ex1 and press **Unload**. Otherwise, press **Return** to transfer the reagent from the Reaction Chamber into bottle A1.*

- Load the remaining dehydrants. To do this, prepare the following solutions and load them from the Ex1 position into the appropriate concealed bottle. Press **Confirm Loaded** to confirm the correct reagent is in the Ex1 position before loading.
 - A2 = 90% alcohol
 - A3 = 95% alcohol
 - A4–A6 = 100% alcohol

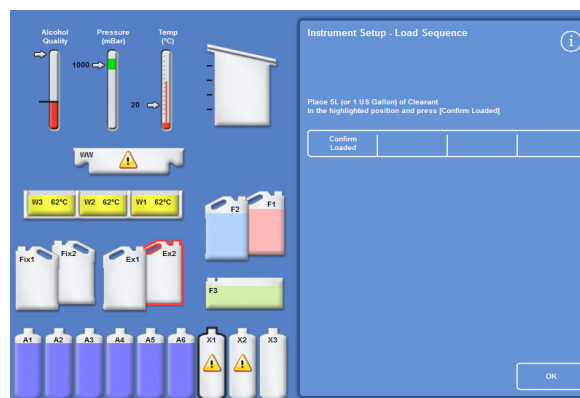

All dehydrants loaded, Ex2 and X1 highlighted

When all of the dehydrants have been loaded, Ex2 and X1 are highlighted on the display.

Loading Clearants

Once the concealed dehydrant bottles have been loaded, you will be prompted to load clearants.

Loading clearants comprises these steps:

- Place a bottle of clearant in the Ex2 position.
- Transfer the reagent from the Ex2 position into the Reaction Chamber and then into the concealed clearant bottles, X1, X2 and X3.

To load clearants:

- Put a 5 litre (or 1 US gallon) bottle of clearant in position Ex2 and insert the RED tube (with cap).

The Ex1 bottle can be removed during this step to make loading easier.

Note:

The majority of under-fill problems on Excelsior AS can be eliminated by using 5 litre reagent bottles.

- Press **Confirm Loaded** on the Instrument Setup - Load Sequence screen to load X1.
- Repeat to load clearant from Ex2 into the concealed bottles, X2 and X3.

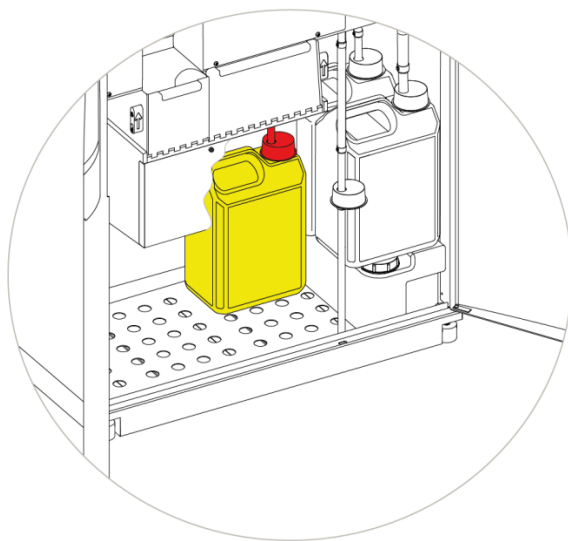

Clearant in position Ex2

Note

The instrument will check to see if reagent is already loaded in the concealed bottle.

*If there is reagent present, press **Discard**. Ensure that you place an empty bottle into position Ex2 and press **Unload**. Otherwise, press **Return** to transfer the reagent from the Reaction Chamber into bottle X1.*

Flushing the Reaction Chamber

When all of the clearants are loaded, you are prompted to start a flush cycle (F2 followed by F3) to prepare the Reaction Chamber for use.

To flush the chamber:

- Press **Start**.

When the flush cycle is finished, the Options - Instrument Setup menu is re-displayed.

- Press **OK** to return to the Options menu and then **OK** again to display the Main Screen.

Excelsior AS is now ready for use.

Note

The following bottles must be left in position for use when reagents are rotated and discarded:

- *An empty bottle in position Ex2, with the RED tube inserted*
- *An empty bottle in position Ex1, with the BLUE tube inserted*

To prevent reagent evaporation, ensure that the coloured caps are in place over the necks of the flush and fixative bottles.

Loading Fixatives

Fixatives in positions Fix1 and Fix2 in the Reagent Storage Area are not loaded as part of the Load Sequence. Instead, the Quality Control screen is displayed when you attempt to start a process for the first time. This screen will prompt for fixatives to be loaded into positions Fix1 and Fix2 (if Fix2 is to be used).

To load fixatives before this screen is automatically displayed, select **Quality Control** from the Main Screen.

Note

You do not have to load two fixative bottles into the instrument. However, the processing programs must be amended to indicate that you are only using one fixative step. See Programs and Flushes on page 111 for more information.

To load fixatives:

- Put fixative bottles in positions Fix1 and Fix2 (if Fix 2 is used).
- Fully insert the GREEN reagent tubes together with the GREEN caps.

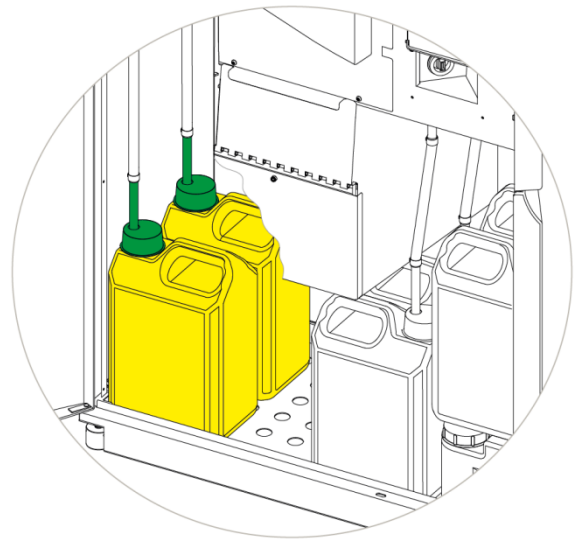

Fixative bottles in position in the Reagent Storage Area

- On the Quality Control screen, press **New**.
- Press **OK** to exit from the screen.



The Quality Control screen

Making Additional Changes Before Processing

Once you have set the time and date and defined and loaded the required reagents, Excelsior AS is ready to process specimens. You may, however, wish to make changes to some of the instrument settings or define your own programs to ensure that Excelsior AS operates to meet your requirements.

Some of the things you may wish to specify or change include:

- Whether a Level option is available – this allows you to fill the chamber to a specific level when processing specimens in Organised baskets.
- The preferred end time for overnight processing programs.
- The triggers for reagent rotation.

Refer to Chapter 4 - Advanced Operation on page 91 for details of the options and settings that can be used to control how Excelsior AS operates and processes specimens.

Chapter 3 – Basic Operation

This chapter describes how to process specimens using Excelsior AS.

This chapter covers the following subjects:

- Loading specimens into the instrument.
- Setting the fill level, if you are using Organised baskets and have enabled the Level button.
- Starting and monitoring a program.
- Adding additional specimens once a program has been started.
- Stopping or aborting a program.
- Completing a program.
- Running a selected program under user-defined conditions.
- Responding to quality control alerts and renewing processing reagents.

Routine Processing

If you are using Excelsior AS to process specimens using the same program each day, then all you need to do is load the specimens into the instrument and start the processing run. The screen that you use to start a program automatically appears when you lift the instrument’s lid to load specimens.

Note

*If this screen has been cancelled, just press **Process** on the Main Screen to re-display it and start processing.*

The routine processing procedure is shown in the following flow chart:

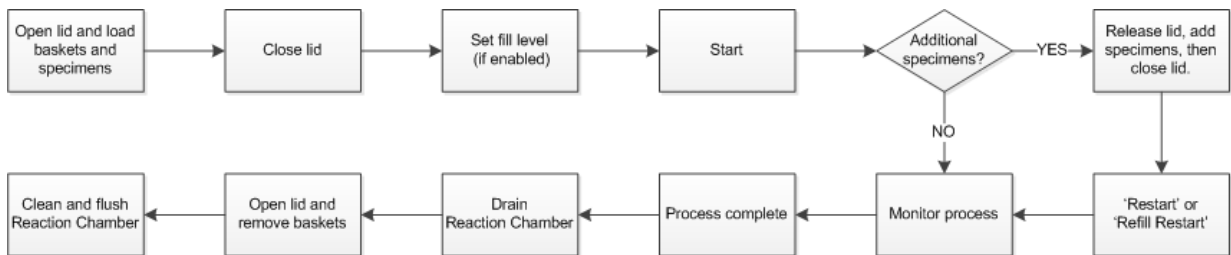

When a run is started, Excelsior AS will automatically begin working through the individual steps so that the program completes at the specified end time. For example, if you are processing overnight, you can load specimens into the instrument at any time during the day and then start the program.

Specimens are held in a specified reagent, usually a fixative, until the start time is reached. Excelsior AS will then process the specimens overnight so that they are ready for the next stage in your tissue processing workflow, the following morning, at the specified end time.

Note

*If you require more flexibility and need to change some of the program parameters for a specific run, refer to **Advanced Processing** on page 72 for details.*



Tissue should only be added during the fixative step.

If circumstances require tissue to be added after fixation, follow good laboratory practice.

Loading Specimens

Excelsior AS allows you to process up to three levels of Organised baskets, arranged in pairs, at any one time. A larger Random basket, which can process up to 300 cassettes, can also be used as an alternative to the smaller Organised baskets.

Note

For details of the baskets that are available to hold specimen cassettes, refer to Appendix A - Accessories on page 174.



Be aware of the samples used. They may pose a biohazard.

Observe Good Laboratory Practice when handling tissue.

Opening the Reaction Chamber:

- Open the Reaction Chamber. To do this, push the handle away from you and lift the lid.

The Reaction Chamber Available screen is automatically displayed:

Note

When the lid is open, fumes are extracted through the downdraft filter behind the Reaction Chamber.

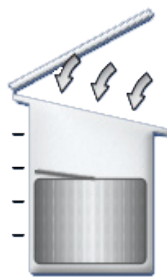

Chamber open, downdraft fan on

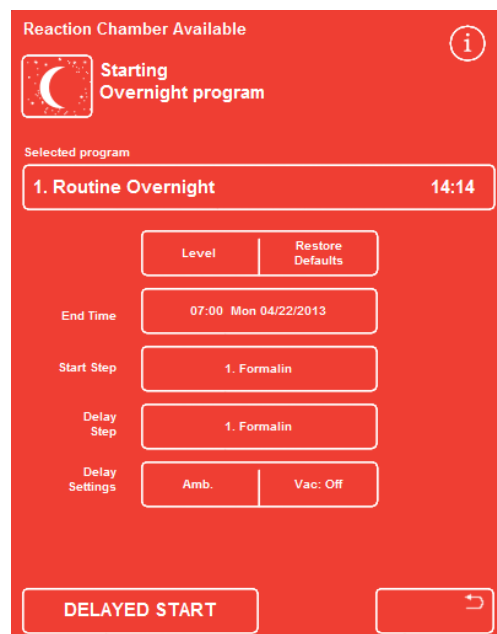

The Reaction Chamber available screen

Loading Cassettes and Baskets:

- Load the cassettes into the Organised basket.
If you are using a Random basket, tissue cassettes should be carefully placed into the basket.

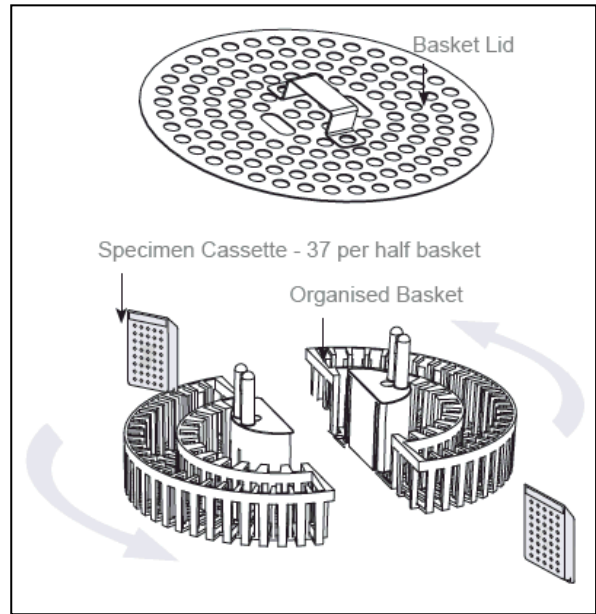

Loading cassettes into an Organised basket

- Load baskets (with a basket-lid) into the chamber, stacked in uniform pairs, and aligned so they sit properly on the agitation drive pins.
- Close the Reaction Chamber lid, pushing down on both sides. Pull the handle towards you to ensure that the lid is correctly latched.

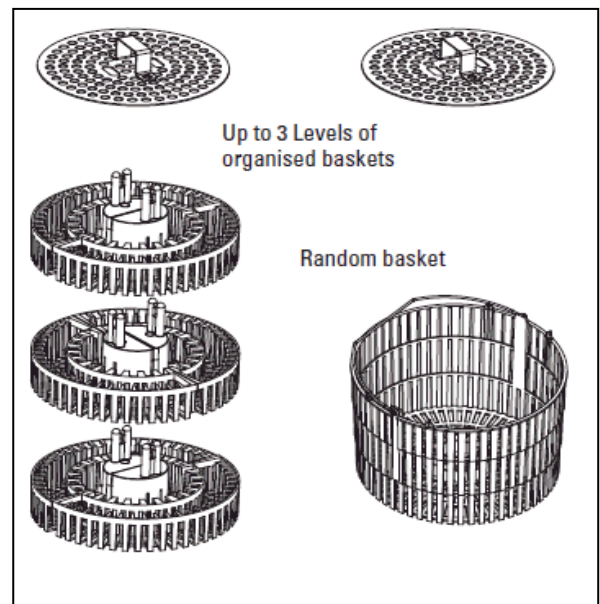

Organised and Random baskets

Setting the Fill Level

Depending on how Excelsior AS has been configured (see Customising Your Instrument on page 107), a Level button may be displayed on the Reaction Chamber Available screen. Use this button to select the appropriate fluid level to cover the specimen baskets that have been added to the Reaction Chamber.

Note

To prevent under-filling within the Reaction Chamber, select a fluid level that corresponds with the number of baskets added.

If too many levels of baskets are shown, press **Level** until the correct number is displayed.

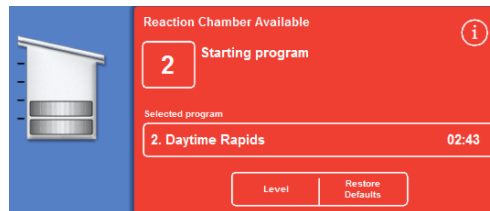

Using the Level button; two levels of baskets have been selected

Note

If the Level function has been disabled or you do not set a specific fill level, Excelsior AS assumes a Random basket has been loaded and fills the Reaction Chamber to the highest level.

Starting a Program

A program can be started when specimens and baskets are loaded and the fill level has been set (if applicable). The program will either start immediately or after a delay in fixative or alcohol. The length of the delay will vary according to the specified end time of the program.

Programs are started from the Reaction Chamber Available screen which is displayed when you open the lid to load samples. If this screen is not displayed, press **Process** on the Main Screen.

Note

You can add more sample cassettes or levels of Organised baskets once a process has been started. See Adding Specimens on page 64 for details.

For details of the default process and flush programs installed on Excelsior AS, see Appendix E - Program Examples on page 182.

To start a program:

- Ensure that the selected program is correct.
- Check that the displayed End Time and Start Step are correct.
- If the program uses a delayed start, ensure that the Delay Settings and Delay Step are correct.
- Press **IMMEDIATE START** or **DELAYED START** to start the program.

Note

*If you press the back button, rather than the start button, press **Process** on the Main Screen to re-display the Reaction Chamber Available screen and start processing.*

Pressing the back button will lose any changes made to the End Time, Start Step, Delay Step and Delay Settings.

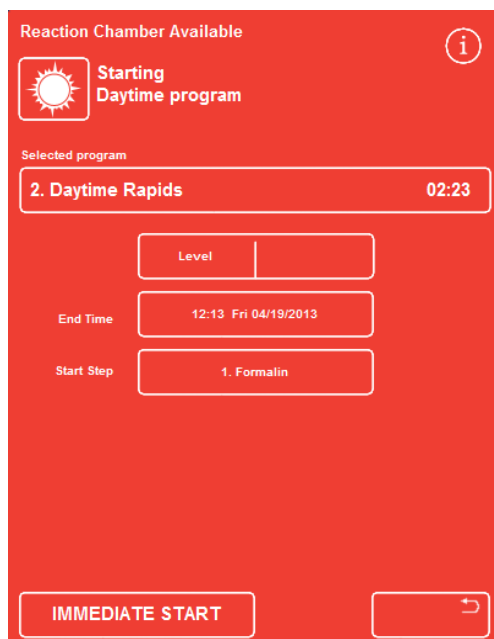

Immediate Start

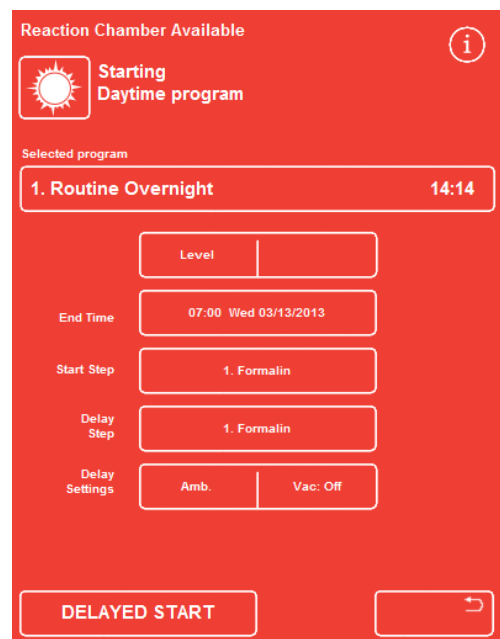

Delayed Start

- Details of the status of the program, such as the current step and time remaining until completion, are displayed on the Monitoring screen which updates as the program moves through its defined steps.

For additional information, see Monitoring a Program on page 62.

- If you are running an overnight program with a delayed start, the Reaction Chamber will fill with the delay step reagent and then hold until active processing starts to complete at the specified end time.

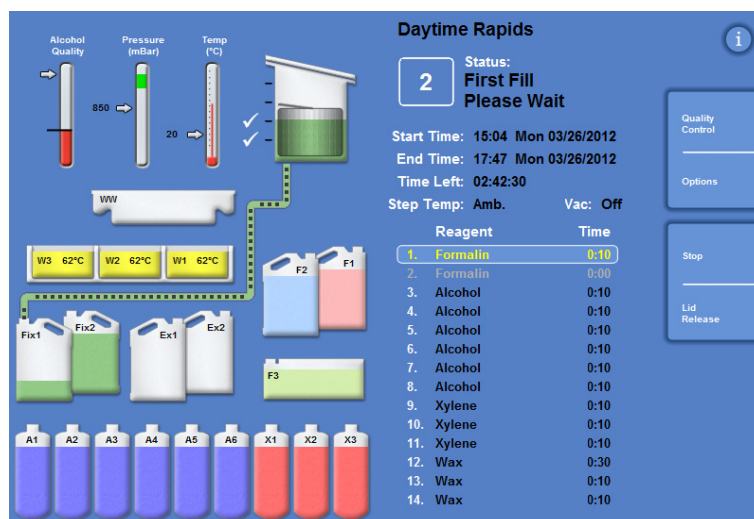

The Monitoring screen

Quality Control Checks

If the Quality Control screen appears automatically when you press the **IMMEDIATE START** or **DELAYED START** button, this means a usage limit for a reagent, wax or filter has been reached.

The program will not start until all issues shown on the Quality Control screen have been resolved. For more information on renewing reagents, wax and filters, refer to Quality Control, Filter and Reagent Renewal Limits on page 78.

Instrument Faults

A program may fail to start if there are faults with the instrument. These will be listed on the Fault Status screen, which is automatically displayed when faults exist and a program is started. The wrench (spanner) icon will also appear at the bottom of the Main Screen.

For more information on how to respond when the Fault Status screen appears, refer to Using the Fault Status Screen on page 158.

Monitoring a Program

The progress of a running program can be viewed on the Monitoring screen. It displays a series of defined steps with the current program status, step position and reagent all indicated.

As the program progresses, the highlighted position moves down through the defined steps. Any steps that have been disabled are shown greyed out on the list.

Fluid transfer between the reagent containers and the Reaction Chamber is indicated by an animated connecting pipe.

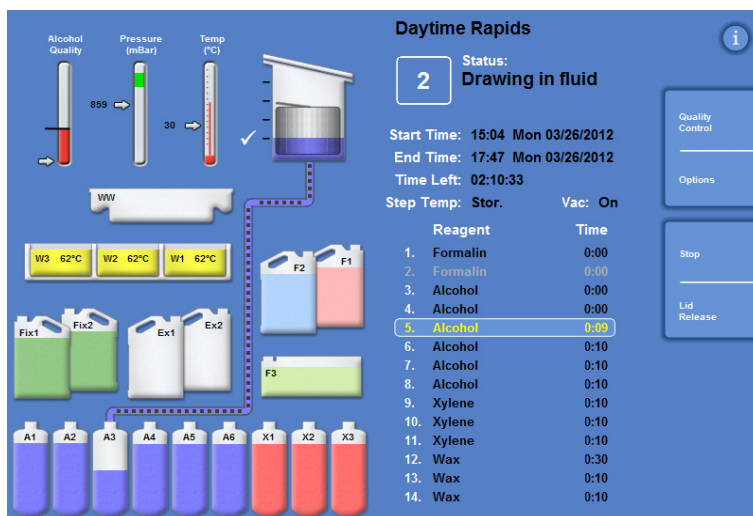

Following the progress of a program

The Monitoring screen shows the following information:

Item	Description
Status	Shows the status of the current processing operation: Lid Check Please Wait: The instrument is checking that the lid is closed. Valve Indexing: The instrument is checking the position of the valve. First Fill – Please Wait: The instrument is filling with the first reagent. Drawing in fluid: The Reaction Chamber is being filled with reagent. Processing: The highlighted step is currently running. Draining: The Reaction Chamber is draining. Stopped: The process has been stopped using the Stop button. Aborting process: The process has been stopped and then aborted using the Abort button. Waiting for wax: The wax has not reached the correct temperature. Process complete: The program has completed. Lid released: The Reaction Chamber lid is released and can be opened.
Start Time	The time (and date) that the program was started.
End Time	The time (and date) that the program will end. Immediate Start: Based on the total time and the start time. Delayed Start: The preferred end time. See Setting the Workflow Processing Options on page 109.
Time Left	The time remaining before the program completes.

Item	Description
Time	<p>The time for each step in the selected program. If the start is delayed, the time in the delay reagent will be adjusted to ensure that the program completes at the specified end time.</p> <p>When a step is currently highlighted and running, the time value indicates the time left before the step completes.</p> <p>When a step has completed, the time displays as 0:00.</p>
Delay/Step Temp	<p>The usage temperature for the program or flush step. This can be different from the storage temperature.</p> <p>Note</p> <p><i>Reagents cannot be cooled.</i></p>
Vac	<p>The vacuum conditions in the Reaction Chamber during each step.</p> <p>Three settings can be indicated:</p> <p>On: Specimens are held at atmospheric pressure.</p> <p>Off: Specimens are held at approximately 650 mbar absolute (350 mbar below atmospheric pressure).</p> <p>Cycle: Specimens are held in a increasing/decreasing, 15 minute, pressure cycle that ranges from approximately 650 mbar absolute (vacuum conditions) through to atmospheric pressure.</p>

Adding Specimens

Additional tissue cassettes or Organised baskets can be added after a program has started.



Tissue should only be added during the fixative step.

If circumstances require tissue to be added after fixation, follow good laboratory practice.

Note

To minimise the escape of reagent vapours from the Reaction Chamber when it is open, always press the **Lid Release** button before opening the lid. This will start the downdraft fan which draws reagent vapours away from the Reaction Chamber.

It is not possible to open the lid if the Reaction Chamber is under vacuum; check the Pressure Gauge is in the green range before attempting to open the lid.

To add additional specimens or baskets:

- Press **Lid Release**.
Wait for the downdraft fan to start and for the vacuum to release (if the step uses vacuum).
- Open the lid.
The Processing screen is displayed.
- Add cassettes or baskets, and then close the lid.

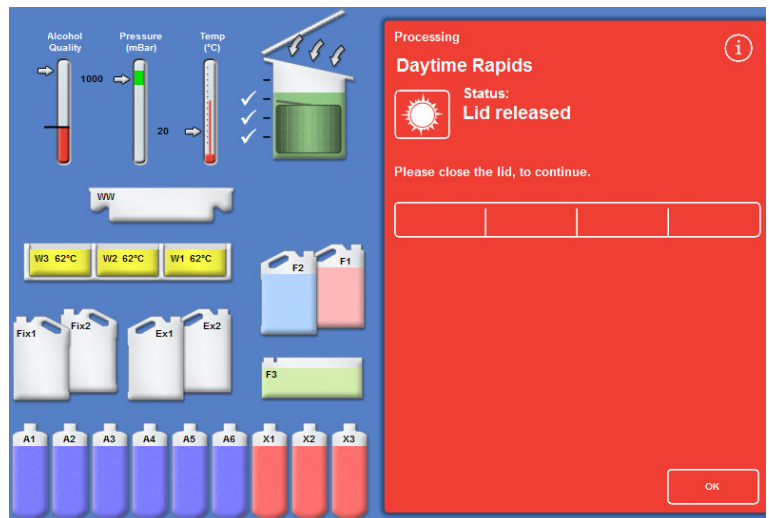

Lid released and opened, the Processing screen is displayed

Note

If you forget to restart the program, the On Hold Alarm will sound after the specified elapsed time.

For more information about the alarms that can be set, see *Using Audio and Remote Alarms* on page 130.

- If you do not add more baskets to the Reaction Chamber, or you are using a Random basket, press **Restart** or **Refill and Restart**.

This will allow processing to continue to the original fill level.

- If you add additional baskets (or remove baskets) and the level function is enabled, press **Level**.

The basket level shown on the screen will then correspond with the number of baskets in the chamber.



Lid closed, ready to restart processing

Note

If you have removed baskets and have reduced the level correspondingly, the level of the liquid in the chamber will not change until the next fill.

- To restart a processing step, press **Restart** or **Refill and Restart**.

Stopping a Process

If required, a program can be stopped. When processing has stopped, different buttons appear on the right of the Monitoring screen allowing you to:

- Drain the Reaction Chamber.
- Restart the step (if the step was stopped when the status was 'Processing').
The chamber will not be refilled with the selected reagent before the step is restarted.
- Refill and restart from the selected step (if the step was stopped when the status was 'First Fill - Wait' or 'Drawing in fluid' or the chamber was drained).
The chamber will be refilled with the selected reagent before the step is restarted.
- Abort the entire program (for more information, see [Aborting a Program](#) on page 67).

Note

You cannot stop a program when the status is shown as 'Draining'. Only actively running programs can be stopped. If a program that is in a delay step is stopped, the time remaining will continue to decrease, however the program will not progress any further.

To stop a program:

- Press the **Stop** button.
The Status changes to 'Stopped' and the following buttons appear under the Quality Control and Options buttons:
 - **Drain Next Level**
 - **Drain All**
 - **Restart** or **Refill Restart**
 - **Abort**

To drain the chamber:

- Press the **Drain Next Level** button to drain a single level or the **Drain All** button to empty the chamber.
The instrument checks the status of the lid and then drains fluid from the chamber. To stop the draining process, press the **Stop Drain** button when it appears.

Note

*To continue processing, refill the chamber and restart the step using the **Refill Restart** button. The instrument checks the status of the lid, draws in fluid to the defined level, and then resumes processing if the lid is closed.*

To restart a processing step:

- Press the **Restart** button.
The instrument checks the status of the lid and then resumes processing if the lid is closed.

Aborting a Program

If a program has been started in error, it can be stopped and then aborted.

To abort a program:

- From the Monitoring screen, press **Stop** to stop the active program.
- Press **Abort**.

After checking the lid, the status is shown as 'Aborting process'; the program is aborted, the Reaction Chamber is drained and the Main Screen appears.

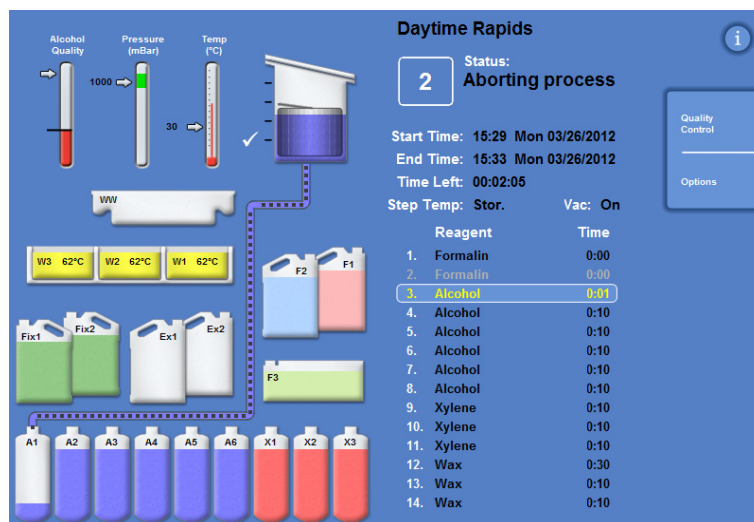

Aborting process

Completing a Program

When processing has completed, the Process Complete screen is displayed.

You must then:

- Drain the Reaction Chamber and remove the baskets.
- Wipe away excess wax from the Reaction Chamber, lid and seal and flush the Reaction Chamber.

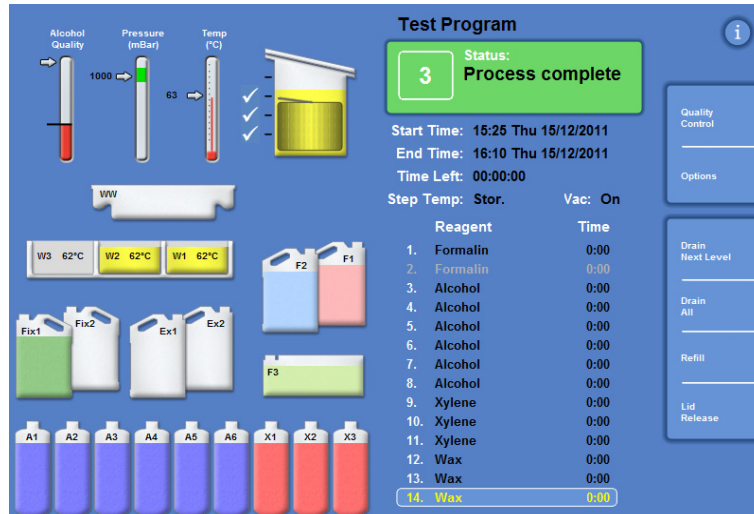

The process is complete



Be careful, baskets may be hot when you remove them from the Reaction Chamber.



Avoid spilling residual reagent or wax onto the instrument's surface or onto the floor when removing baskets from the Reaction Chamber.

Draining the Reaction Chamber

The Reaction Chamber can be drained one level at a time or drained completely in one step.

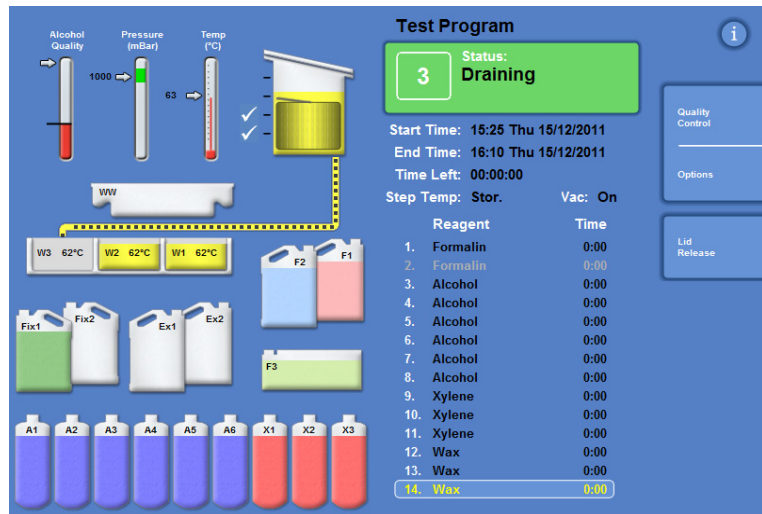

The Draining Screen

To drain the chamber one level at a time:

- Press **Drain Next Level**.
Wait until draining stops.
- Press **Lid Release**.
- Open the lid and remove the first level of baskets.
The red Process Complete screen appears.
- Close the lid.
- Drain the remaining levels one at a time, removing baskets at each level, until the chamber is empty.

To drain the chamber in one step:

- Press **Drain All**.
Wait until draining stops and the red Process Complete screen appears.
- Press **Lid Release**.
- Open the lid and remove the baskets.

Note

If the Level Key is enabled, press **Level** to update the display to show the number of baskets remaining in the chamber.

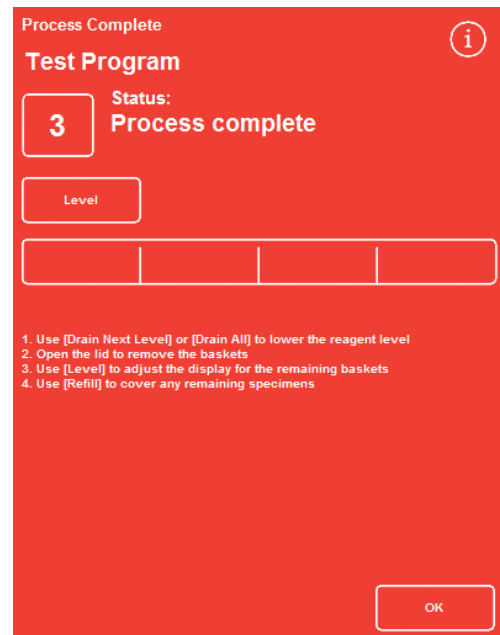

Process Complete

Cleaning the Reaction Chamber

Use clean, dry absorbent paper to wipe the Reaction Chamber after each processing run. This should be done before the flush cycle is started.

Note

Flush reagents will clean more effectively if residual wax is removed from the chamber and baskets before a flush is carried out.

To clean the Reaction Chamber:



The lid seal and top surface of the Reaction Chamber must be kept clear of wax for the instrument to operate correctly.

The lid seal cannot be removed for cleaning. Do not try to remove it.

- Open the lid and use the plastic spatula provided to remove any solidified wax from the lid, top and sides of the Reaction Chamber.
- If necessary, wipe the surfaces of the Reaction Chamber with absorbent paper.
- Use absorbent paper to gently wipe the four level sensors in the Reaction Chamber.

Cleaning recommendations

During cleaning, observe the following recommendations to avoid damaging the instrument:

- Do not use abrasive cleaners other than those provided with the instrument.
- Do not use metal tools to clean or scrape the Reaction Chamber.
- Do not use any chemicals other than those recommended in Appendix D - Approved Reagents on page 181.
- Do not scrape around the edge of the Reaction Chamber base. If any debris falls into this gap, carefully use forceps to remove it.

Flushing the Reaction Chamber

The Drain Complete screen

When there are no more baskets in the Reaction Chamber and the reagent has been drained, the Drain Complete screen is displayed.

This screen prompts you to wipe the Reaction Chamber and level sensors and then flush the Reaction Chamber before starting the next process.

It is important to wipe the Reaction Chamber with clean, dry absorbent paper after every flush and to check for any contamination. Evidence of wax may indicate that the flush reagents need to be changed.

Note

If you do not flush the chamber you will not be able to start a new process run. Ensure that you flush the chamber between processing runs.

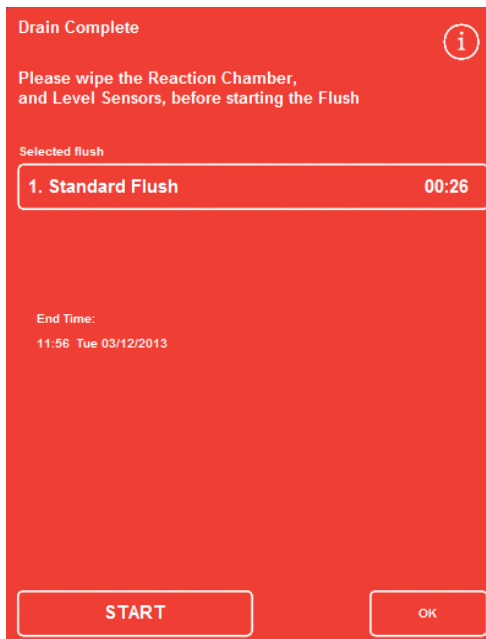

The Drain Complete screen

To flush the chamber:

- To run a different flush program to the one automatically selected, press on the name of the selected flush and choose the one that you want to run from the list.

Note

After wax has been used, the instrument will make you run a standard or extended flush; it is not possible to set up a shorter flush.

- Press **START** to start the selected flush program.

The progress of the flush program is displayed on the Monitoring screen. Once the flush has completed, the Flush Complete screen is displayed.

- Press **OK**.

The instrument is now ready to process the next batch of specimens.

Note

An 'Extended Flush' should be run in the following situations:

- *The first flush after the flush reagents have been renewed.*
- *If a xylene substitute reagent is used.*

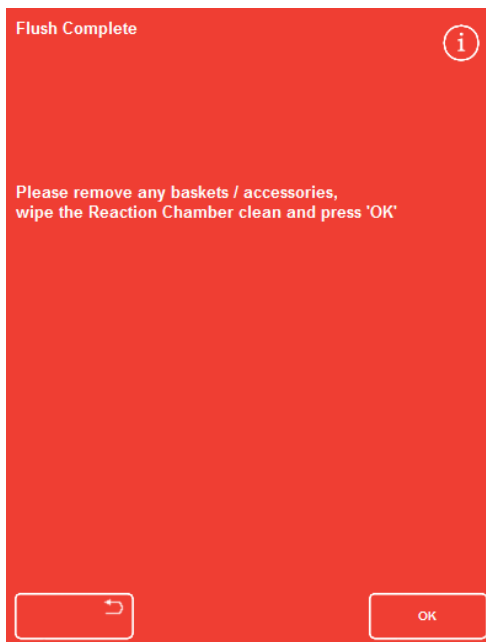

The Flush Complete screen

Flushing the Instrument

A separate flush function is available that can be used to run flush cycles outside of routine processing, as required.



If the Process button is not displayed on the Main Screen, you must run a flush program using the Flush button before you can start a new processing run.

To flush the instrument:

- From the Main Screen, press **Flush**.
- To run a different flush program to the one automatically selected, press on the name of the selected flush and choose the one that you want to run.
- Press **START** to start the selected flush program.

Advanced Processing

If you are running specimens through a specified program on a routine basis, there is no need to change any of the program parameters.

If you require more flexibility, use the Reaction Chamber Available screen before processing your specimens. From here you can select a different program, change the end time, starting step or delay settings.

Note

Any changes that you make to the parameters for a selected program apply only to the current processing run and are not saved.

Selecting a Program

Excelsior AS can be configured to automatically select a default program on opening of the reaction chamber lid. The program can be different depending on the time of day (see Setting the Workflow Processing Options on page 109). Other programs can be selected, as required.

Note

If no default programs are defined (for example, within research laboratories), the Select a Program screen is displayed when the lid is opened. This allows operators to choose the required program by pressing the appropriate program button.

To change the currently selected program:

- On the Reaction Chamber Available screen, press **Selected program**:

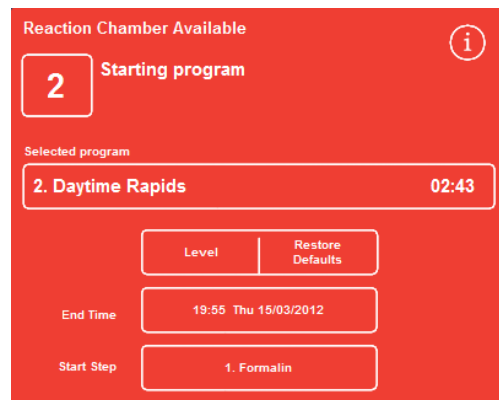

Changing the selected program

A list of available programs is displayed on the Select a Program screen:

The currently selected program is shown in yellow.

The default overnight program is identified with the 'night' icon.

- Select the program you want to run and then press **OK**.

The selected program is displayed on the Reaction Chamber Available screen.

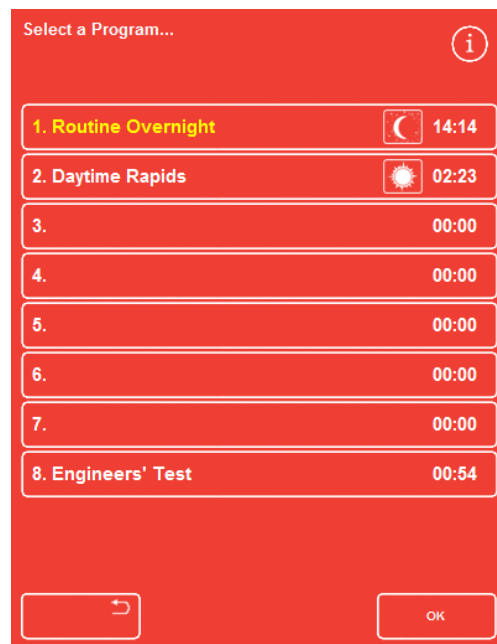

The Select a Program screen

Changing Program Parameters

Once you have selected the required program and adjusted the fill level (if applicable), you can either start the program or make changes to some of the available parameters before doing so.

Note

If you make any changes to the default parameters for a selected program, a warning symbol appears next to the changed parameter. This is for information purposes only and the program will still run when it is started.

- To reset the parameters back to the default values, press **Restore Defaults**.

Note

The Restore Defaults button only appears if changes have been made.

The Level button will only appear if the Level Key function has been enabled. For more details, see Customising Your Instrument on page 107.

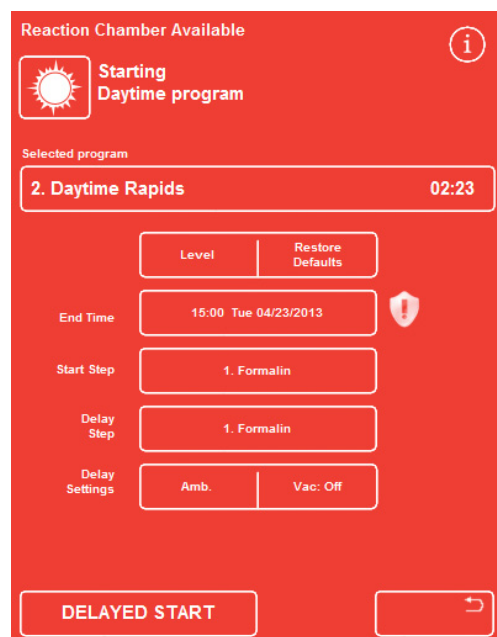

End Time has been changed - Restore Defaults button is enabled

Adjusting the End Time

The end time for a program can be changed to a different time or day, as required. The start time will then adjust so the program ends at the specified end time. The program can also be set to start immediately with no delay.

Note

When the end time for a daytime program is changed, the start will be delayed. Delay settings and delay step can then be specified. If a program cannot complete at an end time in the current day, it will move forward to the next day.

To adjust the program end time:

- On the Reaction Chamber Available screen, press the program's **End Time**.

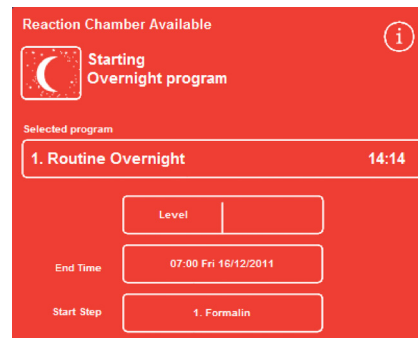

Changing the end time for the program

The Reaction Chamber Available - Set End Time screen is displayed:

- Use the number pad to set the required end time.
- If the system clock is in 12-hour mode, press **am/pm**, as required.
- To move the end time back or forward by 24 hours, press **Previous Day** or **Next Day**, respectively.

Note

*You should not normally need to move the time forward if the working week is defined correctly (see [Setting the Workflow Processing Options](#) on page 109 for more information). However, if the selected day is a holiday, you may need to use the **Next Day** button.*

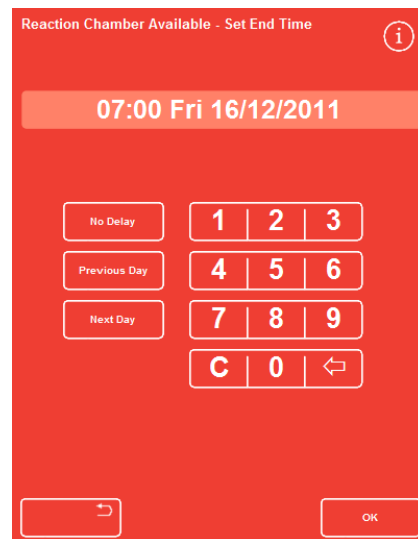

The Reaction Chamber Available - Set End Time screen

- Press **OK** to save the changes.
- Start the selected program by pressing **DELAYED START** or **IMMEDIATE START**.

Note

*If you want the program to start immediately, select **No Delay** on the Reaction Chamber Available - Set End Time screen. Remember that if you do this, the program may complete when the instrument is unattended.*

Changing the Start Step

If required, the starting step for the selected program can be changed. You may want to do this if you are transferring specimens from another instrument.

To change the first step in the program:

- On the Reaction Chamber Available screen, press the **Start Step** button until the required step in the program is selected.

A warning symbol is displayed, indicating that you have made a change to the default start step for the selected program.

The reagents in use remain highlighted:

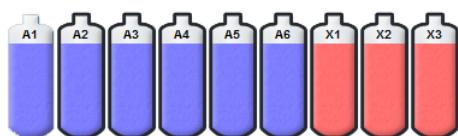

Reagents in use are highlighted

- To change the start step back to its original setting, press **Restore Defaults**.
- Start the selected program by pressing **IMMEDIATE START**.

Note

All step start programs are immediate start programs.

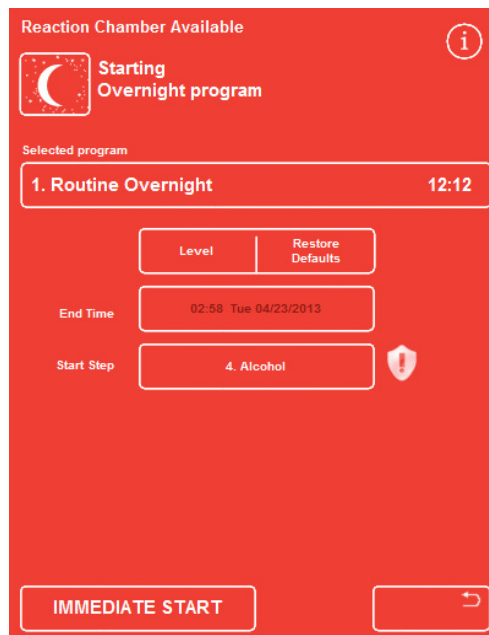

Changing the start step

Changing the Delay Settings

By default, the delay settings will hold specimens in the Reaction Chamber at ambient temperature with no vacuum. These conditions can be changed, as required.

Note

*The delay temperature can be set at 1-55°C and ambient.
The instrument will not cool reagents below ambient conditions.*

To change the delay temperature:

- On the Reaction Chamber Available screen, press the displayed **Delay Settings** temperature setting:

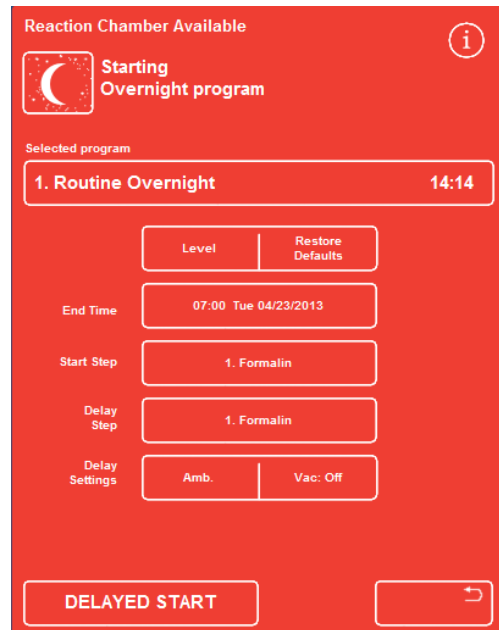

Changing the delay temperature

The Reaction Chamber Available - Set Delay Temperature screen is displayed:

- Use the number pad to set the required temperature. Alternatively, press **Amb** to hold the delay reagent at ambient temperature.
- Press **OK** to save the changes.

A warning symbol is displayed, indicating that you have made a change to the default delay temperature. To change the temperature back to its original setting, press **Restore Defaults**.

- Start the selected program by pressing **DELAYED START**.

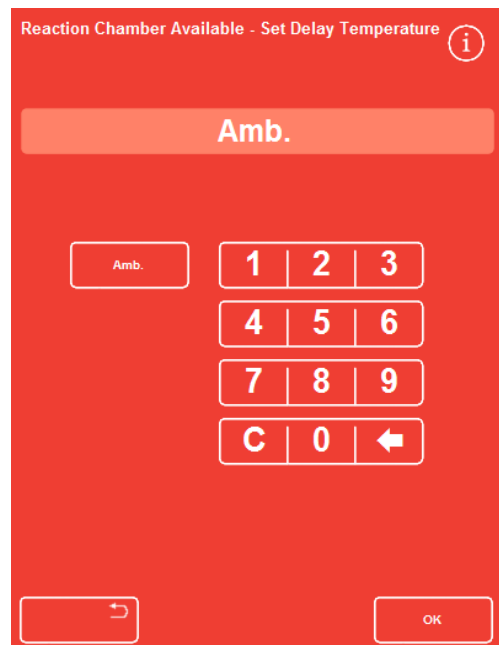

The Reaction Chamber Available - Set Delay Temperature screen

To change the delay vacuum setting:

- On the Reaction Chamber Available screen, press the displayed vacuum setting (Vac) until the required setting is selected.
- You can choose from:
 - Vac: Off:** Specimens are held at atmospheric pressure.
 - Vac: On:** Specimens are held at approximately 650 mbar absolute (350 mbar below atmospheric pressure).
 - Vac: Cycle:** Specimens are held in a increasing/decreasing, 15 minute, pressure cycle that ranges from approximately 650 mbar absolute (vacuum conditions) through to atmospheric pressure.
- A warning symbol is displayed if you change the setting. To change the delay pressure back to its original setting, press **Restore Defaults**.

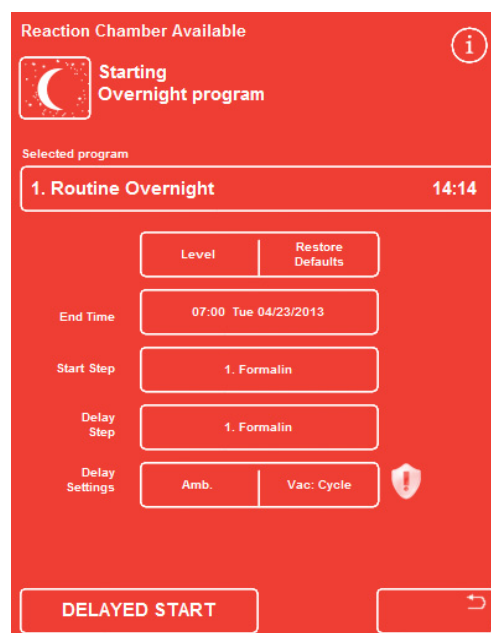
*Changing the delay vacuum setting*

- Start the selected program by pressing **DELAYED START**.

Changing the Delay Step

The delay step specifies the reagent in which loaded specimens will be held before the program starts. This will default to the first step. For programs containing a fixative step the delay step can be changed to occur as part of the first alcohol step. This may be because the tissue specimens are pre-fixed or delicate.

To change the delay step:

- Press the appropriate button on the Reaction Chamber Available screen to select the reagent for the delay step.
- The selected delay step is shown and can be either the first fixative step in the program or the first alcohol step.
- A warning symbol is displayed if you change the step.

Note

If the delay step is changed to the first alcohol step, the temperature and vacuum settings used during the delay will be the same as those used within the alcohol step.

- To change the delay step back to its original setting, press **Restore Defaults**.
- Start the selected program by pressing **DELAYED START**.

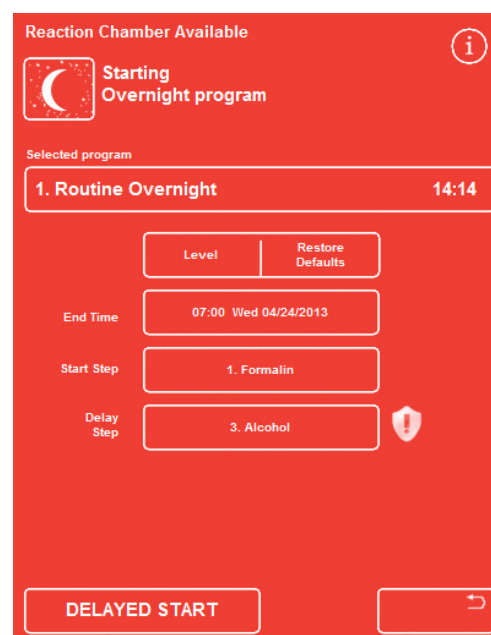
*The delay step - changed from the default*

Quality Control, Filter and Reagent Renewal Limits

When filters or reagents need to be changed, the Quality Control screen will appear when a processing run is started. The screen allows you to do the following:

- See how many weeks of use each filter has had and whether it is due to be replaced.
- Reset the usage value for a filter after it has been replaced.
- See which reagents are due to be rotated.
- Acknowledge prompts to discard or rotate reagents.
- Postpone wax discard or reagent rotation.

A yellow alert triangle is also displayed at the bottom of the screen. Any Quality Control alerts must be acknowledged or postponed to allow processing to start.

Note

*You can check the status of the instrument's reagents and filters at any time by selecting the **Quality Control** option from the Main Screen.*

Filter and Reagent Usage Information

Usage information is displayed over icons representing the Downdraft, Fixative and Charcoal replaceable filters and reagent bottles. The use limit count is displayed in weeks for the filters and number of times used for reagents. These limits can be set on the Use Limits screen (see Setting Use Limits on page 42 for details).

For additional information about swapping filters, refer to Fitting the Filters on page 29 and Reagent, Wax and Filter Checks on page 92.

Note

The recommended use limit for the filters is 13 weeks. This is set as the system default.

Examples:

The following symbols can be displayed over the filter icons:



The number indicates that the filter has been in use for seven weeks.

The colour green indicates that the filter is within the use limit period, defined on the Use Limit screen.



The number indicates that the filter has been in use for 12 weeks.

The colour yellow indicates that the filter should be replaced within one week.



The number indicates that the filter has been in use for 13 weeks.

The colour red and the warning triangle indicate that the defined usage limit has been reached.

Wax Discard and Reagent Rotation Information

The limits for wax discard and concealed reagent rotation are set on the Rotation Management screen (see Triggers for Reagent Rotation on page 101 for details). Rotation triggers can be based on the following:

- A1 alcohol quality (recommended)
- Use limits
- Days of the week

Rotation information is displayed on the Quality Control screen. The information is based on the defined triggers and limits and informs which reagents are due to be discarded or rotated and when the discard or rotation will occur.

Use limits can be set on the Use Limits screen (see Setting Use Limits on page 42 for details).

Note

The limit is based on counts only for Fix1, Fix2, F1, F2, and F3.

The screenshot shows the 'Quality Control' interface. At the top, there are navigation tabs: 'Inspect Reagents', 'Detailed Information', 'Reports', and an information icon. Below these is a 'Remove' button. The main content area is divided into three sections: 'Alcohol', 'Xylene', and 'Wax'. Each section contains a status bar indicating the next action: 'Will not rotate next run' for Alcohol and Xylene, and 'Will not discard next run' for Wax. An 'OK' button is located at the bottom right of the screen.

Quality Control – alcohol, xylene and wax rotation and discard information

Renewing Fixative Reagents

If a yellow warning triangle alert appears inside the fixative reagent bottles on the Main screen and Information Bar, change the reagents before running the next process.



Dispose of the used fixatives in accordance with local procedures and regulations.

To change fixatives:

- Open the main doors of the instrument.
The Quality Control screen appears.
- Take out the Fix1 and Fix2 bottles (if used) from the Reagent Storage Area. Replace the caps on the bottles and set the bottles aside for disposal.
- Press the **Fix1** image on the Quality Control screen to select it.
The Fix1 bottle is outlined in black.
- Press **Remove** on the Quality Control menu.



Removing Fix1 – Quality Control Screen

The Fix1 bottle image changes to empty with a warning triangle displayed within it.



Renewing Fix1 – Quality Control Screen

- If you are using two fixative steps, press the **Fix2** image on the Quality Control screen and press **Remove** on the Quality Control menu.
The Fix 2 bottle image changes to empty with a warning triangle displayed within it.
- Clean the fixative reagent dip tubes. See *Cleaning the Reagent Supply Bottle Dip Tubes* on page 147.
- Put new 5 litre (or 1 US gallon) bottles of fixative in positions Fix1 and Fix2 (if used) inside the Reagent Storage Area and fully insert the bottle dip tubes.

Note:

The majority of under-fill problems on Excelsior AS can be eliminated by using 5 litre reagent bottles.

- Press the **Fix1** image on the Quality Control screen and press **New** on the Quality Control menu.
The warning triangle inside the image of Fix1 disappears.
- If you are using a second fixative, press the Fix2 image on the Quality Control screen and press **New** on the Quality Control menu.
The warning triangle inside the image of Fix2 disappears.
- Press **OK** to close the Quality Control screen.
- When you have finished replacing the fixative reagents, close the main doors.

Renewing Flush Reagents

If a yellow warning triangle alert appears inside the flush reagent bottles on the Quality Control screen, change the reagents before running the next flush cycle.



Dispose of the used flush reagents in accordance with local procedures and regulations.

To renew flush reagents:

- Open the main doors and remove the flush reagent bottles from the Reagent Storage Area.
- Remove F2 first followed by F1 and then F3. Replace the caps on the F1 and F2 bottles and set the bottles aside for disposal.
- Press the **F2 image** on the Quality Control screen to select it.

The bottle is outlined in black.

- Press **Remove** on the Quality Control menu.

The F2 bottle image changes to empty.

Note

If the reagent use limits have not been reached, a warning triangle will appear on the bottle and the Information Bar when Remove is pressed. The warning triangle will already be present if the reagent has reached its use limit.



Removing a reagent – Quality Control Screen

- Repeat for F1 and F3.
- Clean the reagent dip tubes and clean and refill the F3 water flush bottle.

For instructions, refer to Cleaning the Reagent Supply Bottle Dip Tubes on page 147 and Cleaning the Flush 3 Water Bottle on page 148.

- Put the F3 bottle back into the instrument and place new five litre bottles of F1 and F2 flush reagent in position, on top of the F3 bottle.
- Insert the reagent dip tubes in each bottle.

- Select each flush reagent in turn on the Quality Control screen and press **New**.
- Press **OK** to close the Quality Control screen.
- If all reagents have been replaced, close the main doors.



Registering new reagents – Quality Control Screen

Renewing Dehydrants, Clearants and Infiltrants Using Rotation

The Quality Control screen is displayed automatically at the beginning of a process run if dehydrants, clearants or infiltrants (wax) need to be renewed.

Alcohol Quality Warning

If alcohol quality in bottle A1 has reached the trigger for rotation, a triangle is displayed above the Alcohol Quality gauge on the Main Screen:



The Alcohol Quality gauge indicates rotation due

In-process Reagent Rotation

Excelsior AS uses an in-process system of reagent rotation for managing the renewal of dehydrants, clearants and infiltrants across twelve containers, using one rotation procedure. This process operates in the following way:

- The used reagent from the appropriate containers (used for the first steps in these processing groups) is discarded into the exchange bottles or waste wax tray.
- The rest of the reagents are rotated (A2 becomes A1, A3 becomes A2, and so on.)
- The last container in each group (A6, X3 and W3) is left empty ready for fresh reagents to be loaded.

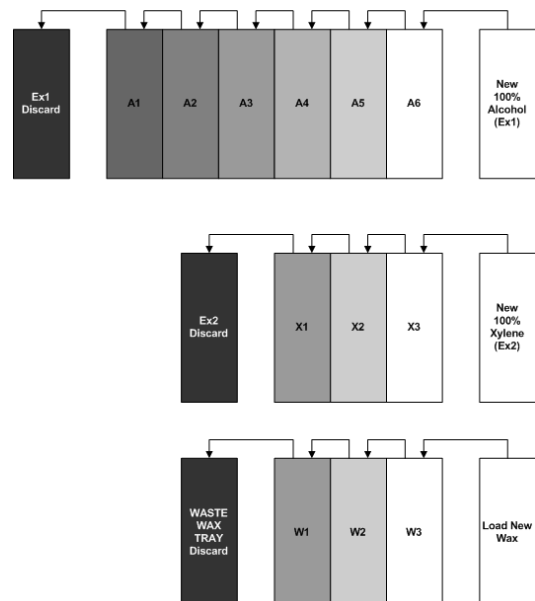

Reagent rotation and wax discard

To rotate a dehydrant:

- On the Quality Control screen, press **Rotation due next run** to select the group of reagent bottles which are due to rotate.

Notice that the bottles are highlighted in black.

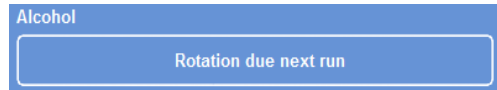

Select the reagent to be rotated

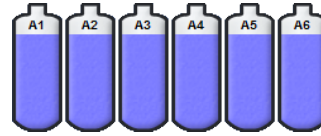

Highlighted reagent bottles

- From the Quality Control menu, press **Acknowledge**.



Acknowledging the reagent rotation request

'Rotation due next run' changes to 'Will rotate next run':

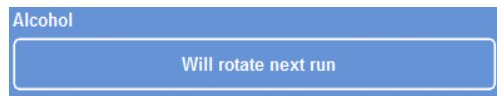

Alcohol will rotate on the next run

To rotate a clearant:

- Press **Rotation due next run** to select the group of reagent bottles which are due to rotate.

Notice that the bottles are highlighted in black.

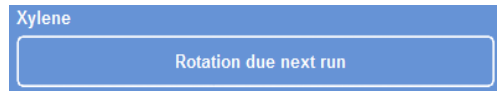

Select the reagent to be rotated

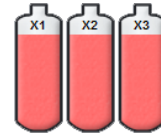

Highlighted reagent bottles

- From the Quality Control menu, press **Acknowledge**.

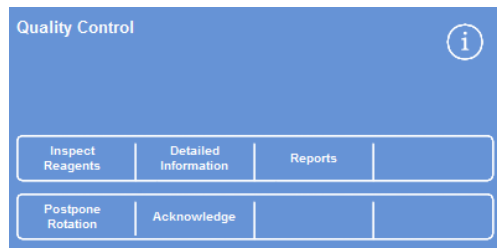

Acknowledging the reagent rotation request

'Rotation due next run' changes to 'Will rotate next run':

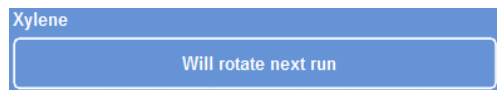

Xylene will rotate on the next run

To discard wax:

- Press **Discard due next run** to select the wax baths.

Notice that the baths are highlighted in black.

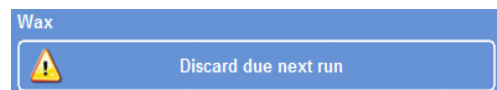

Selecting the wax baths

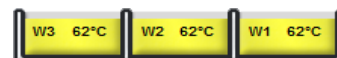

Highlighted wax baths

- From the Quality Control menu, press **Acknowledge**.

'Discard due next run' changes to 'Will discard next run':

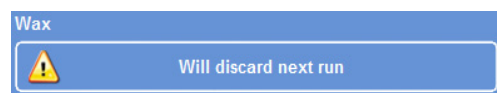

Wax will discard on the next run

Postponing Reagent Rotation

Reagent rotation or wax replacement can be postponed. If this is done, you will be prompted to rotate the reagents and discard wax when you start the next processing run.

Note

Access to the menu options that enable users to override reagent rotations and wax discards can be placed under access control to prevent unauthorised use. For more information, refer to Access Code Protection on page 125.

To postpone reagent rotation:

- Press **Rotation due next run** to select the group of reagent bottles which are due to rotate.
- From the Quality Control menu, press **Postpone Rotation**.
- If you change your mind and want to rotate the reagent, press **Cancel Request**.

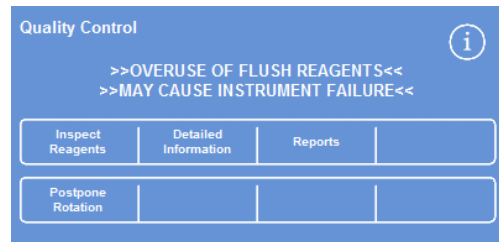

Postponing reagent rotation

To postpone wax discard:

- Press **Discard due next run** to select the wax baths.
- From the Quality Control menu, press **Postpone Discard**.
- If you change your mind and want to discard the wax, press **Cancel Request**.

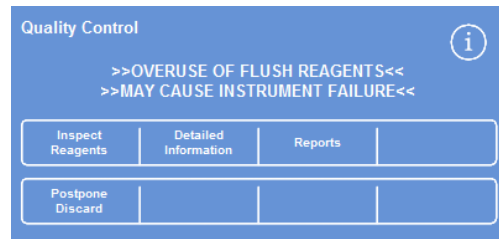

Postponing wax discard

Reagent Rotation Example

A typical example procedure where alcohol, xylene and wax are rotated at the same time, triggered by the quality of alcohol in bottle A1 is described below. The example assumes a schedule of one process run per day.

Day 1

- The alcohol quality has reached its defined limit and a triangle is displayed above the Alcohol Quality Gauge on the Main Screen.
- The Quality Control screen is displayed automatically when the next processing run is initiated.
- The alcohol and xylene buttons on the Quality Control screen both indicate 'Rotation due next run'.
- The wax button indicates 'Discard due next run'.
- Press each label in turn on the display to select the bottles or wax baths and press **Acknowledge** on the Quality Control menu.
- Open the instrument's doors and ensure that the exchange bottles, Ex1, Ex2 are empty and that an empty consumable waste wax tray (WW) is fitted above the wax baths, W1 and W2.
- Close the doors.
- Start processing to continue with the rotation.

Excelsior AS uses reagent A1 as normal and discards it into EX1 at the end of the step. The subsequent alcohol bottles are used in their usual order but all are moved forward by one position when the alcohol is returned. For example, the content of A2 becomes the new content of A1.

The xylene and wax is rotated in a similar way; X1 is discarded into EX2, W1 is discarded into WW.

Day 2

- When the processing run has completed, the display indicates A6, X3, and W3 are empty; Ex1, Ex2 and WW are full.

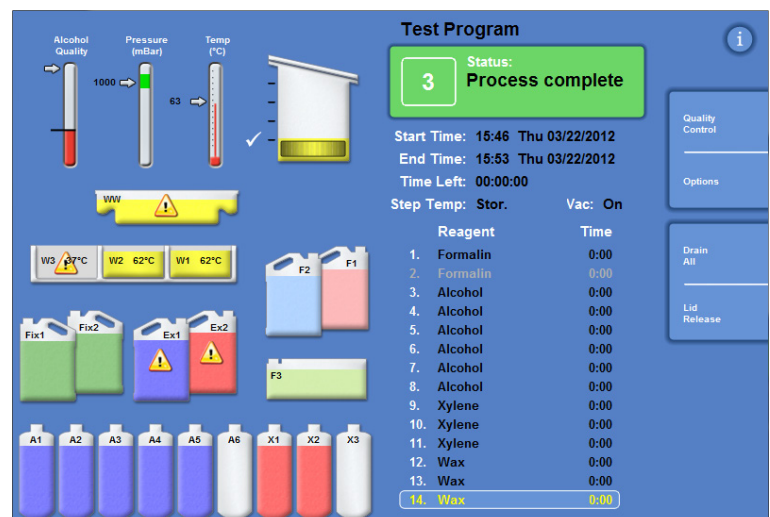

Empty and full positions prior to the completion of rotation

Replace Wax:

- Open the main doors, and carefully take out the consumable waste wax tray.

The Quality Control screen appears.

- Take a new consumable waste wax tray and slide it into position above the wax baths.
- On the Quality Control screen, press the waste wax tray (WW) and then press **Remove**.
- Add wax pellets to the empty wax bath W3.
- Press the **Will not discard next run** button.
- The baths become highlighted.
- Press **Confirm Wax is loaded**.
- While the wax is heating, replace the alcohol and xylene.

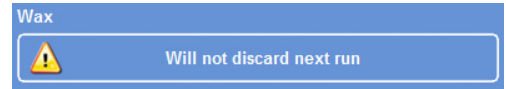

Will not discard button for wax



Confirm wax is loaded button

Replacing the Alcohol and Xylene

- Take out containers Ex1 (waste alcohol) and Ex2 (waste xylene) and dispose of the contents, following local regulations.
- Place new 5 litre (or 1 US gallon) bottles of 100% alcohol and xylene into positions Ex1 and Ex2.

Note:

The majority of under-fill problems on Excelsior AS can be eliminated by using 5 litre reagent bottles.

- On the Quality Control screen, select the **Ex1 Bottle** and press **New**.
- Select the **Ex2 Bottle** on the display and press **New**.

Note

Before continuing, ensure that the wax level is correct; see Loading Wax on page 45 for details.

Running your next process completes the reagent rotation by transferring the fresh reagents to their new positions.

Chapter 4 - Advanced Operation

This chapter describes how to take control of the settings and programs which are used by Excelsior AS to process specimens efficiently and safely. The following subjects are covered:

- Managing and assuring the quality of the reagents and waxes that are used for specimen processing.
- Setting the triggers that prompt operators to change the reagents in order to maintain the quality of specimen processing.
- Controlling how and when specimens are processed.
- Creating new programs and flushes to meet specific processing requirements.
- Adding access code protection to certain system functions.
- Defining the alarms and alerts that are triggered when particular system events or instrument malfunctions occur.
- Saving instrument and program settings to removable media.
- Sending specific system event data from the instrument via a LIMS interface.
- Changing the system time, date and display language.

Reagent Management

Excelsior AS ensures that each reagent is used in the most cost-effective way. When required, you will be prompted to change fixative and flush reagents and to initiate automated discard and reagent rotation processes from the concealed bottles. Unless the instrument is being moved or decommissioned, there will not be any need to remove all of the reagents from the instrument.

Configuring and Loading Reagents

Reagents are configured and loaded when the instrument is set up. For details, refer to Chapter 2 - Installation and Setup, from page 25.

To load in different dehydrants, clearants and infiltrants, you must unload the current set of reagents using the Unload Reagents option (see Unloading Reagents on page 151) and then load in the new set of reagents using the Load Reagents option (see Loading Reagents on page 44).

Reagent and Filter Quality Control

Excelsior AS continually monitors reagents and filters against quality and usage parameters to ensure that processing is safe, reliable and reproducible. These parameters are set manually and determine when quality control alerts to change reagents or filters are issued.

All of the options required to check and monitor reagents and filters are in the Quality Control menu. To display the menu, from the Main Screen select **Quality Control**.

In addition to viewing the status of all reagents and filters you can:

- Acknowledge, request or postpone rotation prompts.
- Draw a particular reagent into the Reaction Chamber for inspection, sampling, topping-up and, if necessary, discarding.
- View detailed information about reagents.
- Run and view reports which provide summary and detailed information on reagent usage.

Reagent, Wax and Filter Checks

The status of reagents, wax and filters can be viewed from the Quality Control screen. Here you will see a combination of colour-coded use counts, warning triangles and rotation status labels indicating which filters or reagents need to be changed or are due to be rotated.

For additional information about the filters, refer to Fitting the Filters on page 29 and Filter and Reagent Usage Information on page 78.

The **Detailed Information** option provides more information on a particular reagent, including loading dates for concealed bottles and wax, reagent usage count and date of the last reagent rotation. For more information, refer to Displaying Detailed Reagent Information on page 94.

Where necessary, any concealed reagent or wax can be drawn into the Reaction Chamber for visual inspection or sampling outside of processing. Refer to Inspecting reagents and waxes on page 95 for more information.

Note

Information for a specific wax bath or concealed reagent bottle is only available using the Detailed Information option.

To check the status of the filters, reagents and wax:

- From the Main Screen, press **Quality Control**.

The Quality Control screen shows the status of the filters, fixatives and flush reagents.

Buttons showing the rotation or discard status are displayed in the Quality Control menu.

- Check the status of reagents, wax and filters and rotate, discard, or change, as necessary.
- Press **OK** to return to the Main Screen.

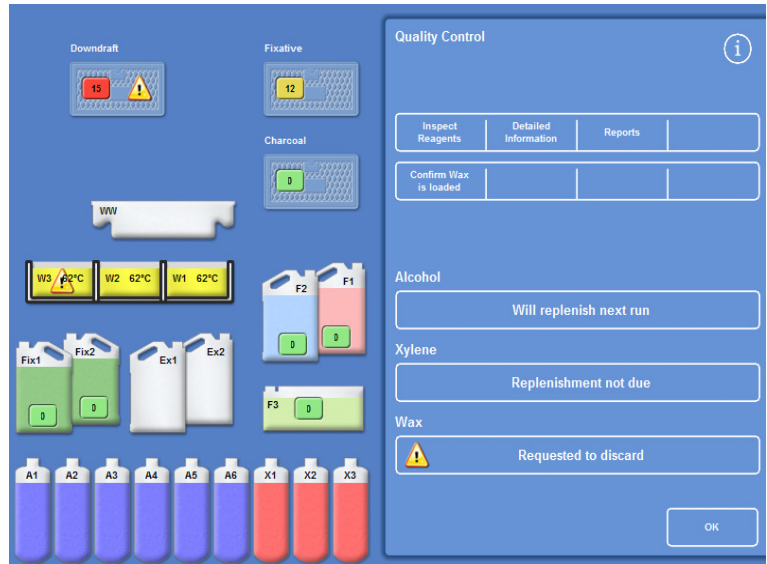

The Quality Control screen

Displaying Detailed Reagent Information

The Detailed Information screen shows information about the usage of the reagent bottles and wax baths.

To view detailed reagent information:

- Select **Quality Control > Detailed Information**.

The Quality Control - Detailed Information screen appears.

Detailed Reagent Information Fields Explained

The following information is displayed on the Quality Control - Detailed Information screen:

Columns	Description
Order Used	The order in which the reagent and wax bottles are used.
Loaded Used	The date the reagent was loaded into the instrument using the Load Reagents option (see Loading Reagents on page 43) and the number of times the reagent has been used at its current position.
Rotated Used	The date that the reagent was last rotated and the number of times it has been used since the rotation.

Rows	Description
Ex1	Exchange bottle – containing discarded reagent
A1, A2, A3, A4, A5, A6	Alcohol bottle positions
Ex1	Exchange bottle – containing new reagent
Ex2	Exchange bottle – containing discarded reagent
X1, X2, X3	Xylene bottle positions
Ex2	Exchange bottle – containing new reagent
WW	Waste wax tray
W1, W2, W3	Wax baths
A1 Quality	Percentage used

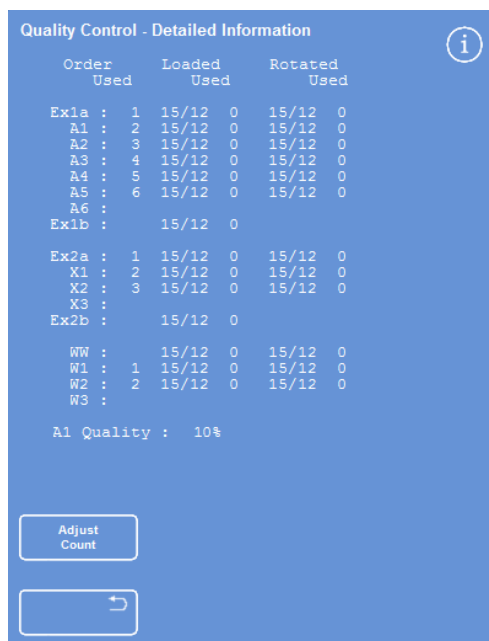

The Detailed Information screen with fixative adjustment

Changing the Fixative Use Count

If you are temporarily using different types of fixative, it is possible to reinstall a fixative count rather than changing it.

- Select the fixative bottle that you want to reinstall.
The bottle is highlighted and an Adjust Count button appears below the A1 Quality information.
- Press the **Adjust Count** button, enter the required use count using the keypad and then press **OK**.
A new use count appears on the fixative bottle.
- Press  to return to the Quality Control menu and Quality Control screen.
- Press **OK** to return to the Main Screen.

Inspecting reagents and waxes

In addition to viewing detailed usage information on reagents, you can draw a reagent into the Reaction Chamber for visual inspection.



Reagents must be inspected in an empty chamber, without baskets.

Once in the Reaction Chamber you can:

- Lift the Reaction Chamber lid and inspect or sample the reagent.
- Check that the volume / fluid level is correct.
When the instrument is loaded from five litre bottles, the chamber fluid level reaches the top of the third level sensor.
If using 1 gallon (US) bottles, the chamber fluid level reaches mid-way between the second and third level sensors.
- Add more reagent if the level is too low.



Wax must be present in the Reaction Chamber for a minimum of 10 minutes before returning to the wax bath.

If wax is drawn into the Reaction Chamber, run a flush before you inspect another reagent or initiate a processing run.

After inspection, the reagent can either be returned to the reagent bottle or wax bath or discarded. If you discard a reagent, you will be prompted to load a new reagent into that position.



When you inspect reagents, there is a risk that processing reagents could become contaminated. Always inspect reagents in an order based upon reagent miscibility and flush between reagent checks.

After inspecting xylene or equivalent reagents, run a flush before further processing. Refer to Flushing the Instrument on page 71 for details.

Inspecting a Reagent

You can inspect any of the instrument's reagents, including the dehydrants (A1–A6) and clearants (X1–X3) in the concealed bottles at the back of the instrument and the wax in the three wax baths (W1–W3).

Note

You cannot start a processing run when you are inspecting a reagent. After inspection, ensure that you either return the reagent to its bottle or wax bath or discard it and load a new reagent after inspection. The Process and Flush buttons are not displayed when inspecting a reagent.

To inspect a reagent:

- Select **Quality Control > Inspect Reagents**.
- Select the reagent that you want to inspect by pressing the bottle or wax bath on the touch screen.

The reagent bottle or wax container will become highlighted.
- On the Quality Control - Inspect Reagents menu, press **Inspect Reagent**.

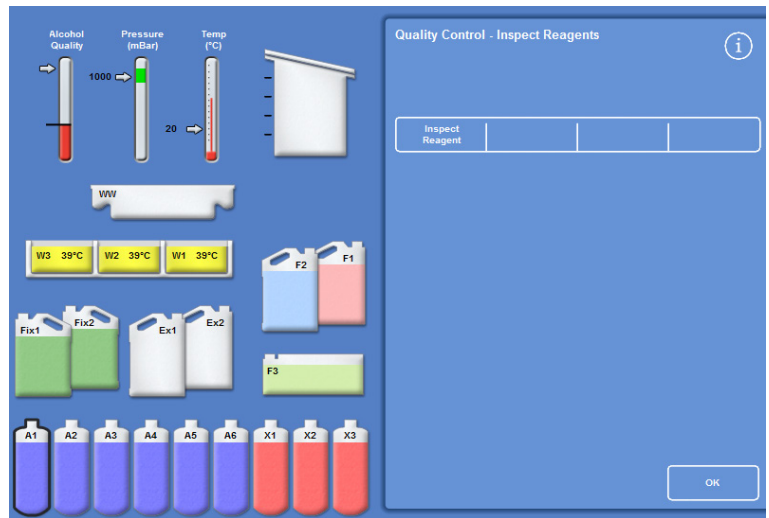

Highlighted reagent at position A1, selected for inspection

The selected reagent is transferred to the Reaction Chamber:

- Lift the chamber lid and inspect or sample the reagent, as required.

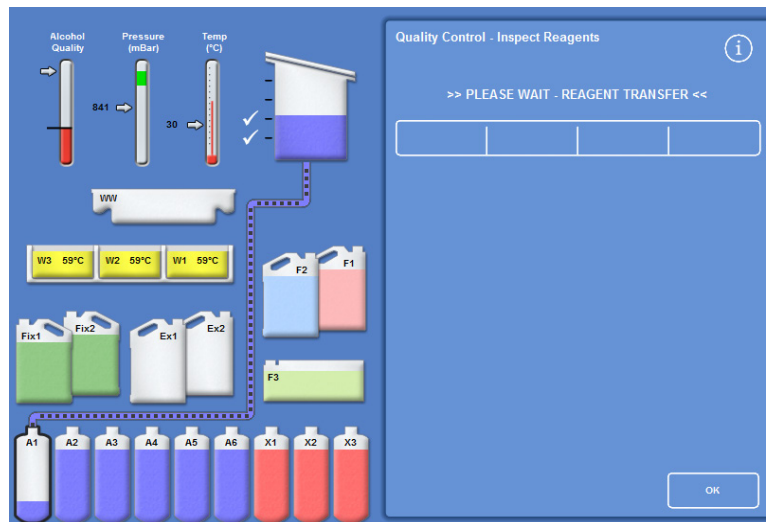

Reagent transfer from A1 to the Reaction Chamber

- Check that the fluid level is correct. If not, more reagent can be added to ensure that the level in the Reaction Chamber is correct.
- After checking, choose from one of the options displayed on the Quality Control - Inspect Reagents screen.
- Press **Return Reagent** to keep the reagent and drain it from Reaction Chamber back into the same bottle or wax bath. You can then inspect another reagent.

- or -

Discard the reagent or wax using the **Discard** option.

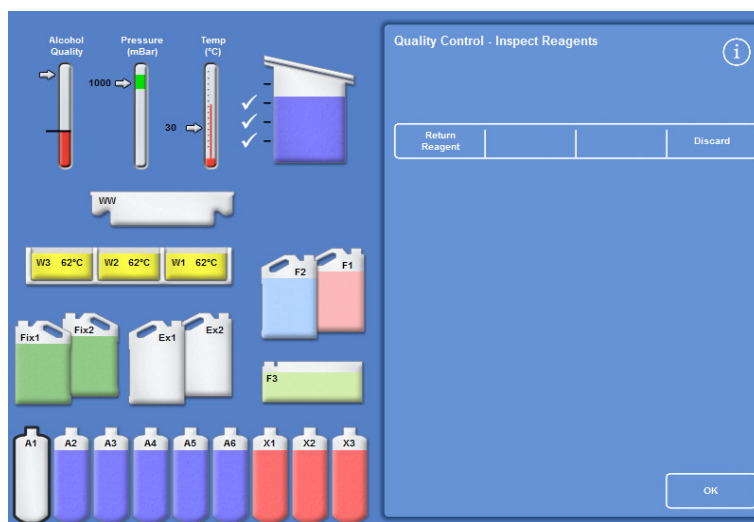

Reagent inspection options

Note

If you are inspecting different reagent types, inspect them in a logical sequence and ensure that you flush the Reaction Chamber as necessary to prevent reagent contamination.

Discarding a Reagent after Inspection

Reagents or wax can be discarded after inspection, if required.

To discard a reagent:

- Inspect the reagent in the reaction chamber.
- Press **Discard**.
- Ensure that you have placed an empty bottle in position Ex1 or Ex2.
- Press **Confirm Loaded** to drain the reagent from the reaction chamber into the empty exchange bottle.
- Discard the used reagent in accordance with local procedures and regulations.

To discard wax:

- Inspect the wax in the reaction chamber.

Note

Wax must be present in the Reaction Chamber for a minimum of 10 minutes before returning to the wax bath.

- Press **Discard**.
- Ensure that an empty consumable wax waste tray is installed in the instrument.
- Press **Confirm Loaded** to drain the wax from the reaction chamber into the wax waste tray.
- Discard the waste wax in accordance with local procedures and regulations.
- Fit a new consumable wax waste tray.

Loading a Reagent or Wax After a Discard

Reagents or wax can be loaded after a discard, if required.

To load a reagent:

- Highlight the bottle to be loaded.
- Press **Load Reagent**.
- Ensure that the new reagent is loaded in position Ex1 or Ex2.
- Press **Confirm Loaded** to draw the reagent into the reaction chamber and then into the highlighted concealed bottle.

Note

Do not leave the Inspect Reagents screen during reagent transfer.

To load wax:

- Load wax pellets into the required wax bath.
- Highlight the wax bath that has been loaded.
- Press **Waxbath Heater ON** to start heating.

Rotating a reagent or wax after a discard

Reagents or wax can be rotated manually after a discard, if required.

Note

This option is only available if consecutive bottles are shown as empty while performing an inspection.

To rotate a reagent:

- Inspect the reagent in the reaction chamber.
- Press **Rotate Reagent** to drain the reagent from the reaction chamber into the next concealed reagent bottle.
- Inspect the next reagent and follow the same sequence to manually rotate all reagents.

To rotate a wax:

- Inspect the wax in the reaction chamber.
- Press **Rotate Reagent** to drain the wax from the reaction chamber to the next wax bath.
- Inspect the next wax bath and follow the same sequence to manually rotate all waxes.

Running and Viewing Reports

Various reports are available to help you assess instrument performance and reagent usage.

Reports comprise a range of different event logs that are presented together in order to provide information on specific system events, for example, temperature readings. Reports can be generated according to the time at which events occurred and the event log types.

You can generate a report by selecting a time period and then choosing a report type. Reports can be viewed on screen or saved onto a USB memory stick for viewing on a computer.

Note

Some reports can be large and may be truncated before they are displayed on screen. To see the full report, save the report to USB and view it on a computer.

The following time periods can be specified:

- Last Run: Retrieves the event logs for a chosen report that were generated from the time the last process run was started through to the present time.
- Last 24 Hours: Retrieves all of the event logs for the chosen report that were generated over the previous 24 hours and up to the present time.
- Last 7 Days: Retrieves all of the event logs for the chosen report that were generated over the previous seven days and up to the present time.
- All Data: Retrieves all of the event logs for a chosen report that were generated from the last instrument reset up to the present time.

The following reports are available to view:

- Program Printouts:* A list of all programs and their parameters that are currently installed on the instrument.
- Full Event Log: A log of every event generated from the last instrument reset to the present time.

Note

This report will be very large.

- Concise Event Log: A reduced version of the full event log containing only process log events.
- Quality Control Status:* A single page report showing information about the usage of the reagent bottles and wax baths.
- Quality Control History: Rotation and reagent management event logs, for example, specific gravity readings.
- Temperature Status:* This captures immediate temperature data for the wax and reaction chamber and current fluid levels.
- Temperature History: Shows a range of temperature readings for process and flush cycles.
- Instrument Setup:* Shows the complete set of configuration settings, in text form, that are currently being used on the instrument.

* These reports are independent of the specified time period.

To view reports:

- Select **Quality Control > Reports** to display the Quality Control - Reports screen.
- Choose the time period for the report.
- To display a single report on the screen, press **View** next to the report that you require.
The report is displayed on the screen.
- Use your fingertip on the touch screen to scroll down through the report.
- Press **OK** to exit.

Saving reports:

Note

Before saving reports, ensure that a USB memory stick is in place in the instrument.

- Select an individual report or multiple reports.
After selection, reports are highlighted in yellow.
- Press **OK** to save and exit from the screen.
The light on the USB memory stick flashes while saving is in progress.
- Press **OK** to return to the Main Screen.

Note

OK will appear shaded if a USB memory stick is not inserted.



Quality Control – Reports screen

Reagent Rotation

Excelsior AS uses an in-process system for maintaining dehydrants, clearants and infiltrants. Manually-defined triggers are used to inform an operator, via the Quality Control screen, that a defined reagent has reached its usage limit and should be rotated or discarded. For more information, see Triggers for Reagent Rotation below.

When a reagent is rotated, Excelsior AS completes the process in the following way:

- The used reagent is discarded from the appropriate containers (used for the first steps in these processing groups).
- The rest of the reagents are rotated by moving each reagent *up* by one position.

Note

Be careful to ensure that discarded A1 waste is not accidentally reloaded back into the instrument.

- On the next processing run, fresh reagents are used in the last step for the process groups that have been rotated.

Rotation is automatic and simply requires the operator to acknowledge system prompts, place exchange bottles into the appropriate positions and to load new reagents when prompted to do so. The usage of fixatives, flush reagents and filters is also tracked and system alerts are displayed when these need to be changed.

The rotation process and renewal of other reagents and filters occurs as part of routine processing but can be requested at any time. The process is described in Quality Control, Filter and Reagent Renewal Limits on page 78.

Triggers for Reagent Rotation

Triggers for reagent rotation can be based on days of the week, usage counts or alcohol quality:

- Days of the week: Prompts to rotate reagents or discard wax are issued on the chosen day(s). Multiple days can be highlighted.
- Usage counts: Prompts are issued to rotate reagents or discard wax when the defined usage limit for a reagent or wax is reached.
- Alcohol quality: The specific gravity of alcohol in reagent bottle A1 is monitored. When this falls below a set level and into the red zone on the Alcohol Quality gauge, the Quality Control screen is displayed before processing starts. You are then prompted to acknowledge or postpone reagent rotation / wax discard.

Setting Triggers for Reagent Rotation

The triggers for reagent rotation are set from the Rotation Management screen. When setting triggers based on alcohol quality, take note of the red zone on the Alcohol Quality gauge on the Main Screen, this will move up and down as you adjust the quality threshold.

Note

For optimum reagent utilisation and processing, it is recommended that concealed reagent and wax rotations are based on A1 alcohol quality.

To set rotation triggers:

- Select **Options > Instrument Setup > Rotation Management**.

The Instrument Setup - Rotation Management screen is displayed.

The current rotation triggers are highlighted in yellow. The default trigger is A1 Quality.

Note

It is only possible to have one type of rotation trigger set for each reagent group. The selected trigger will automatically override any triggers that were set previously.



The Instrument Setup - Rotation Management screen

- To base rotation on days of the week, press the button(s) corresponding to the day(s) on which you want to rotate the reagents or wax.

The chosen day(s) will be highlighted in yellow.

- Press **OK** to save.



Rotating based on day of the week (wax on Friday)

- To base rotation on usage counts, press **Use Limit** and set the required limit using the number pad. To turn the limit off, enter **zero (0)**.
- Press **OK** when you have set the required limit.
The Use Limit button will indicate the new limit in yellow, or will read 'Off' if zero has been entered.

Note

If a use limit of zero is entered, a Quality Control rotation trigger will not have been set for that particular group.



Rotation based on use limits

- To base reagent rotation on alcohol quality, press **A1 Quality** for each of the reagent groups.

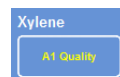

A1 Quality button (for Xylene)

- Use the up and down arrow buttons to adjust the A1 Quality Threshold for earlier or later reagent rotations.



A1 Quality Threshold up and down buttons

The threshold is represented by the red zone on the Alcohol Quality gauge (left side of screen).

Each arrow button press expands or contracts the zone by approximately 1.25% from the black line (starting at 45%).

- Press **OK** to save.
- To return to the Main Screen, press **OK** repeatedly.



Alcohol Quality Gauge

Note

The factory default value for the A1 Quality Threshold is 45%. Be careful if you adjust this value as, over a period of time, any increases or decreases can result in either higher or lower than optimal alcohol concentrations.

Requesting Reagent Rotation

Rotation schedules are automatically controlled by alcohol quality, use counts or days of the week, however it is also possible to add in additional manual rotations as required.

Note

The Quality Control screen is displayed automatically at the beginning of a process run if any of the reagents or filters are due for renewal.

To request rotation of a reagent:

- From the Main Screen, press **Quality Control**.
- On the Quality Control screen, press **Will not rotate next run** to select a group of reagent bottles.
Notice that the bottles are highlighted in black.
- From the Quality Control menu, press **Request Rotation**.

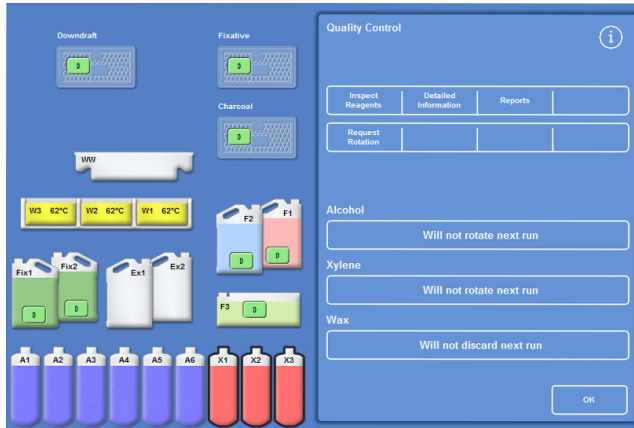

Requesting reagent rotation for X1–X3

The label on the reagent's rotation button changes to '**Requested to rotate**':

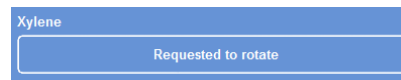

Reagents will rotate next run

- To cancel and not rotate the reagents on the next run, highlight **Requested to rotate** and press **Cancel Request**.
- To return to the Main Screen, press **OK**.

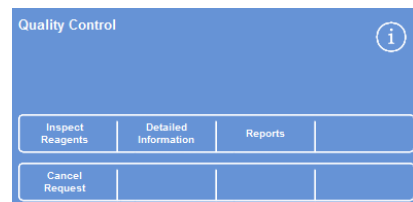

Cancelling the request

To request wax discard:

- From the Main Screen, select **Quality Control**.
- On the Quality Control screen, press **Will not discard next run** to select the wax baths. Notice that the wax baths are highlighted in black.
- From the Quality Control menu, press **Request Discard**.

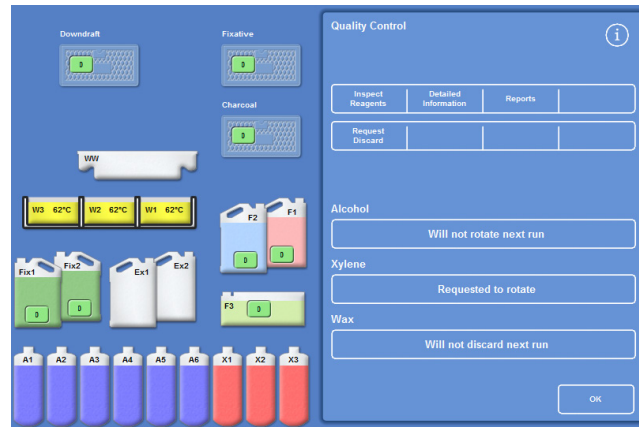

Requesting a wax discard

The label on the wax rotation button changes to '**Requested to discard**'.

- To cancel and not discard wax on the next run, highlight **Requested to discard** and press **Cancel Request**.
- To return to the Main Screen, press **OK**.

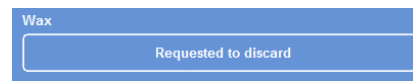

Wax will discard next run

Concept Demonstration

The concept demonstration shows you how reagents are transferred during processing. The demonstration comprises four sections and runs in the following sequence:

1. Loading reagents
2. Processing
3. Discarding reagents
4. Replenishing reagents

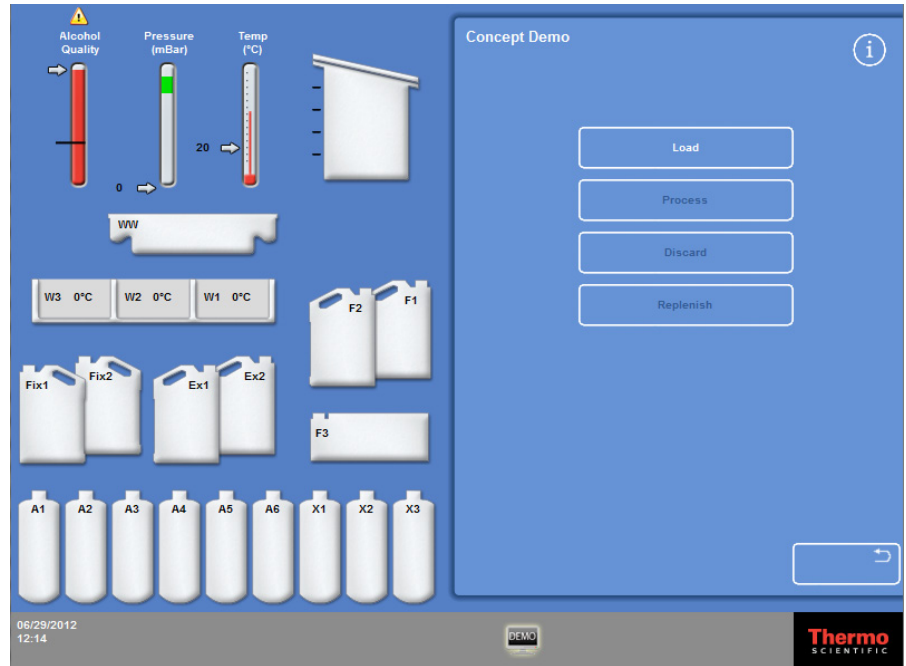

Concept Demonstration

Notes:

- *The demonstration is not available when the instrument is running a process, flush or inspect.*
- *The screen lock function will not operate during a demonstration run.*
- *Any alarms that are generated while the demonstration is running will not be displayed on the screen, however audible alarms will sound, providing that they have been configured to do so, see Audio and Remote Alarms on page 130.*
- *The demonstration will only run in sequence, starting with Load and ending with Replenish.*

To run the demonstration:

- Select **Options > Instrument Setup > Concept Demo**.
The Concept Demo screen appears and the DEMO icon appears on the Information Bar.
- Press **Load**.
The demonstration starts. The Load section and the remaining sections in the sequence are greyed out.
- To exit and return to the Options - Instrument Setup screen, press the  button.
- To pause or restart the demonstration, press the **Pause/Restart** button.
- Once the load demonstration has completed, the process, discard and replenish demonstrations can be run in order.

Customisation and Workflow

Excelsior AS has default settings that will enable your laboratory to process specimens through typical daily processing cycles. In addition, it is possible to change some of the available settings to utilise reagents more efficiently, to change the days of the week that the instrument is available, or to change the programs which are offered by default at various times of the day. These changes are made using the Customisation option which is accessed from the Instrument Setup menu.

Customising Your Instrument

You can customise Excelsior AS, adding your own text to appear at the bottom of the screen, next to the Thermo Scientific logo. You can also specify how the Reaction Chamber is filled, how long a program can be left on hold before an alarm sounds and define when the instrument goes into power-save (dimmed) mode.

To customise your instrument:

- Select **Options > Instrument Setup > Customisation**.

The Instrument Setup - Customisation screen appears.

- To record information about the instrument or your location, press the **Instrument ID** field or the **Customer Text** field.

The on-screen keyboard appears.

- Enter the text that you want to display and press **OK**.
- Select the required filling options, alarm setting and shift pattern. See below for details.
- Press **OK** to save the settings.

Any changes to the Instrument ID and Customer Text will now be shown in the information bar at the bottom of the screen.

- To return to the Main Screen, press **OK** repeatedly.

The Instrument Setup - Customisation screen

Customisation Options Explained

The following table summarises the Excelsior AS customisation options:

Option	Description
Instrument ID	A text field which can be used to record information about the instrument. A maximum of 30 characters can be entered. The text is displayed at the bottom of the Main Screen, next to the Thermo Scientific logo. The text is also added to reports to help with identification, see File Operations on page 132 for more information.
Customer Text	A text field which can be used to record customer-specific information. A maximum of 30 characters can be entered. The text is displayed at the bottom of the Main Screen, next to the Thermo Scientific logo and under the Instrument ID text.
Level Key	When selected (yellow text), a Level button is displayed on the Reaction Chamber Available screen allowing the Reaction Chamber to be filled to a specific level when starting a process. See Setting the Fill Level on page 59 for more information. If this option is not selected, the Reaction Chamber will always be filled to the Random basket level and a Level button is not displayed on the Reaction Chamber Available screen.
Restart Level	<p>Note</p> <p><i>This option is only available if the Level Key is selected.</i></p> <p>When selected (yellow text), Excelsior AS assumes that specimens have been added whenever the lid is opened during processing and fills the Reaction Chamber to the Random basket level on restart.</p> <p>When not selected, the Reaction Chamber is filled to the specified level on restart.</p>
Workflow Setup	Opens the Customisation - Workflow Setup screen. See Setting the Workflow Processing Options on page 109 for details.
On Hold Alarm	This setting specifies how long a program can be left on hold before an alarm sounds. Press the button to set the required time (1–30 minutes or Off).
Shift Start	This setting defines the start of the working day; this is when the instrument comes out of power-save (dimmed) mode. Press the button to specify the shift start time.
Shift End	This setting defines the end of the working day; this is when the instrument goes into power-save (dimmed) mode. Press the button to specify the shift end time.

Setting the Workflow Processing Options

Excelsior AS can be setup to operate in one of three different processing modes:

- Single Program:** This option allows you to define a single default program which will be available to operators at all times of the day.
- Daytime Overnight:** If specimens are processed overnight and also during the day, this option allows you to specify the programs that will be available at specific times of the day.
- No Default:** If there are different groups of operators using the instrument, the default program option can be removed to allow operators to select the program that they want to use when the Reaction Chamber lid is opened.

Note

If required, operators can still choose a different program from the displayed default when processing specimens.

To set workflow processing options:

- Select **Options > Instrument Setup > Customisation**.
- From the Instrument Setup - Customisation screen, press **Workflow Setup**.

The Customisation - Workflow Setup screen appears:

- Select the required options. Additional fields may appear depending on the options that you choose (see Workflow Setup Options Explained on page 110).

If you select **Single Program**, the instrument will assume you wish to process specimens overnight and offer the default overnight program.

If you select **Daytime Overnight** you will be required to specify the program offered during the day (up until the time that you select in **Available Until**) and the overnight program.

- To change any one of the default programs, press the appropriate program button and choose the required program from the Select a Program screen.
- Press **OK** to save the selected workflow options.
- To return to the Main Screen, press **OK** repeatedly.



The Customisation - Workflow Setup screen

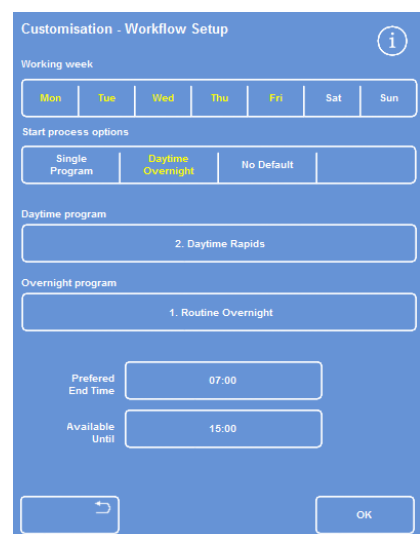

Daytime Overnight processing option selected

Workflow Setup Options Explained

The options and settings on the Customisation - Workflow Setup screen are as follows:

Option	Description
Working Week	Sets the days of the week that the instrument will be in use. Selected days are shown in yellow.
Start Process Options	<p>Sets the process type which is selected when you initiate a processing run. You can choose from:</p> <p>Single Program: One program (the default program) is offered by default at all times of the day. Choose this option if you only run one type of process.</p> <p>Daytime Overnight: Different programs can be set for daytime and overnight processing. Choose this option if you routinely process specimens during the day and overnight.</p> <p>No Default: No program is offered by default and the operator must manually select the required program. Choose this option if you are using Excelsior AS to run a variety of process types.</p>
Default Program	If Single Program is selected, the program that is offered at all times of the day is set here. Press the button to choose the required default program from the Select a Program screen.
Daytime Program	If Daytime Overnight is selected, the program that is offered for daytime processing is set here. Press the button to choose the required daytime program from the Select a Program screen.
Overnight Program	If Daytime Overnight is selected, the program that is offered for overnight processing is set here. Press the button to choose the required overnight program from the Select a Program screen.
Preferred End Time	Sets the end time for the chosen delayed start program (does not apply to an immediate start program).
Available Until	The latest time Excelsior AS will offer the daytime program. After this time, the overnight program will be offered. Press the button to set the time.

Programs and Flushes

Excelsior AS uses programs and flushes to process specimens or flush the system prior to another processing run. Programs and flushes are built up from a series of user-defined steps or instructions. Each individual step comprises a number of parameters which can be set individually or applied to a group of steps using the same reagent type. Steps can also be disabled if, for example, you want to use only one fixative step or are using xylene-free processing.

The following step parameters can be changed:

- The temperature of the reagent used in a particular step.
- The time for the processing step.
- The vacuum conditions under which the processing step takes place.
- The time that specimens are allowed to drain between processing steps.

Viewing Program or Flush Details

You can view details of all of the programs and flushes that have been defined on your instrument. The individual program or flush steps can be changed, as required. See Editing a Program or Flush on page 119 for more information on changing programs and flushes.

To view program details:

- From the Main Screen, select **Options > Edit Program** to display the Select a Program screen.
- Choose the program that you want to view.

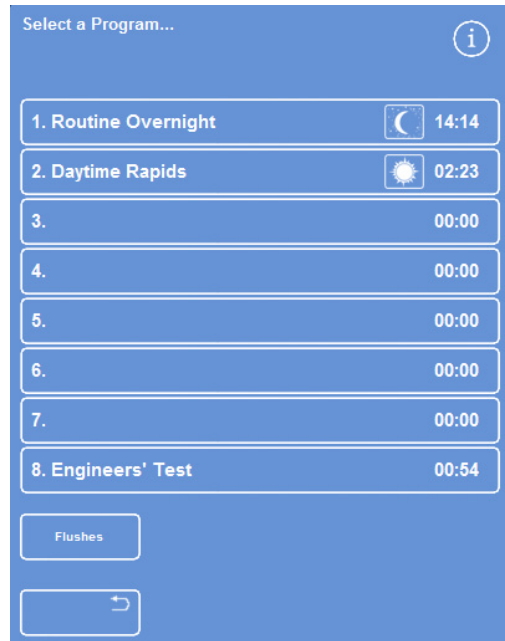

Selecting a program



The Options - Edit Program screen displays details of the fixative and dehydrant steps in the selected program.

Note

To display steps for clearants and infiltrants, press the  button.



Fixative and dehydrant step details

- To return to the Select a Program screen, press .
- To return to the Main Screen from the Select a Program screen, press  and then **OK**.



Clearant and infiltrant step details



To view flush details:

- From the Main Screen, select **Options > Edit Program**.
- Press **Flushes** and choose the required flush program from the screen:



Selecting a flush

The Options - Edit Flush screen displays details of the selected flush:

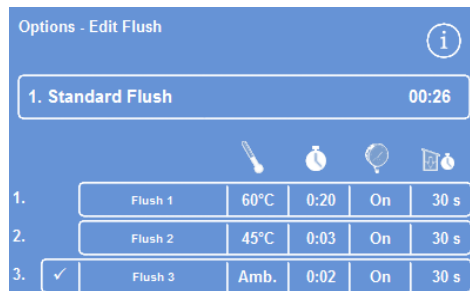

- Press  to return to the Select a Flush screen.
- To return to the Main Screen from the Select a Flush screen, press  and then **OK**.





Flush details

Program and Flush Parameter Fields Explained

Each step in a program or flush comprises a set of parameters which can be adjusted independently. These parameters are explained in the following table:

Parameter	Description
Step Number	Shows the step number in the program or flush. Each program can have up to 14 steps. Flushes have three steps.
Selection box 	<p>Press this box to include or exclude a fixative step or dehydrant / infiltrant / clearant group from the program or flush. If a step is disabled, it is shown as shaded on the Monitoring screen during a program or flush run.</p> <p>Note</p> <p><i>The selection box is not available for mandatory flush steps.</i></p>
Reagent Name / Reagent Group Name	<p>Shows the name of the reagent or reagent group.</p> <p>For more information on reagent names and storage temperatures, see Defining Reagent Names on page 39 and Setting Reagent Storage Temperatures on page 40.</p>
Temperature 	<p>Shows the usage temperature for the program or flush step. This can be different from the storage temperature.</p> <p>Press the button to specify the required step temperature.</p> <p>Note</p> <p><i>Reagents cannot be cooled.</i></p>
Time 	<p>Shows the time (hours and minutes) for each processing step - the maximum is 99:59. Press the button to specify the required step time.</p> <p>Note</p> <p><i>The time to transfer reagents is included in this time. Steps should be at least three minutes long. If a shorter step is entered, and fluid transfers take longer than three minutes, then the program will overrun its expected end time.</i></p> <p><i>The first wax step in any program should be at least 10 minutes long in order to minimise wax carry-over on the Reaction Chamber walls, and to allow the level sensors to warm up to the wax temperature.</i></p>

Parameter	Description
Vacuum 	Controls the vacuum conditions in the Reaction Chamber during each step. Three settings are available, press the button to select the required setting: On: Specimens are held at atmospheric pressure. Off: Specimens are held at approximately 650 mbar absolute (350 mbar below atmospheric pressure). Cycle: Specimens are held in a increasing/decreasing, 15 minute, pressure cycle that ranges from approximately 650 mbar absolute (vacuum conditions) through to atmospheric pressure.
Drain Time 	Shows the time (seconds) allowed for the specimens to drain before moving to the next processing step. Press the button to specify the required drain time (minimum of 30 seconds).
Immediate Start	When selected, the program will default to an immediate start.
Delayed Start	When selected, the program will default to a delayed start.

Creating a New Program or Flush

New programs and flushes can be defined as required. To make this easier, default step details are loaded when you select an empty program or flush 'slot'. These can then be amended to create the program or flush that you require.

Note

Try to make the name of any program or flush that you create as descriptive as possible, but limit the description to 17 characters. Up to eight programs and eight flushes can be defined.

To create a new program:

- From the Main Screen, select **Options > Edit Program**.
- Press an empty button on the Select a Program screen. Programs with a name and time already have defined program steps:

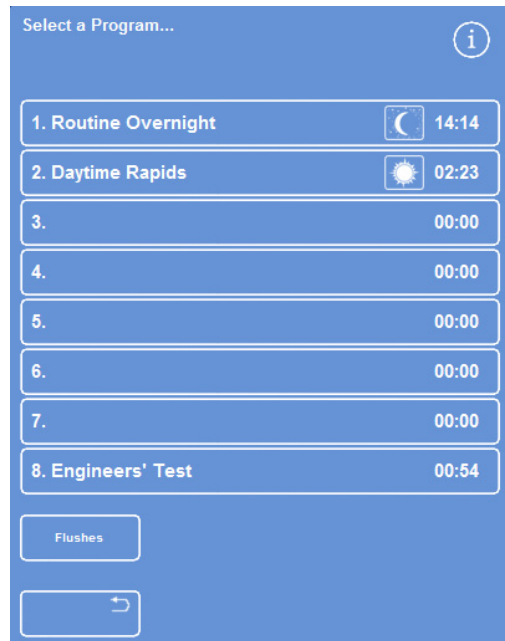

Empty buttons: 3 to 7

The Options - Edit Program screen is displayed:



Adjust the displayed values as required

- Enter a name for the new program.
To do this, press the empty program name button and use the on-screen keyboard to enter the name.

Note

A maximum of 17 characters can be used for program and flush names.

- Press **OK** to confirm the name.



Press to define the program name

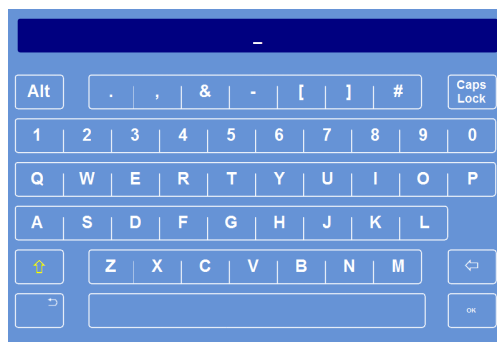

Using the on-screen keyboard

- The steps are disabled by default; to enable one or more of these, press the selection box to the right of the step number.

A tick (check mark) will appear in the box and the corresponding reagent container or containers will become highlighted.

- Define the program step details, adding in the individual step and drain times.

1.	<input checked="" type="checkbox"/>	Formalin	Amb.	0:10	Off	30 s
2.	<input checked="" type="checkbox"/>	Formalin	Amb.	0:10	Off	30 s

Steps 1 and 2 enabled (tick in box)

Note

The default step time is 10 minutes, and the default drain time is 30 seconds.

The total time is shown to the right of the program name.

- Press **OK** to save the new program.
- Press  to return to the Options screen and then **OK** to return to the Main Screen.

For more information on changing parameters, see Changing Program or Flush Step Parameters on page 120.

Note

If program or flush step parameters are edited, the Step / Group is automatically enabled.

To create a new flush:

- From the Main Screen, select **Options > Edit Program**.
- Press **Flushes**.
- Press an 'empty' button on the Select a Flush screen. Flushes with a name and time already have defined flush steps.

The Options - Edit Flush screen is displayed:

- Enter a name for the new flush. To do this press the name button and use the on-screen keyboard to enter the name.
- Press **OK** to confirm the name.
- Define the flush step details. See Changing Program or Flush Step Parameters on page 120 for details.

The total time is shown to the right of the flush name.

- Press **OK** to save the new flush.
- Press  to return to the Options screen and then **OK** to return to the Main Screen.

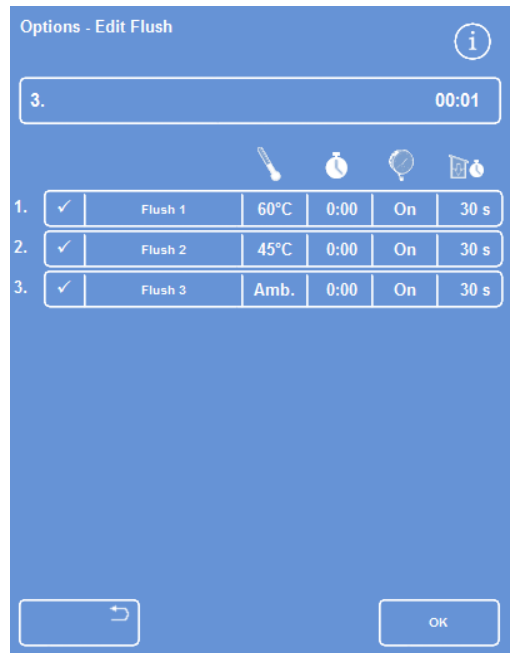

Creating a new flush

Editing a Program or Flush

You can make changes to an existing program or flush so that the steps or conditions match your requirements.

Note

It is recommended that you do not change the default programs and flushes that are provided with Excelsior AS. Instead, create a new program or flush and change that, as required. See Creating a New Program or Flush on page 116 for details.

Flush 1 and Flush 2 cannot be omitted from default flush programs.

To edit a program:

- From the Main Screen, select **Options > Edit Program**.
- Select the program that you want to change.
- On the Options - Edit Program screen, make the required changes to the program or step details. See below for details.
- Press **OK** to save the changes.

To edit a flush:

- From the Main Screen, select **Options > Edit Program**.
- Press **Flushes** and select the flush that you want to change.
- On the Options - Edit Flush screen, make the required changes to the flush or step details. See below for details.
- Press **OK** to save the changes.

Note

*If you have made any changes to a program or flush and press  on the Options - Edit Program screen or Options - Edit Flush screen, you will be asked to confirm that you want to discard unsaved changes. To confirm, press **OK***

*If you want to save the changes that you have made or continue working on a program or flush, press  to return to Options - Edit Program screen or Options - Edit Flush screen. To save any changes press **OK***

Changing the Program or Flush Name

You can change the name of a program or flush, as required. Try to make names as descriptive as possible, but limit the description to 17 characters.

To change the name of the program or flush:

- From the Main Screen, select **Options > Edit Program**.
- Select the program or flush that you want to change.
The Options – Edit Program for the chosen program or flush appears.
- Press the existing name button to display the on-screen keyboard.
- Enter the new name and press **OK**.

Changing Program or Flush Step Parameters

Each step in a program or flush comprises several parameters, each of which can be changed. If you change a parameter for a reagent within a group, it is also possible to copy that change to the other reagents in the group.

Usage Temperature

You can set the usage temperature on an individual basis; 1-55°C for each reagent, 45-65° for wax and a maximum of 65° for Flush 1.

The temperature cannot be set lower than the reagent storage temperature. Storage temperatures are set using the Reagent Storage Temperature option. See Configuring Reagents on page 39 for details.

The current usage temperatures for each reagent within a program group are displayed on the Edit Program or Edit Flush screen under the thermometer icon:

Amb.

To use the reagent at ambient temperature (for use with fixatives, dehydrants and clearants).

Stor.

To use the reagent at storage temperature (for use with dehydrants, clearants and waxes).

35°C

To use the reagent at a specific temperature (for use with all reagents).

To set the usage temperature for a program or flush step:

- From the Main Screen, select **Options > Edit Program**.
- Select the program or flush that you want to change.
- In the column labelled with the  icon, press the current usage temperature for the required reagent.

Note

To access the settings for the program clearant and infiltration groups, press the  button.

The current temperature selection is shown at the top of the screen.

- Use the number pad to set the usage temperature. Alternatively, press **Amb.** to use the reagent at ambient temperature or **Storage Temp.** to use the reagent at its storage temperature.
- To copy the setting to other members of the reagent group, select **Copy To Group**.

Note

Ambient is not available for infiltrants and storage temperature is not available for fixatives. Copy To Group is not available for a fixative (steps 1 and 2) or flush steps.

- Press **OK** to save your setting and return to the Options – Edit Program screen.

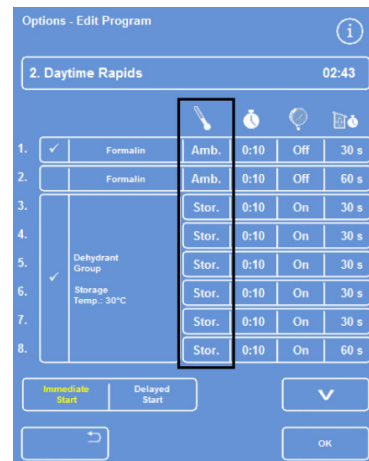

Edit Program screen (step temperature highlighted)

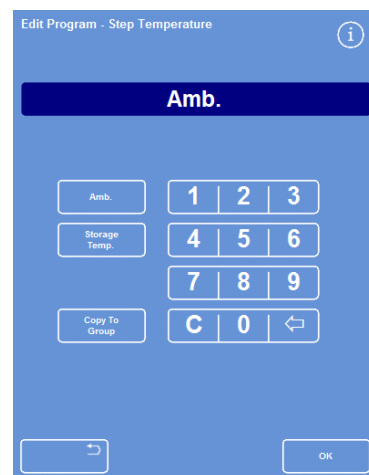

The Edit Program - Step Temperature screen (alcohol and xylene)

Step Time

You can set the time for each step in a program or flush. The time to transfer reagents is included in the setting that you choose.

Steps should be at least three minutes long to ensure that all fluid transfers complete on-time.

The first wax step in any program should be at least 10 minutes long in order to minimise wax carry-over on the Reaction Chamber walls, and to allow the level sensors to warm up to the wax temperature.

To set the time for a program or flush step:

- From the Main Screen, select **Options > Edit Program**.
- Select the program or flush that you want to change.
- In the column labelled with the  icon, press the step time for the reagent.

Note

To access the settings for the program clearant and infiltration groups, press the  button.

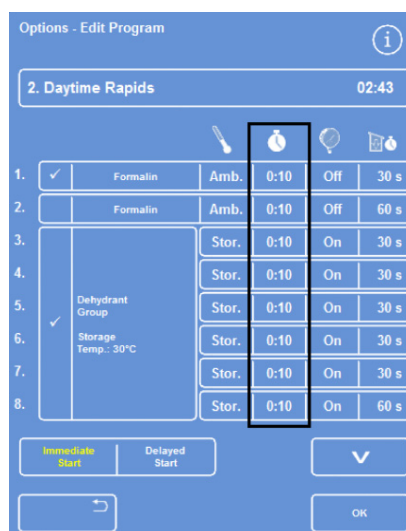

Edit Program screen (step time highlighted)

The Edit Program - Step Time screen is displayed:

- Use the number pad to set the required step time.
- Select **Copy To Group** to copy the setting to other members of the group, if applicable.
- Press **OK** to save your setting and return to the Options – Edit Program screen.

Note

The only way to skip a step is to change the step time to 0:00, although the reagent will still be drawn into the chamber. This is not possible on W1.



The Edit Program - Step Time screen

Vacuum Setting

Each step in a program or flush can take place at atmospheric pressure or under constant or cycled vacuum conditions.

To set the vacuum for a program or flush step:

- From the Main Screen, select **Options > Edit Program**.
- Select the program or flush that you want to change.
- In the column labelled with the  icon, press the vacuum button for the reagent.

Note

To access the settings for the program clearant and infiltration groups, press the  button.

- Select the required condition:
 - Off** Specimens are held at atmospheric pressure.
 - On** Specimens are held at approximately 650 mbar absolute (350 mbar below atmospheric pressure).
 - Cycle** Specimens are held in a increasing/decreasing, 15 minute, pressure cycle that ranges from approximately 650 mbar absolute (vacuum conditions) through to atmospheric pressure.
- Press **OK** to save your setting and return to the Options – Edit Program screen.

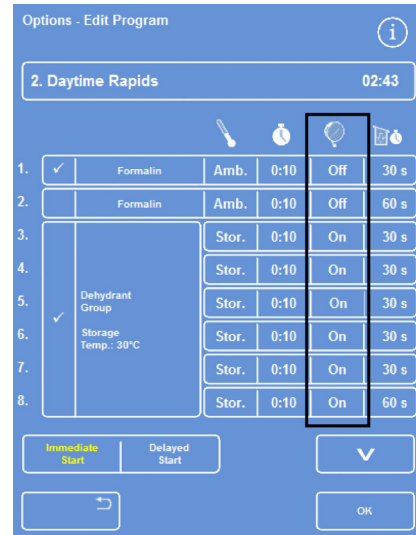

Edit Program screen (step vacuum settings highlighted)

Drain Time

For each step in your program or flush, you can set how long specimens are allowed to drain before moving to the next step.

To set the drain time for a program or flush step:

- From the Main Screen, select **Options > Edit Program**.
- Select the program or flush that you want to change.
- In the column labelled with the  icon, press the drain time for the reagent.

Note

To access the settings for the program clearant and infiltration groups, press the  button.



Edit Program screen (step drain time settings highlighted)

The Edit Program - Step Drain Time screen is displayed:

- Use the number pad to set the required drain time (30-180 seconds).
- Select **Copy To Group** to copy the setting to other members of the group, if applicable.
- Press **OK** to save your setting and return to the Options – Edit Program screen.





The Edit Program - Step Drain Time screen

Enabling and Disabling Individual Steps

To adapt programs and flushes to your needs, you can enable or disable steps from any of the following program sections:

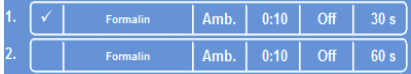
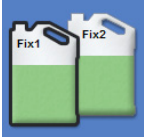
- Individual fixative steps
- Dehydrant group steps
- Clearant group steps
- Infiltration group steps
- Individual flush steps

Example program	Display
Step 1 is enabled and step 2 is disabled:	 <p><i>Enabling and disabling program steps</i></p>
If you disable a step or group, it is also shown not selected on the Main Screen when you are editing the program:	 <p><i>Fix2 is disabled and not selected on the display</i></p>
When the program is run, Step 2 is shown greyed out and will be skipped:	 <p><i>Step 2 is skipped after Step 1 completes</i></p>

To enable or disable a program step or group:

- To disable a step or group, press the step selection box to clear the selection marker (tick).
- To enable a step or group, press the step selection box to display a selection marker (tick).
- Press **OK** to save your changes and return to the Select a Program... screen.
- To return to the Main Screen, press  and then **OK**.

Start Type

You can specify whether you want the program to start immediately or after a delay. Yellow indicates the current setting:

- Immediate Start – The program will start immediately and run through the chosen steps to completion.
- Delayed Start – The start time of the program will be delayed so that the program can run overnight and complete at the Preferred End Time, see Workflow Setup Options Explained on page 110.

Access Code Protection

Access code protection enables the main administrator of the instrument to protect certain system functions. This helps to restrict the level of access that individual or groups of operators have across all menus and options.

To use access codes, a four-digit Admin Code must first be set by the instrument administrator. Once this is set, users can be added and their four-digit access code and level of access defined.

When access code protection has been enabled, the following types of padlock icon are displayed:

- On the Information Bar (bottom of screen):



This indicates that the interface is unlocked for the main administrator (ADMIN). This level of access is protected by the Admin Code.



This indicates that access to the interface is restricted according to the level of access given to a particular user. Their user name is displayed under the padlock.

- On function buttons:

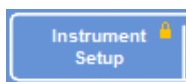

This indicates that access to the function has been restricted. To gain access, the operator must enter a four-digit access code.

Note

The Options – Customer Services – Production Services and Reset Options buttons are permanently restricted. Production Services provides options to assist with fault finding and recovery. Contact your service representative for assistance with these functions.

Access code protection is available for the following functions:

- Options Access to the Options Menu from the Main Screen.
- Instrument setup Access to the Instrument Setup menu.
- Edit program Access to the Edit Program option.
- Modify start Ability to modify start program parameters on the Reaction Chamber Available screen.
- Inspect reagent Access to the Inspect Reagent option from the Quality Control menu.
- QC override Ability to override QC warnings and postpone rotation.

Enabling Access Code Protection

The instrument is shipped without any access codes set. To use Access Codes, you must first set an Admin Code.

To set an Admin Code:

- From the Main Screen, select **Options** > **Instrument Setup** > **Access Codes**.
The Instrument Setup – Set Access Codes screen appears.
- Press **Set Admin Code**.
The Set Admin Code screen is displayed.
- Use the number pad to enter a four-digit Admin access code.
- Press **OK**.
- Re-enter the access code and press **OK**.

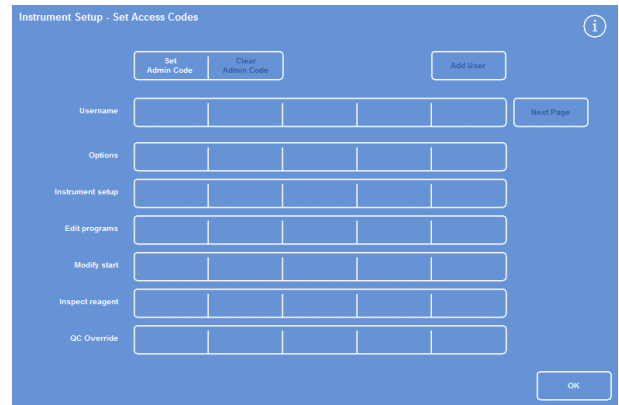

Instrument Setup – Set Access Codes screen

Note

If you re-enter the code incorrectly, you will be prompted to re-enter the code twice.

The Instrument Setup – Set Access Codes screen reappears.

The unlocked ADMIN padlock icon is shown on the Information Bar:



- To log out of the access level that you are using, touch the padlock icon.

Note

Always return to the home screen after touching the padlock icon to prevent unauthorised access to any unprotected functions.



Set Admin Code screen

To clear an Admin Code:

Note

Clearing the Admin Code will permanently delete all users.

- Press the Clear Admin Code button.
Press **OK** to confirm that you want to clear the Admin Code and delete all users.

Adding a New System User

Note

Before adding users to the system, an Admin Code must be set and you will need to have Admin access. An unlocked ADMIN padlock icon, shown on the Information Bar, indicates this. See *Enabling Access Code Protection* on page 126 for details.

To add a new system user:

- From the Main Screen, select **Options** > **Instrument Setup** > **Access Codes**.

The Instrument Setup – Set Access Codes screen appears.

- Press **Add User**.

The Add / Edit User screen appears.

- Press **Name** and use the on-screen keyboard to enter the new user's login name.

Note

A maximum of 5 characters can be used for user names.

- Press **OK**.

The Add / Edit User screen reappears, showing the new user name on the Name button.

- To change the name, press the **Name** button and enter a new name.

- Press **Set Code** and use the number pad to define the user's four-digit access code. Press **OK**.

- Re-enter the access code and press **OK**.

If the code is accepted, the Add / Edit User screen reappears. If the code is not accepted, enter a different code.

- Press **OK** to return to the Set Access Codes screen.

The new user is listed in the Username row.

- To return to the Main Screen, press **OK** repeatedly.

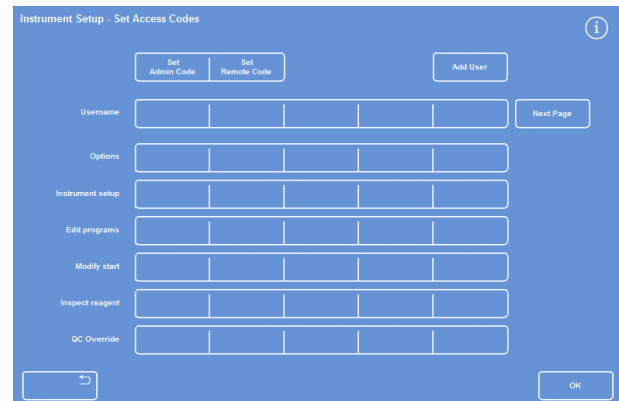

Instrument Setup – Set Access Codes screen

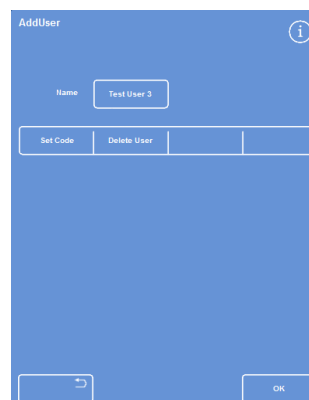

Add / Edit User screen with user name



Setting the user code

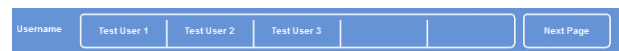

Username row with 3 users added

Granting Access to a Function

Note

Before granting access to functions, an Admin Code must be set and you will need to have Admin access. An unlocked ADMIN padlock icon, shown on the Information Bar, indicates this. See Enabling Access Code Protection on page 126 for details.

To grant access to a function:

- Select **Options > Instrument Setup > Access Codes**.

The Instrument Setup – Set Access Codes screen appears.

- Press the appropriate buttons on the username / function table to select (tick) functions that you want particular users to have access to.
- Press **OK**.

Note

Options must be selected in order for a user to be able to access Instrument Setup and Edit Program.



Adding access to different functions for users

Removing Access to a Function

Note

Before removing access to functions, an Admin Code must be set and you will need to have Admin access. An unlocked ADMIN padlock icon, shown on the Information Bar, indicates this. See Enabling Access Code Protection on page 126 for details.

To remove access to a function:

- Select **Options > Instrument Setup > Access Codes**.

The Instrument Setup – Set Access Codes screen appears.

- Press the appropriate buttons on the username / function table to clear the tick from any functions that you do not want a user to have access to.
- Press **OK**.

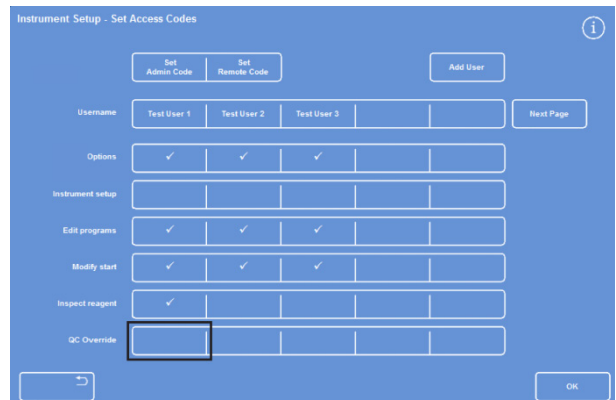

Removing access to QC Override for user Test User 1

Deleting a System User

Note

Before deleting system users, an Admin Code must be set and you will need to have Admin access. An unlocked ADMIN padlock icon, shown on the Information Bar, indicates this. See Enabling Access Code Protection on page 126 for details.

To delete a system user:

- Select **Options > Instrument Setup > Access Codes**.

The Instrument Setup – Set Access Codes screen appears.

- Press the user that you want to delete.

The Add / Edit User screen appears.

- Press **Delete User**.

The Delete User - Confirm screen is displayed.

- To delete the user, press **OK**.

The Instrument Setup – Set Access Code screen reappears.

- To return to the Main Screen, press **OK** repeatedly.

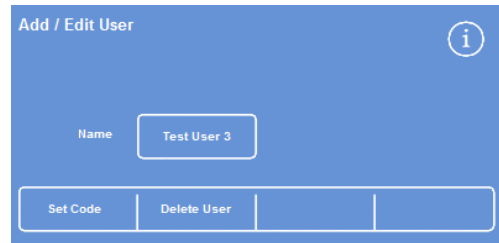

Deleting the user Test User 3

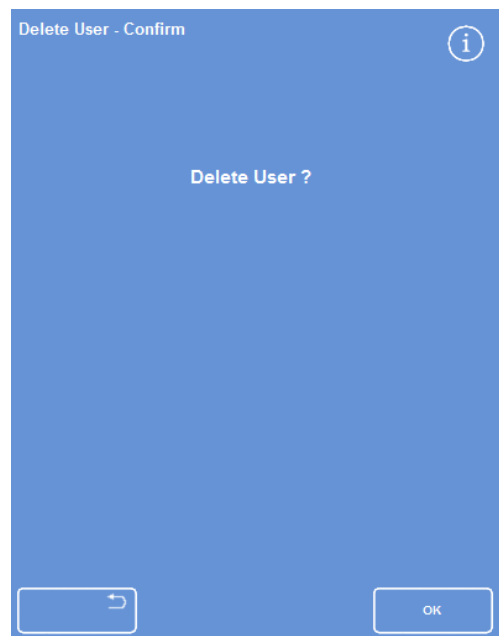

Delete User - Confirm screen

Audio and Remote Alarms

Excelsior AS monitors various system events which can be used to trigger audio and remote alarms. For example, audio alarms can be set to alert operators that the instrument is on hold (the lid has been opened when processing has started) or a program has ended.

Remote alarms can be used to alert on-call managers that an instrument has a fault or mains power has failed. For more information about connecting remote alarms and autodialers, see [Connecting a Remote Alarm](#) on page 32.



External circuits should only be connected to the Remote Alarm socket by a technically competent person.

The external circuit should comply with the requirements of either IEC 61010-1 or IEC 60950, or both.

Using Audio and Remote Alarms

The Instrument Setup - Audio Remote Alarms screen displays a list of system events that can be monitored.

From here you can configure the system to play a sound and / or trigger a remote alarm should any of the listed events occur.

- To access the screen, select **Options > Instrument Setup > Audio / Remote Alarms**.

Event	Sound	Repeat	RA1	RA2
▶ Key Pressed	Chime	0	Off	Off
▶ Power On	Click	0	On	Tune
▶ Program end	Complete	0	Off	Off
▶ Flush end	Ding	0	Off	Off
▶ QC reagent usage	Notify	0	Off	Off
▶ QC filter life	Warning	0	Off	Off
▶ QC cannot start	Startup	0	Off	Off
▶ On hold alarm	Silent	Cont.	Off	Off
▶ Underfill error	Notify	0	Off	Off
▶ Lid open in run	Error	0	Off	Off
▶ Lid left open	Notify	0	Off	Off
▶ Instrument warning	Warning	0	Off	Off
▶ Instrument fault	Notify	Cont.	Off	Off
▶ Mains fail	Notify	0	Off	Off

The Instrument Setup - Audio Remote Alarms screen

Changing the alarm settings

You can change alarm sounds, the number of repeats and enable or disable instrument alarms for events.

Up to two remote alarms can be defined for each event and operated for any combination of events.

Note



The careful setting of alarms helps to ensure that processing quality is maintained and that any faults are identified promptly.

Alarm sound:

- To listen to the current sound, press the  symbol next to the event description.
- To change the current sound, press the sound button for an event until the required sound is shown.
The selected sound will play on each press of the sound button.



Alarm repeat:

- Press the repeat button for an event until the required number of repeats is shown:

	The sound will play once and not repeat.
	The number of times that the sound will repeat after the first play (1 to 5).
	The sound will repeat continuously.

Remote alarm (RA) 1 and 2:

- Press the RA1 / RA2 buttons until the required condition is shown:

	The RA is enabled and will remain active until it is turned off.
	The RA is disabled and will ignore any event that occurs.
	The RA is enabled and will remain on for the duration of the alarm sound repeats.
- To save the settings and return to the Instrument Setup screen, press **OK**.

Remote Alarm Notification Icons

When a remote alarm is triggered an icon displays in the grey bar at the bottom of the interface. The alarm can be silenced by pressing the bell icon.

The following icons can be shown:



Remote Alarm 1 has been triggered.



Remote Alarm 2 has been triggered.



Both Remote Alarm 1 and Remote Alarm 2 have been triggered.

File Operations

Excelsior AS can save programs, flushes and setup information to a USB memory stick for backup or transfer to another instrument. You will find the options to save and load information on the **File Operations** menu.

Note

It is important to save programs and the setup of your instrument to a USB memory stick.

You can use this information to restore your instrument should there be a problem, or transfer the setup, programs or flushes to another Excelsior AS instrument in your laboratory.

Folder Naming

The name of the USB root folder is taken from the instrument's serial number. The report subfolders are named by date and the identification text on the reports is taken from the Instrument ID and Customer Text.

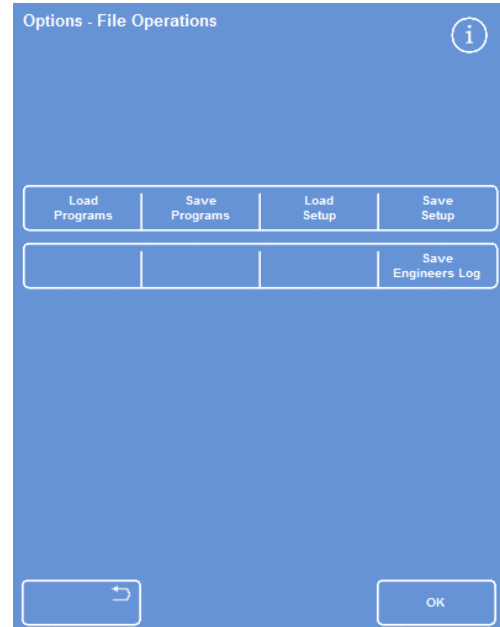

The Options - File Operations menu

Using a USB memory stick with the instrument:



The USB port is for memory sticks only.

Do not connect any other type of USB device to the Excelsior AS.

- Insert a USB memory stick into the USB port. For the location of the USB port, see Identification of Parts on page 17.

Inserting a USB memory stick will prompt the  icon to appear at the bottom of the Main Screen, to the right of the date and time.

- Press the icon to capture an image of the screen.

Images are saved to the root directory of the USB memory stick in a folder called *ScreenDumps*.

Saving Programs and Flushes

Programs and flushes can be saved onto a USB memory stick to provide a backup or for transfer to another Excelsior AS instrument. This can be done with individual programs and flushes, or all programs and flushes.

Note

Before saving or loading programs and flushes, ensure that a USB memory stick is in place in the instrument. If a USB memory stick is not in place, the options will appear shaded.

To save a selected program:

- From the Main Screen, select **Options > File Operations > Save Programs**.
- Select the program(s) that you want to save from the Select a Program screen.
- Press **OK** to save and return to the Options – File Operations screen.

To save all programs:

- From the Main Screen, select **Options > File Operations > Save Programs**.
- Press **Select All** to select all programs on the list.
- Press **OK** to save and return to the Options – File Operations screen.



Select a Program screen

To save a selected flush:

- From the Main Screen, select **Options > File Operations > Save Programs**.
- Press **Flushes**.
- Select the flush that you want to save from the Select a Flush screen.
- Press **OK** to save and return to the Options – File Operations screen.

To save all flushes:

- From the Main Screen, select **Options > File Operations > Save Programs**.
- Press **Flushes**.
- Press **Select All** to select all flushes on the list.
- Press **OK** to save and return to the Options – File Operations screen.



Select a Flush screen

Loading Programs and Flushes

The following types of program and flush can be loaded on to the instrument:

- Individual programs or flushes that have been developed and saved from another instrument.
- All programs or flushes from another instrument.

Notes

When all of the programs or flushes from another instrument are loaded on to the instrument, all of the programs or flushes on the current instrument will be overwritten, after confirmation.

Before saving or loading programs and flushes, ensure that a USB memory stick is in place in the instrument. If a USB memory stick is not in place, the options will appear shaded.

Programs and flushes are loaded from the Load Programs and Load Flushes screens. Both screens have the following options:

Select a source folder From here, you can select a source folder that contains the required program or flush.
Source folders are labelled with the instrument serial number.

Note

Any other folders present on the USB memory stick will also appear on the Select Source Folder screen.

Select a program to load From here, you can select a program or flush from the selected source folder.

Select a destination program slot From here, you can select a program slot that will be overwritten with the chosen program or flush. The default is the next empty program slot.

Load All This enables you to load all programs or flushes from the selected source folder.

Flushes / Programs This enables you to switch between the Load Program and Load Flushes screens.

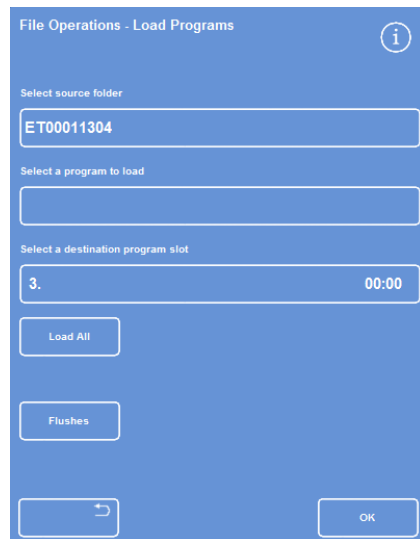

Load Programs screen

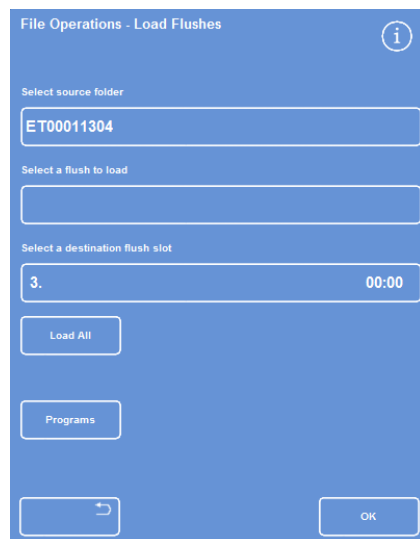

Load Flushes screen

To load an individual program:

- From the Main Screen, select **Options > File Operations > Load Programs**.

The File Operations - Load Programs screen appears.

- To change the source folder, press the **Select a source folder** button and select the required folder from the list.

The Load Programs screen reappears.

- To select the program that you want to load, press the **Select a program to load** button and choose the program.

- Press **OK**.

The File Operations - Load Programs screen reappears and the destination will default to the next empty program slot. This is indicated on the *Select a destination program slot* button.

- To change the destination, press **Select a destination program slot**, select the required slot and press **OK**. You can overwrite an existing program, if required.
- Press **OK** to load the selected program.
- Press the  button to return to the Options screen and then **OK** to return to the Main Screen.

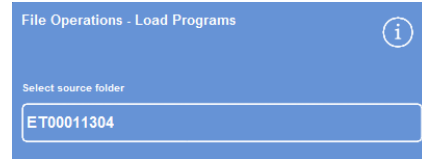

Select a source folder button (Load Programs screen)

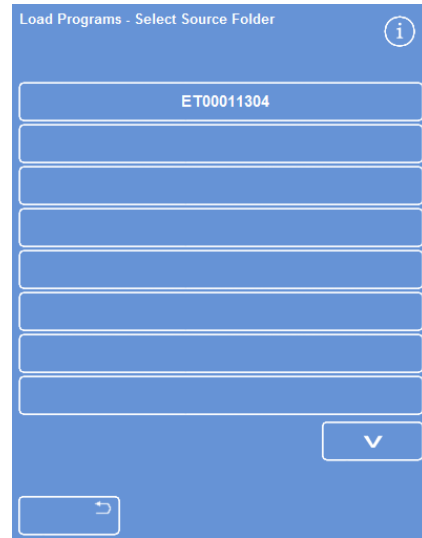

Selecting a source folder from a USB memory stick

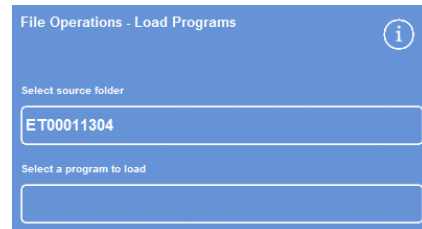

Selecting a program and destination (Load Programs screen)

To load all programs:

- From the Main Screen, select **Options > File Operations > Load Programs**.

The Load Programs screen appears.

- To change the source folder, press the **Select a source folder** button and select the required folder from the list.

The Load Programs screen reappears.

- Press **Load All**.

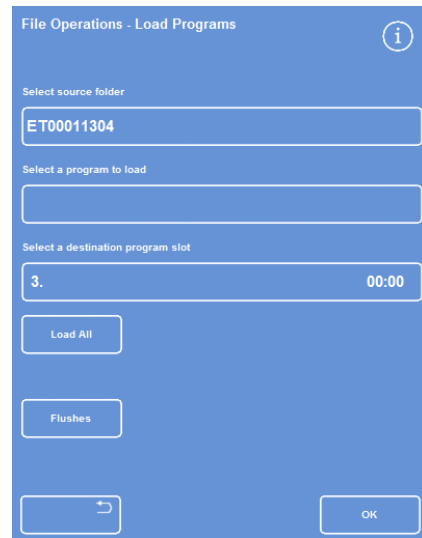

Loading all programs from USB

You will be prompted to confirm that you want to overwrite all of the programs on your instrument.

- To cancel and return to the Load Programs screen, press .
- Click **OK** to load all programs.
- To return to the Main Screen, press **OK** repeatedly.

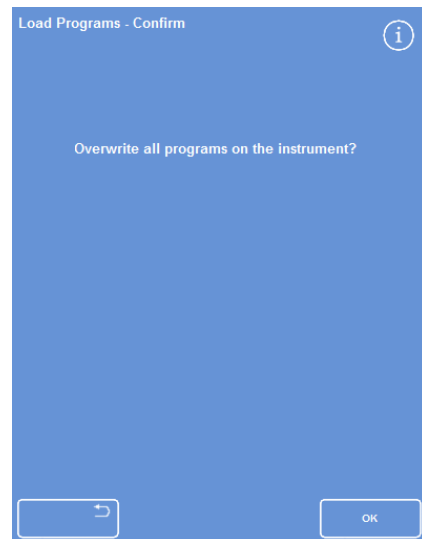

Press OK to confirm

To load an individual flush:

- From the Main Screen, select **Options > File Operations > Load Programs**.
The Load Programs screen appears.
- Press **Flushes**.
The File Operations – Load Flushes Screen appears.
- To change the source folder, press the **Select a source folder** button and select the required folder from the list.
The Load Flushes screen reappears.
- To select the flush that you want to load, press the **Select a flush to load** button and choose a flush.
- Press **OK**.
The Load Flushes screen reappears and the destination will default to the next empty flush slot. This is indicated on the ‘Select a destination flush slot’ button.
- To change the destination, press **Select a destination flush slot**, select the required slot and press **OK**. You can overwrite an existing flush, if required.
- To return to the Main Screen, press **OK** repeatedly.

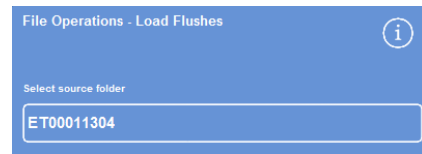

Select a source folder button (Load Flushes screen)

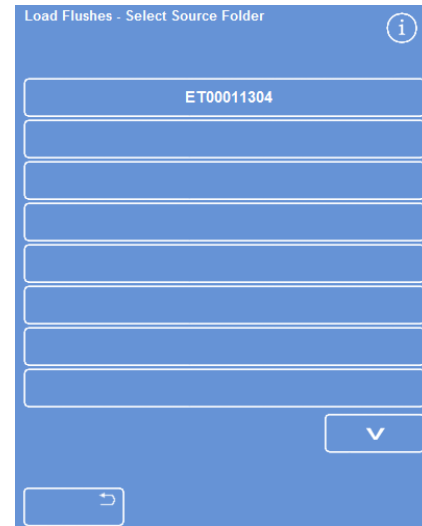

Selecting a source folder from a USB memory stick



Selecting a flush and destination (Load Flushes screen)

To load all flushes:

- Select **Options > File Operations > Load Programs**.
The Load Programs screen appears.
- Press **Flushes**.
The File Operations – Load Flushes Screen appears.
- To change the source folder, press the **Select a source folder** button and select the required folder from the list.
The Load Program screen reappears.
- Press **Load All**.

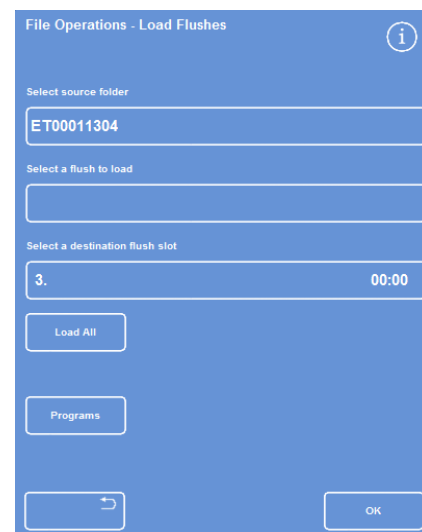

Loading all flushes from USB

You will be prompted to confirm that you want to overwrite all of the programs on your instrument.

- Click **OK** to load all flush programs.

To cancel and return to the Load Programs screen, press .

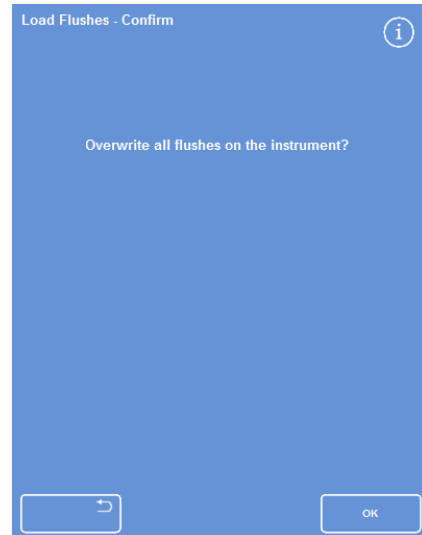

Press OK to confirm

Loading and Saving Setup

Instrument setup information can be saved to a USB memory stick and then loaded from the stick to other instruments. The following setup information is saved:

- Reagent names
- Storage temperatures
- Rotation management settings
- Reagent use limits
- Access code settings

Setup data is saved to the instrument's source folder on the USB stick. Source folders are labelled with the instrument serial number.

Note

Before saving or loading instrument setup, ensure that a USB memory stick is in place in the instrument. If a USB memory stick is not in place, the options will appear shaded.

To save instrument setup:

- Select **Options > File Operations > Save Setup**.

The setup data is saved to the instrument's source folder on the USB memory stick.

Note

Any existing setup data in the source folder will be overwritten. To save more than one set of setup data, use a separate USB memory stick.

To load instrument setup:

- Select **Options > File Operations > Load Setup**.

The File Operations – Load Setup Screen appears. The current source folder is displayed within the Select a source folder button.

- To change the source folder, press the **Select a source folder** button and select the required folder from the list and press **OK**.

The Options – File Operations screen reappears.

- To return to the Main Screen, press **OK** twice.

Setting Laboratory Information Management System (LIMS) Messages

Excelsior AS can be programmed to send user-defined LIMS messages including program start, underfill, alcohol at limit, filter changed and instrument fault. A maximum of 50 characters can be used for LIMS messages.

Note

The message length is also limited to the maximum number of visible characters that the on-screen keyboard can display.

For the location of the Excelsior AS LIMS interface, see *Connecting to a Laboratory Information Management System (LIMS)* on page 34.

To set LIMS messages:



- Select **Options > Instrument Setup > Set LIMS Interface**.

The SetLIMS screen appears.

- Press  to clear any message that has been defined for an event.
- Press within the **Message** box to define an outgoing message using the on-screen keyboard.

Note

A maximum of 50 characters can be used for LIMS messages.

- Press  to send the defined message via the LIMS interface.
- Press **OK** to save any changes and return to the Instrument Setup menu. Press  to return without saving.
- To return to the Main Screen, press **OK** repeatedly.

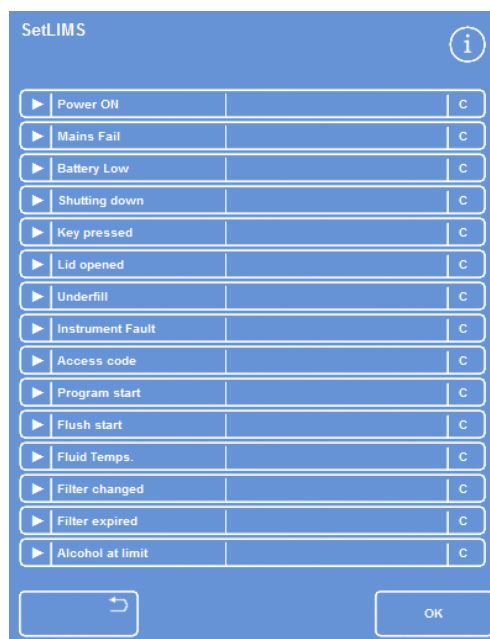

Set LIMS screen

Language

Changing the Display Language

The display language is set when the instrument is setup, but it can be changed, if required.

To change the display language:

- Select **Options > Instrument Setup > Language Select**.
The currently selected language is shown in yellow text.
- Press the button for the required display language and press **OK**.
- To return to the Main Screen, press **OK** repeatedly.



The Instrument Setup - Language Select screen

Customer Services

This menu provides access to a range of options and settings that are used as an aid to fault finding and recovery.

Note

The functions on this screen should be used with caution. Contact your service representative for assistance with these functions.

To access the Customer Services menu:

- Select **Options > Customer Services**.

The Customer Services screen appears.

The following options and functions can be accessed from the Customer Services menu:

- **Production Services:** Production Services provides options to assist with fault finding and recovery.

Note

This button is permanently restricted.

- **Calibrate Touchscreen:** This option starts a utility that will automatically adjust the touchscreen for optimal responsiveness to your touch.

To calibrate the touchscreen:

- Carefully press on the centre of the target (cross).
- Repeat as the target moves around the screen.
- When there are no more targets to press, tap the screen twice to return to the Customer Services screen.

- **Disable Pipes:** From this screen you can disable pipes, connecting the reagent containers with the Reaction Chamber, in order to isolate components.

Note

This facility can be used to remove one reagent in a group from within a program. It should only be used in the event of a fault until a service representative can attend.

- **Reset Options:** From here, you can perform a reset to return the instrument to the factory installed settings and set the instrument to display a full load of reagents for testing purposes.

Note

These options are permanently restricted.

Chapter 5 - Cleaning and Maintenance

This chapter describes how to clean and maintain your Excelsior AS instrument and covers the following subjects:

- Cleaning safety
- Clearing spillages
- Daily and weekly cleaning tasks
- Cleaning reagent bottle dip tubes and the flush water bottle
- Discarding used wax
- Cleaning the touch screen display
- Changing filters
- Checking the instrument on a regular basis
- Taking the instrument out of operation

Cleaning Safety and Tasks

Cleaning Safety

Normal standards of laboratory hygiene and routine maintenance procedures are all that is necessary to keep the Excelsior AS in good and serviceable condition.

Before using any cleaning or decontamination method, except those recommended by the manufacturer, users should check with the manufacturer that the proposed method will not damage the equipment.



Inspect the instrument for obvious damage or wear whenever you clean or use it.



Always wipe up any spills immediately.

In the event of a major spillage, disconnect the instrument from the mains supply immediately and do not reconnect and switch on until the instrument has been thoroughly dried out and checked by a Service Engineer.



If biohazardous material is spilt on, or inside, the instrument you must carry out the appropriate decontamination.



Do not use abrasive compounds or metal components to clean Excelsior AS or its components and accessories.



Always take the necessary safety precautions when you clean or decontaminate Excelsior AS to protect yourself against the effects of chemicals.



As with all scientific equipment, due care and Good Laboratory Practice must be employed when dealing with chemicals, and consideration must be given to the potential for hazard when dealing with particular chemicals.



Unless otherwise stated, only use reagents that appear on the approved list to clean Excelsior AS (see Appendix D - Approved Reagents on page 181).

Clearing Spillages

Any reagent spills within the instrument will be contained. Small spills, such as drips from the reagent tubes when the reagents are changed, will evaporate and be extracted.



Some chemicals which may be used during operation are flammable – do not use sources of ignition in the vicinity of the instrument when it is loaded with reagents.



Harmful chemical vapours such as xylene and toluene may be emitted during the normal operation of some instruments, and the operator should be aware of suitable precautions and safety measures.

To clean large spills:

- Remove all the reagent bottles from the Reagent Storage Area.
- To access the spillage containment area, lift and remove the metal shelf in the base of the Reagent Storage Area.
- Clean and dispose of any liquid from this area in accordance with any local procedures or regulations.
- Replace the metal shelf and the reagent bottles.

Note

Ensure that the metal shelf is the correct way up; the folded edge must be on the top.

Daily and Weekly Cleaning Tasks

The following cleaning tasks must be performed on a daily and weekly basis.

Daily

Check the following on a daily basis:

- General instrument cleanliness.
- Reagent bottle contents (front bottles).
- Level sensors; clean as required.

Weekly

Check the following on a weekly basis:

- Spillage containment area.
- Wax bath contents.
- Level sensors; clean with the provided Level Sensor cleaning pad.

Wax and Wax Baths

Ensure that you wipe out Wax Bath 3 after the wax is rotated and discarded into the waste wax tray.

Discarding Used Wax

When the oldest wax is discarded from the W1 position during a rotation (see *Renewing Dehydrants, Clearants and Infiltrants Using Rotation* on page 83), it is discarded directly into the consumable waste wax tray.

Note

*For information on how to discard wax after an inspection, see *Discarding a Reagent after Inspection* on page 97.*

To discard used wax:

- Open the wax door and carefully slide the consumable waste wax tray from the instrument.



The waste wax tray contains hot molten wax.

- Place the tray in a cool, well-ventilated area away from the instrument and allow the wax to set.
- When the waste wax has set, discard the entire waste wax tray and solid wax in accordance with local procedures and regulations.
- Fit a new consumable waste wax tray into the instrument above the wax baths and close the access doors.



Ensure that there is always an empty waste wax tray in the instrument.

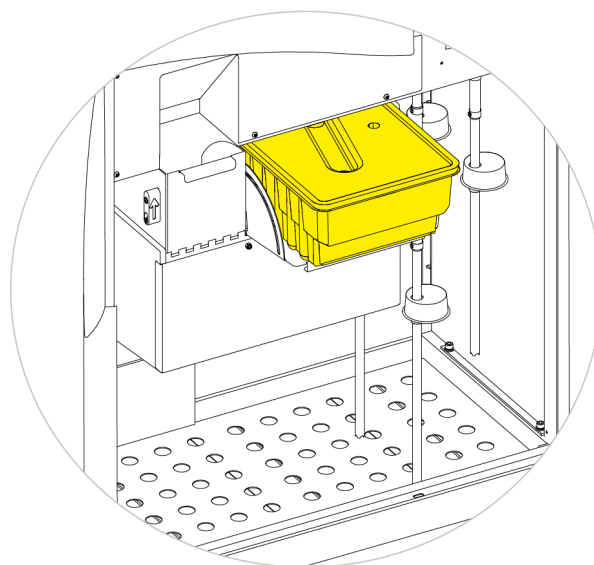

Waste wax tray fitted above W1 and W2

Cleaning the Wax Bath

After a wax rotation has completed, Wax Bath 3 is empty.

To clean the wax bath:

- Open the wax access door on the left.
- Use absorbent paper to wipe out any remaining wax from the wax bath.

Make sure that no paper is left in the wax bath.



The bases of the wax baths are hot.

Always wear protective gloves.

Reagent and Flush Bottles

Ensure that you clean the reagent dip tubes when reagents are replaced.

Note

The Flush 3 bottle should be cleaned and refilled when flush reagents are renewed.

Cleaning the Reagent Supply Bottle Dip Tubes

The dip tubes supplying the following bottles must be cleaned each time the reagents are changed or discarded:

- Fixative 1 (Fix1)
- Fixative 2 (Fix2)
- Exchange 1 (Ex1)
- Exchange 2 (Ex2)
- Flush 1 (F1)
- Flush 2 (F2)
- Flush 3 (F3)

To clean reagent supply bottle dip tubes during reagent change:

- Carefully remove the dip tubes from the reagent bottles.
- Clean any contamination from the surface of the tubes with a lint-free cloth.
- Remove the bottles from the instrument and replace their caps.
- Dispose of the used reagents in accordance with your local regulations and procedures.
- Replace reagents according to the Quality Control and Reagent Renewal procedures. See Quality Control, Filter and Reagent Renewal Limits on page 78.

Cleaning the Flush 3 Water Bottle

The Flush 3 (F3) bottle is located in the cabinet, below the F1 and F2 bottles.

To remove the F3 water bottle:

- Remove the F1 and F2 bottles.
- Remove the green reagent tube from the rear of the F3 bottle and carefully lift and slide the bottle out of the Reagent Storage Area.
- Remove the cap and dispose of the water in accordance with any local procedures and regulations.



Keep the F3 bottle level to avoid any spillage. The F3 bottle must be cleaned before it is refilled with water.

To clean the F3 water bottle:

- Rinse the bottle with clean water and mild detergent.
- Use a bottle brush if required.



Do not use temperatures higher than 60°C.

To refill and refit the F3 water bottle:

- Refill the F3 bottle with water up to the underside of the fill-line (approximately 5 litres).
- Replace the cap.
- Place the water bottle in the Reagent Storage Area with the cap towards the front of the instrument.
- Fit the green tube into the open pipe at the rear of the F3 water bottle.
- Make sure that the tube is fully inserted into the water bottle (so it sits on the bottom of the bottle) and that there are no kinks in the flexible section of tube.
- Replace the F1 and F2 bottles.

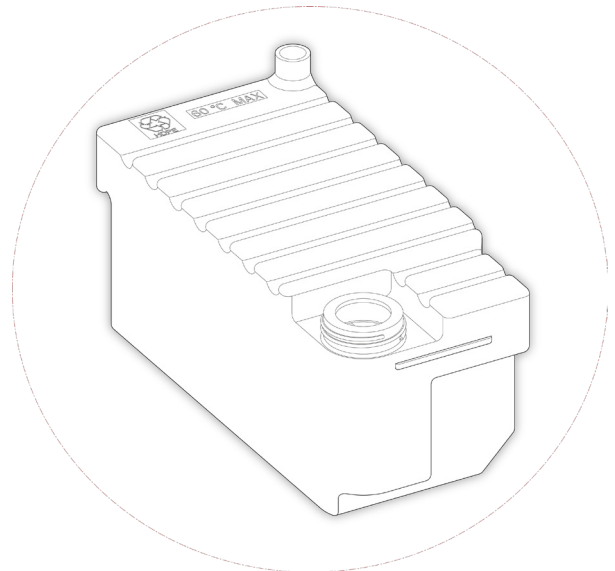

F3 Water bottle with the fill-line visible

General Cleaning and Maintenance

Cleaning the Display

The touch screen display should be cleaned on a regular basis. Ensure that the screen is locked before it is cleaned.

To clean the display:

- Lock the screen. To do this, press and hold the Thermo Scientific logo in the bottom right of the screen until the 'locked screen' icon appears.
- Gently wipe the touch screen with a soft damp cloth.
- Unlock the touch screen. To do this, press and hold the Thermo Scientific logo in the bottom right of the screen until the 'locked screen' icon disappears.



Do not use solvents to clean the touch screen.

Changing Filters

Change the filters every 13 weeks. To replace the filters, follow the instructions in Fitting the Filters on page 29.

Regular Maintenance Checks

The following table describes items that should be checked on a regular basis:

Area	Item	Frequency	What to do
Wax baths	Level	Weekly	Check wax levels in all wax baths.
Lid/Reaction Chamber	Seal	After each processing run	Clean the Reaction Chamber and keep the lid and seal clear of solid wax deposits.
	Level Sensors	After each flush cycle	Carefully wipe with gauze or paper towels.
		Weekly	Clean with tissue or the provided Level Sensor cleaning pad.
	Latch	Whenever the lid is opened	Check that the lid latch operates correctly. The downdraft system should operate and the display should show the lid open.
Reagent Storage Area	Reagent Pipes	When loading or unloading reagents	Check that the flexible parts of the reagent tubes in the front of the cabinet are not damaged or collapsed.
	Reaction Chamber Heater Trip	Monthly	Press the Push-to-Test switch next to the Heater Reset Switch in the Reagent Storage Area. The Heater Reset Switch should operate and the Reaction Chamber Heater trip icon will be displayed on the screen. Press the Heater Reset Switch in fully to reactivate the Reaction Chamber heaters. The Reaction Chamber Heater Fault icon will disappear from the screen.
	Battery Isolation Switch	Monthly	Check the operation of the Battery Isolation Switch during a flush cycle. When the O side is pressed (OFF), the Battery Fault icon should be displayed. When the I side of the switch is pressed (ON), the icon should disappear.

Instrument Shutdown Procedure

For continuous and consistent processing, Excelsior AS should be switched on at all times. However, if the instrument is to be moved, left unattended for extended periods of time, or decommissioned, carry out the following steps.

- Ensure that any processing programs have finished.
- Carry out a flush procedure. See Flushing the Instrument on page 71 for details.
- Unload wax and reagents from the instrument. See Unloading Reagents on page 151 for details.
- Press the O (OFF) side of the main I/O power switch to switch off Excelsior AS.
- When the screen goes blank, wait approximately 10 seconds until you hear a ‘click’ sound.
- Press the O (OFF) side of the Battery Isolation Switch to isolate the battery.

Note

If you want to repack the instrument, refer to Appendix C – Repacking Instructions on page 177.

Unloading Reagents

If required, all of the wax and reagents can be unloaded from Excelsior AS. This should be done in the following situations:

- If you are changing to a different set of reagents.
- If the instrument is to be moved or left unattended for a long period of time.

Unloading removes all reagents via the Reaction Chamber into the waste wax tray and exchange bottles at positions Ex1 and Ex2.

Note

The Unload Reagents option is only available when reagents have already been loaded into Excelsior AS. Refer to Loading Reagents on page 43 for information on loading reagents into the instrument.

Initiating Reagent Unloading

- Select **Options > Instrument Setup > Unload Reagents**.
The Unload Sequence screen appears.
- To unload the reagents from the instrument, follow the on-screen instructions and then press **Unload**.

Unloading Wax

Note

Wear gloves during this procedure due to the high temperature of the wax.

- Ensure the consumable waste wax tray is correctly fitted above wax baths, W1 and W2.
- Press **Unload** to pump the wax from the selected wax bath into the Reaction Chamber and then discard it into the waste wax tray.

Note

At this point, you may need to wait for the wax to reach temperature before the transfer.

- Repeat this process for the other wax baths.

When the last wax bath has been unloaded, the screen instructions will prompt you to start a hot rinse using F1.

- Press **Start** to flush and remove any remaining wax from the Reaction Chamber.

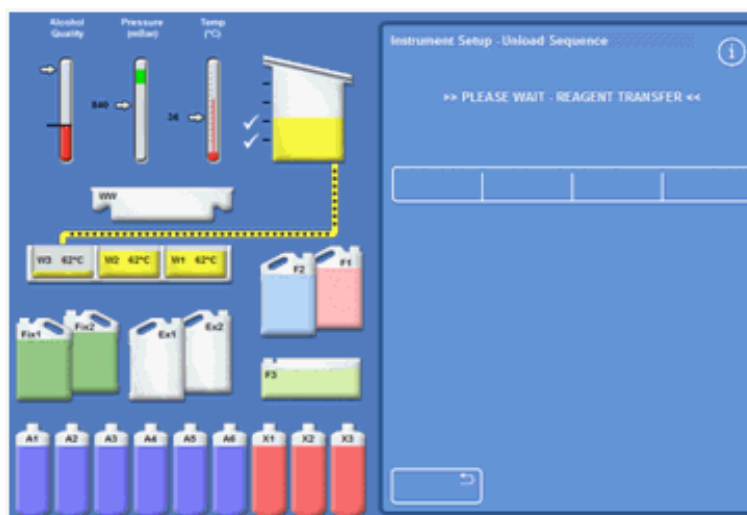

Unloading wax

Unloading Clearants

The unload procedure continues; the Ex2 bottle is highlighted with a red outline and the first clearant bottle (X3) is highlighted with a black outline.

- Confirm that bottle Ex2 is empty and then press **Unload** to continue removing the reagents.

The contents of X3 is drawn into the Reaction Chamber and then pumped into Ex2.

The Ex2 bottle image changes to full, with a flashing black outline and warning triangle displayed within it.

- Remove bottle Ex2 and dispose of its contents in accordance with local procedures and regulations.
- Place another empty bottle in the Ex2 position and press **Unload**.
- Follow the screen instructions to continue removing the remaining clearant reagents.

When all clearants are unloaded you will be prompted to start a flush to remove any remaining clearant from the Reaction Chamber.

- Press **Start** for a hot F2 rinse.
- Press **Start** for a cold F3 rinse.



Unloading clearants – Ex2 and X3 outlined



Unloading clearants – Ex2 full and X2 outlined

Unloading Flush Reagents

- Remove the F1, F2 and F3 bottles from the cabinet and press **Unload**.
- Dispose of waste reagents in accordance with local procedures and regulations.
- Replace F3 back into the cabinet after emptying.



Unloading Flush Reagents, F1 highlighted

Unloading Dehydrants

The unload procedure continues; the first dehydrant bottle (A1) and the Ex1 bottle are highlighted.

- Follow the screen instructions to confirm that the bottle Ex1 is empty. Press **Unload** to continue to remove the reagents.
- Remove the Ex1 bottle and dispose of its contents in accordance with local procedures and regulations.
- Place another empty bottle in the Ex1 position and follow the screen instructions to remove the remaining dehydrants.



A6 dehydrant bottle and the Ex1 position highlighted

Removing Fixatives

- Remove the Fix1 and Fix2 bottles from the cabinet and press **Unload**.
The Instrument Setup menu is re-displayed.
- Dispose of waste reagents in accordance with local procedures and regulations.
- Press **OK** to return to the Options menu and then **OK** again to return to the Main Screen.

Chapter 6 -Troubleshooting

This chapter describes how to troubleshoot problems that may occur when using Excelsior AS and covers the following subjects:







- Recognising alert icons and use the Fault Status screen to identify and resolve problems.
- Dealing with instrument malfunctions, should they occur.
- Solving tissue processing problems.
- A list of frequently asked questions with answers.







Faults

Alert Icons

Excelsior AS places the highest priority on specimen integrity and processing quality. The instrument continually monitors its status, giving clear visual and audible warnings in the event of a problem, and provides specimen safety measures.

- Alert icons appear at the bottom of the screen, to the left of the Thermo Scientific logo.
- The Quality Control and Fault Status screens enable quick diagnosis; these are automatically displayed if you start a program when there are problems with the instrument or reagents. Issues must be resolved before the program will start. For more information, refer to Quality Control Checks on page 61 and Using the Fault Status Screen on page 158.
- The rechargeable battery provides backup power if there is a mains power failure.
- A sounding alarm with remote facility can send warnings outside of working hours.

Icon	Description
	Reaction Chamber Heater Trip Processing cannot start. Open the right cabinet door and press the Reset switch. This icon is normally displayed when power is restored after an interruption. See Instrument Start-up Procedure on page 35.
	Reaction Chamber Heater Trip Due to Error An error has caused the heater to trip. Processing cannot start. Open the right cabinet door and press the Reset switch.
	Access Code The access code has been entered. The name of the user who entered the code is displayed below the icon. See Access Code Protection on page 125.
	Main Cabinet Doors Open This condition displays the Quality Control Screen. Close and lock the cabinet doors then press OK to leave the Quality Control Screen.
	Battery Isolation Switch The battery isolation switch is not on. Open the right cabinet door and turn the rocker switch ON to restore battery backup and ensure power to the instrument. See Instrument Start-up Procedure on page 35.
	Mains Power Failure The instrument is running on battery backup power. The available power is displayed as a percentage. Inspect mains power connections, power cable and mains supply. Some heating functions are limited when running on battery backup.
	Quality Control Alert Open the Quality Control screen for details.

Icon	Description
	<p>Remote Alarm</p> <p>A remote alarm has sounded. The icon indicates whether it is Alarm 1 or Alarm 2. Press the icon to silence the alarm.</p>
	<p>Netmon Session in Progress</p> <p>Netmon information is being downloaded and the instrument is being checked.</p>
	<p>USB Flash Drive Connected</p> <p>A USB memory stick has been connected via the USB port on the front of the instrument.</p> <p>Press the icon to capture an image of the screen. Images are saved to the root directory of the USB memory stick in a folder called ScreenDumps.</p>
	<p>Screen Locked</p> <p>The screen is currently locked. To lock or unlock the screen, press and hold the Thermo Scientific Logo at the bottom right of the interface for five seconds. See Cleaning the Display on page 149.</p>
	<p>Concept Demonstration</p> <p>The Concept Demonstration program is currently active. The screen lock function is not available in Concept Demonstration mode. See Concept Demonstration on page 106.</p>
	<p>Hardware Issue</p> <p>There is a problem with the instrument which has not been acknowledged. Processing cannot start. Press Options > Faults to display the Fault Status screen. Pressing the icon will also open the Fault Status screen. See Using the Fault Status Screen on page 158.</p>

Using the Fault Status Screen

If the wrench (spanner) icon is displayed, this indicates that there is a hardware issue that needs to be addressed before processing can start. You will need to check the Fault Status Screen to find out more information about the issue.

- To display the screen either select **Options > Faults** or press the wrench (spanner) icon.

The Fault Status Screen lists all current warnings and faults and their status:

- A warning (WARN) indicates the presence of an issue that can be acknowledged or resolved by the operator.
- A fault (FAULT) indicates the presence of an issue that may require service intervention.
- To display any warnings or faults that are not listed on the first page, press **Page Down**.
- To view all active and inactive warnings and faults, press **Show All**.

The following information is displayed for each warning and fault:

- Number:** Each warning and fault has a predefined number and is listed in numerical order.
- Status:** Reported as OK, WARN or FAULT.
- Name:** For example, Specific gravity or Reaction Chamber (RC) trip out.
- Last:** The date and time of the last trigger.
- Count:** The number of times that the warning or fault has occurred.

Note

Some warnings, that can be resolved by the operator, have a solution displayed at the top of the screen:

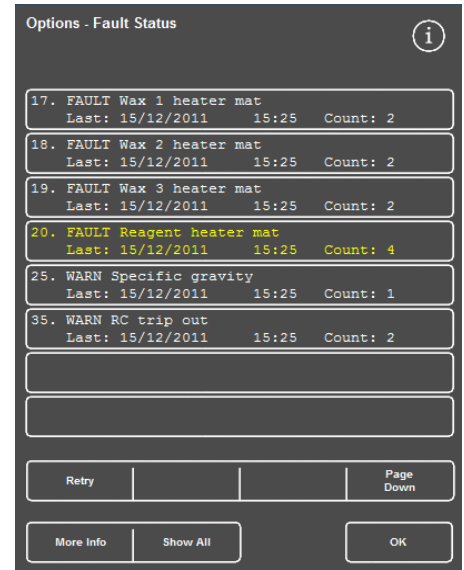

Fault Status Screen

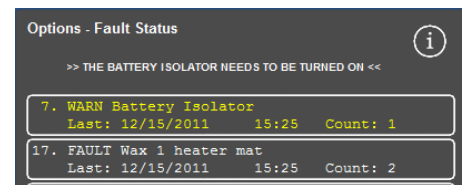

Fault Solution

Acknowledge and Retry

- If the status is WARN, you can select **Acknowledge**.
- If the status is FAULT, you can select **Retry**.

These selections clear the alert icon, and you can try to continue processing. If the problem persists, contact Thermo Fisher Scientific.

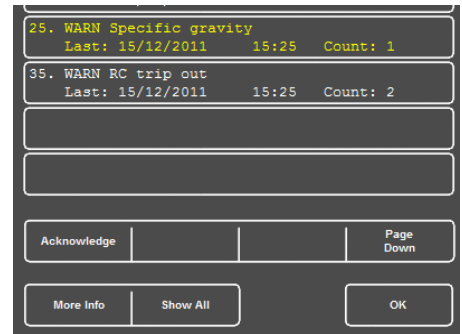

Acknowledge button

More Info

For historical information about a fault, select the fault and press **More Info** to display the Fault Info screen.

This screen provides details of previous occurrences of the fault condition and its current status.

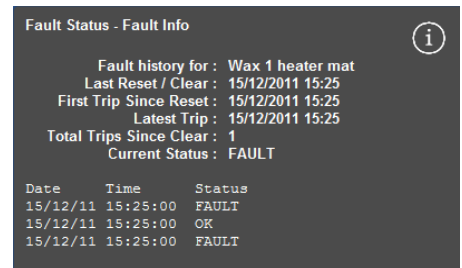

Fault Info screen

Underfills and Recovery

Reaction Chamber underfill and overflow events are also displayed on the fault status screen.

Processing Problems - Soft, Spongy Tissue

Refer to the table below if processing results in soft, spongy tissue.

Note

Excelsior cannot be used for reprocessing.

Problems	Possible Causes	Solutions
<p>Difficult to section. Section breaks up on the water bath. Poor staining.</p>	<p>Inadequate fixation</p>	<p>Increase time in fixative. Use microwave-enhanced technique. Bisect if encapsulated specimen or produce a thinner block.</p> <p>Note <i>Improper fixation cannot be remedied.</i></p>
<p>Clearing impossible. Discoloured cloudy areas within specimen. Section breaks up on water bath.</p>	<p>Inadequate dehydration</p>	<p>Increase time in alcohol. Make sure concentration of alcohol is correct. Adjust solution rotation schedule. Rule out contamination from lipids. Bisect if encapsulated specimen or produce a thinner block. Re-infiltrate in wax. If inadequate, reverse process to absolute alcohol and reprocess.</p>
<p>Wax cannot infiltrate. Discoloured cloudy areas within specimen. Section breaks up on the water bath.</p>	<p>Inadequate clearing</p>	<p>Make sure the specimen is completely dehydrated. Adjust rotation schedule. Increase time in clearant. Use vacuum. Bisect if encapsulated specimen or produce a thinner block. Re-infiltrate in wax. If inadequate, reverse process to absolute alcohol and reprocess.</p>
<p>Can feel or smell clearing solution. No support when sectioned. Section breaks up on the water bath.</p>	<p>Inadequate wax infiltration</p>	<p>Extend exposure time. Use vacuum. Bisect if encapsulated specimen or produce thinner block. Re-infiltrate. Use vacuum to promote infiltration.</p>

Processing Problems - Hard, Brittle Tissue

Refer to the table below if processing results in hard, brittle tissue.

Problems	Possible Causes	Solutions
Obvious drying of all or part of the specimen.	Drying during transport	Use the volume of 20:1 in an appropriately sized container of fixative. Reconstitute the specimen.
Brittle sections that fall out of block. Micro chatter.	Excessive dehydration	Decrease time and/or steps. Check graduated strengths of alcohol. Segregate small, delicate specimens. Do not use heat and/or vacuum. Soak for short time in chilled water and then section slowly. Do not trim away the hydrated area.
	Excessive clearing	Decrease time and/or steps. Evaluate xylene substitutes. Segregate small, delicate specimens. Do not use heat and/or vacuum. Soak for short time in chilled water and then section slowly. Do not trim away the hydrated area.
	Excessive heat	Reduce processing temperature during reagent steps. Decrease time and/or steps. Check temperature reading with thermometer. Segregate small, delicate specimens. Soak for short time in chilled water and then section slowly. Do not trim away the hydrated area.

Frequently Asked Questions

The following frequently asked questions are answered in this section:

- How do I run a process with only one fixative step? – page 163
- How do I drain the Reaction Chamber one level at a time at the completion of a processing run? – page 163
- What is the recommended way to open the lid during a process run? – page 163
- Why is the minimum time in the first wax 10 minutes? – page 163
- How can a step be deleted in a program? – page 164
- How do I change the alcohol quality rotation setting? – page 164
- How can I abort a processing run? – page 164
- How do I power off Excelsior AS correctly? – page 164
- How do I check an underfill? – page 165
- What level is 3.8 litres / 1 gallon (US) in the Reaction Chamber? – page 165
- How can I start a processing run on a step other than step 1? – page 165
- How can I discard a concealed reagent or wax? – page 166
- How can I load new reagent into one of the back (concealed) reagent positions? – page 166
- How can I manually rotate the concealed reagents and wax baths? – page 167
- Does Excelsior AS automatically update for Daylight Savings Time (DST)? – page 167
- What is an alcohol hydrometer and how do I use it to check alcohol percentages? – page 168
- Can I use the flush cycle to clean my embedding base moulds? – page 168
- Why is my quality control usage limit count red instead of green? – page 169
- Why can I not enter values other than zero on my filters in the QC screen? – page 169
- How can I determine when my last reagent rotation occurred? – page 170
- How can I verify that all reagent / wax positions were used during the last processing run? – page 170
- How do I retrieve my tissues if an instrument malfunction occurs while the instrument is under vacuum? – page 171.
- I exited the Inspect Reagents screen while loading reagent into a concealed bottle. How can I finish loading the bottle? – page 171

How do I run a process with only one fixative step?

- From the Main Screen, press **Options > Edit Program**.
The Select a Program screen appears.
- Select the required program.
The Options – Edit Program screen appears.
- Disable the Fixative 2 step by removing the checkmark (tick) from its box.
For details, see Editing a Program or Flush on page 119.

How do I drain the Reaction Chamber one level at a time at the completion of a processing run?

- When processing is complete, press the **Drain Next Level** button.
For details, see Draining the Reaction Chamber on page 68.

What is the recommended way to open the lid during a process run?

- Press the **Lid Release** button.
- Wait until the status message says ‘Lid released’ and then open the lid.
For details, see Stopping a Process on page 66.

Note

*Opening the lid without first pressing **Lid Release** will result in a Lid Open Alarm fault.*

Why is the minimum time in the first wax 10 minutes?

This is to allow sufficient time to heat the surface of the level sensors.

If the surface of the level sensors are not allowed to heat up sufficiently, a covering of wax can be left on them when the Reaction Chamber is drained. This will cause the instrument to register the presence of wax up to the affected level and continue to attempt to drain an already empty chamber.

It takes ten minutes to ensure that the level sensors are all up to temperature.

How can a step be deleted in a program?

Other than for the fixatives, individual steps cannot be removed from a program.

To remove an entire group of reagents (for example, Dehydrant, Clearant or Infiltration):

- Remove the checkmark (tick) from the applicable box.
For details, see Editing a Program or Flush on page 119.

Note

Entering a zero time (00:00) for a step will NOT delete the step. The appropriate reagent will still be drawn into the chamber and then immediately drained.

How do I change the alcohol quality rotation setting?

- From the Main screen, press **Options > Instrument Setup > Rotation Management**.
The Instrument Setup – Rotation Management screen appears.
Use the **A1 Quality Threshold** arrow keys to adjust the rotation threshold up or down in 1.25% intervals.
For details, see Reagent Rotation on page 101.

How can I abort a processing run?

- From the Process Monitoring screen, press **Stop > Abort**.
The Status line will say ‘Aborting Process’ while the Reaction Chamber drains.
Once the chamber is empty, the baskets can be removed and another process started, if required.

Note

It is not recommended to abort a rotation run beyond the fixative step(s). All reagents and waxes should be used in a program when rotations are to take place – otherwise, a scheduled discard or replenishment might not occur.

How do I power off Excelsior AS correctly?

- Ensure that the instrument is not running a process. If it is, wait until the process has completed and then run a flush before powering off.
- Switch off the main power switch, located at the back of the unit, and wait while the instrument powers down.
- When the screen goes blank, wait approximately 10 seconds or until a ‘click’ sound is heard.
It is now safe to turn off the battery switch located in the front cabinet.

How do I check an underfill?

- From the Main screen, press **Quality Control > Inspect Reagents**.
The Quality Control – Inspect Reagents screen appears.
- Select the bottle that you want to inspect from the display on the left of the screen and press **Inspect Reagent**.
The reagent is drawn into the Reaction Chamber. Once this is complete, the reagent can be topped-up by pouring additional reagent directly into the chamber.
- When finished, close the chamber lid and press **Return Reagent**.
- For the precautions that need to be observed before attempting this procedure, see Inspecting reagents and waxes on page 95.



The chamber should be empty when inspecting a reagent.

Ensure that the alcohol positions are topped-up with an appropriate percentage (i.e. a percentage that is close to that recorded during inspection).

The use of an alcohol hydrometer is recommended for accuracy when attempting to determine percentages.

The use of an inappropriate alcohol percentage has the potential to adversely affect processing results.

What level is 3.8 litres / 1 gallon (US) in the Reaction Chamber?

If using 1 gallon (US) bottles, the chamber fluid level reaches mid-way between the second and third level sensors.

Note:

The majority of under-fill problems on Excelsior AS can be eliminated by using 5 litre reagent bottles.

How can I start a processing run on a step other than step 1?

- From the Reaction Chamber Available screen, press the **Start Step** button until the desired step is reached and then press **Immediate Start**.

The selected reagent will be drawn into the Reaction Chamber and the remainder of the process will run as programmed.

Note

A delayed start function is not available when 'step-starting' a process run.

How can I discard a concealed reagent or wax?

- From the Main screen, press **Quality Control > Inspect Reagents**.
The Quality Control – Inspect Reagents screen appears.
- Select the bottle or wax bath that you want to discard from the display on the left of the screen and press **Inspect Reagent**.
The reagent or wax is drawn into the Reaction Chamber.
- Once the reagent or wax has been drawn into the Reaction Chamber, press **Discard** to discard it.

Note

If you are inspecting wax, it needs to remain in the chamber for a minimum of 10 minutes prior to pressing Discard so that the chamber has sufficient time to heat.

- Check that an empty reagent bottle or waste wax tray is in place and press **Confirm Loaded**.
The contents of the chamber drain into the appropriate container.
For details, see Inspecting reagents and waxes on page 95 and Discarding a Reagent after Inspection on page 97.

How can I load new reagent into one of the back (concealed) reagent positions?

- From the Main screen, press **Quality Control > Inspect Reagents**.
The Quality Control – Inspect Reagents screen appears.
- Select the empty bottle that you want to load from the display on the left of the screen and press **Load Reagent**.

Note

*The **Load Reagent** button is only available if the selected bottle is empty. If the selected bottle is full, its contents will need to be inspected and discarded before loading with new reagent.*

- Place the new reagent into the appropriate Exchange position (Ex1 or Ex2) and press **Confirm Loaded**.
The contents of the Exchange bottle will be drawn into the Reaction Chamber and then automatically drained into the applicable concealed reagent position.

How can I manually rotate the concealed reagents and wax baths?

- From the Main screen, press **Quality Control > Inspect Reagents**.
The Quality Control – Inspect Reagents screen appears.
- Select the reagent or wax container that you want to discard from the display on the left of the screen and press **Inspect Reagent**.
The reagent or wax is drawn into the Reaction Chamber.
- Once the reagent or wax has been drawn into the Reaction Chamber, press **Discard** to discard it.

Note

If you are inspecting wax, it needs to remain in the chamber for a minimum of 10 minutes prior to pressing Discard so that the chamber has sufficient time to heat.

- Check that an empty reagent bottle or waste wax tray is in place and press **Confirm Loaded**.
The contents of the chamber drain into the appropriate container.
For details, see Inspecting reagents and waxes on page 95 and Discarding a Reagent after Inspection on page 97.
- To rotate the next reagent or wax in the sequence down to the empty position, select that reagent's image from the display on the left of the screen and press **Inspect Reagent**.
The reagent is drawn into the Reaction Chamber.
- Once the reagent or wax has been drawn into the Reaction Chamber, press **Rotate Reagent**.
The contents of the chamber will drain one position down the reagent or wax line instead of being returned to its original container.
- Continue this process until all reagents or waxes have been rotated appropriately.

Does Excelsior AS automatically update for Daylight Savings Time (DST)?

No, it does not. If located in an area where DST is observed, the time needs to be manually changed.

To change the time:

- From the Main Screen press **Options > Set Time**.
The Options – Set Time screen appears.
- To change the hour, press **Hour**.
The Hour button becomes highlighted in yellow.
- Use the single arrow keys (up or down) to change the time in one-hour increments
- Press **OK** to save the changes.

What is an alcohol hydrometer and how do I use it to check alcohol percentages?

A hydrometer is used to measure the specific gravity of liquids. An alcohol hydrometer measures the specific gravity of alcohol and correlates it to a scale marked on the hydrometer that measures percentage or proof, or both.

To check the alcohol percentage of a concealed dehydrant position:

- From the Main screen, press **Quality Control > Inspect Reagents**.

The Quality Control – Inspect Reagents screen appears.

- Select the bottle that you want to inspect from the display on the left of the screen and press **Inspect Reagent**.

The reagent is drawn into the Reaction Chamber. Once the reagent has been drawn into the Reaction Chamber, a sample can be removed for testing purposes.

For details, see Inspecting reagents and waxes on page 95.

- Pour the sample into a tall (preferably clear) container such as a graduated cylinder.
- Gently lower the hydrometer into the cylinder – allowing it to come to rest.

Note

It is important that the hydrometer floats freely in the sample and does not touch the bottom or sides of the container. Choose a container of suitable size and fill it with an appropriate amount of sample reagent so that the hydrometer floats within it.

- To read the value of the sample, look for the point at which the top of the sample touches the hydrometer and the corresponding point on the hydrometer's percentage / proof scale.

Note:

The majority of under-fill problems on Excelsior AS can be eliminated by using 5 litre reagent bottles.

Can I use the flush cycle to clean my embedding base moulds?

No. It is recommended that the flush cycle be used solely to clean the Reaction Chamber and basket(s). Cleaning base moulds during a flush cycle increases the amount of paraffin in the flush reagents.



Flush reagents can only be used a maximum of five times.

Why is my quality control usage limit count red instead of green?

Red usage limit count: This indicates that the quality control limit has been reached (or exceeded) for that particular reagent or filter. A yellow QC triangle will also be shown in this scenario.

Yellow usage limit count: This indicates that there is one use remaining (or in the case of a filter, one week remaining) until the limit has been reached.

Green usage limit count: This indicates that the count is within the defined use limit period.

To view or edit use limit settings:

- From the Main screen, press **Options > Instrument Setup > Reagent Use Limits**.

The Instrument Setup – Reagent Use Limits screen appears. From here you can view and define the use limits for fixatives, filters and flush reagents.

Why can I not enter values other than zero on my filters in the QC screen?

Counts can only be cleared on filters and flush reagents within the Quality Control screen.

To view or edit use limit settings:

- From the Main screen, press **Options > Instrument Setup > Reagent Use Limits**.

The Instrument Setup – Reagent Use Limits screen appears.

Note

For the flush reagents, use limit settings cannot be increased beyond the default value of five.

If required, fixative counts can be adjusted. For example, if a process run was started and aborted in the first fixative step, you may wish to adjust the Fix1 count in order to more accurately reflect actual usage.

To adjust a fixative count:

- From the Main screen, press **Quality Control > Detailed Information**.

The Quality Control – Detailed Information screen appears.

- Select the required fixative from the display on the left of the screen.

An Adjust Count button appears within the Detailed Information screen.

- Press **Adjust Count**.

The Adjust Count – Fixative Use Count screen appears.

- Enter the required fixative count value and press **OK** to save.

How can I determine when my last reagent rotation occurred?

- From the Main screen, press **Quality Control > Detailed Information**.

The Quality Control – Detailed Information screen appears.

This screen lists all of the concealed reagents and wax baths and for each one shows the loading date, the last rotation date and the number of times that it has been used.

How can I verify that all reagent / wax positions were used during the last processing run?

- From the Main screen, press **Quality Control > Reports > Concise Event Log – View**.

An on-screen report appears that shows a listing of the reagent / wax positions used during a particular processing run, their order of use and the times that each one was drawn into the Reaction Chamber.

Note

The following time periods can be specified for reports:

- *The last run*
- *The last 24 hours*
- *The last 7 days*
- *All data*

Why are my processing results very poor immediately following a reagent rotation?

Check the quality of your new A6 reagent to ensure that the previously discarded A1 waste has not been accidentally reloaded into the instrument:

- From the Main screen, press **Quality Control > Inspect Reagents**.
- Select the A6 bottle by pressing on its image and then press **Inspect Reagent**.

Once the reagent has been drawn into the Reaction Chamber, it can be visually inspected. For more details, refer to Inspecting reagents and waxes on page 95.

Note

If waste has been accidentally reloaded, it should be readily apparent once the reagent is visually inspected. If in doubt, a hydrometer can be used to determine the alcohol percentage. The A6 position should always contain 100% alcohol.

- If it is determined that former A1 waste has been accidentally reloaded, each position from A6 through W3 should be discarded and loaded with fresh reagent / wax. For more details, refer to Discarding a Reagent after Inspection on page 97 and Loading a Reagent or Wax After a Discard on page 98.
- In the event of a xylene rotation only (that is, alcohol did not rotate along with xylene), start by inspecting X3. If it is determined that former X1 waste has been accidentally reloaded, each position from X3 through W3 should be discarded and loaded with fresh reagent / wax.

How do I retrieve my tissues if an instrument malfunction occurs while the instrument is under vacuum?

- Press the Lid Release or Stop / Abort options, if available.
If these options are not available, open the right door, remove the metal baffle plate and pull the red emergency vacuum release. For details, see Fitting the Filters on page 29.
- Remove all specimens from the Reaction Chamber.

I exited the Inspect Reagents screen while loading reagent into a concealed bottle. How can I finish loading the bottle?

- The reagent will be in the Reaction Chamber. To return to the Inspect Reagents screen, from the Main Screen, press **Quality Control > Inspect Reagents**.
- Press **Rotate** to complete loading the reagent to the concealed bottle.

Appendices

The appendices provide additional information about your Excelsior AS instrument.

The following subjects are covered:

- Spares and accessories.
- Fitting optional vent adapters.
- Repacking your instrument after it has been decommissioned.
- Approved reagents.
- Program examples.
- Screen maps showing how the instrument's software menus and options are organised.

Appendix A - Accessories

Accessories Baskets

Item	Quantity	Part Number
Organised basket	6	A78410025
Random basket	1	A78410021
Divider	1	A78420158
Basket lid	1	A78420156
SecureSette segment basket kit	1	A82310071
Organiser Fifty segment basket kit	1	A82310038
Level Sensor cleaning pad	1	A78410095

Extraction Adaptor Kits

Item	Quantity	Part Number
Downdraft Extraction Duct Adapter Kit	1	A82310033
Main Air System Duct Adapter Kit	1	A78410024

Filters

Item	Quantity	Part Number
Vapour filter (carbon)	1	9990610
Carbon	6	7411258
Formaldehyde Filter	1	9990612
Formaldehyde Filter	6	9990612CS

Reagent Bottles and Wax Kits

Item	Quantity	Part Number
5 litre Reagent Bottle (empty)	6	A78410026
Wax Waste Tray	5	8300

Note

A range of tissue processing reagents and wax exchange kits are available from your Thermo Fisher Scientific representative.

General

Item	Quantity	Part Number
Operator Guide	1	A82310100
Service Manual	1	A82310101
Spatula	1	P09046
1GB USB Flash Drive	1	AP17385

Appendix B - Fitting the Optional Vent Adapters

The optional vent adapters allow fumes to be extracted from Excelsior AS into a fume cupboard or hood, or vented to the outside atmosphere.



Do not use the vent adapters to extract the fumes through the building's Heating, Ventilating, and Air Conditioning (HVAC) system or a common site extraction system.

Extraction Vent Adapter

The main air system duct adapter attaches to the vent outlet on the back of the instrument and vents reagent and wax fumes away from the instrument through flexible ducting.



Do not remove the main extraction filters when the extraction vent adapter has been fitted to the instrument.

To fit the extraction vent adapter:

- Fit the extraction vent adapter to the vent outlet on the rear of the instrument with the fixings supplied.
- Attach flexible ducting to the vent adapter and secure with the clip.
- Route the ducting to a vented area.

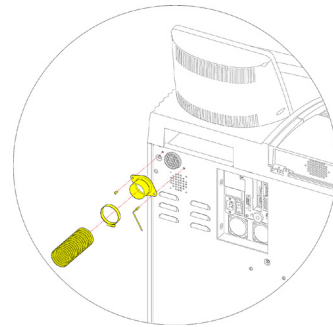

Fitting the extraction vent adapter

Downdraft Extraction Vent Adapter

The downdraft extraction duct adapter kit attaches to the back of the downdraft filter compartment and vents the downdraft airflow away from the instrument through flexible ducting.



Do not remove the main extraction filters when the extraction vent adapter has been fitted to the instrument.

To fit the downdraft extraction vent adapter:

- Open the downdraft filter cover and remove the downdraft filter. The filter should be replaced after the adapter has been fitted.
- Fit the downdraft extraction vent adapter to the back of the instrument using the screws and gasket provided.
- Attach flexible ducting to the vent adapter, secure with the clip and route the ducting to a vented area.

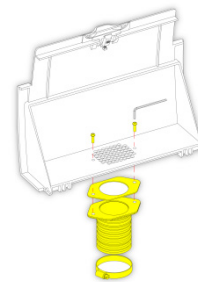

Fitting the Downdraft Extraction Vent Adapter

Appendix C – Repacking Instructions

If the instrument is to be transported, follow these packaging instructions, after unloading ALL reagents and wax and switching the instrument off. For more information, refer to Instrument Shutdown Procedure on page 150 and Unloading Reagents on page 151.



When moving Excelsior AS , use safe lifting practices. Excelsior AS weighs approximately 165 kg (364 lb) when empty.

At least two people are needed to safely move the instrument.

Note

Use ALL original packaging and keep the instrument upright at ALL times.

- Place the base of the packaging in a clear area.
3.5 metres is required in front of the packaging for the ramp and approximately one metre is required behind the packaging.

Note

The wooden piece slots under the plinth.

- Lower the packaging ramp:

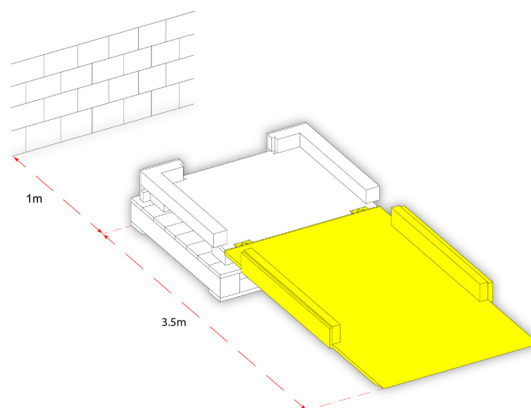

- Fit the handles to the back of the instrument:

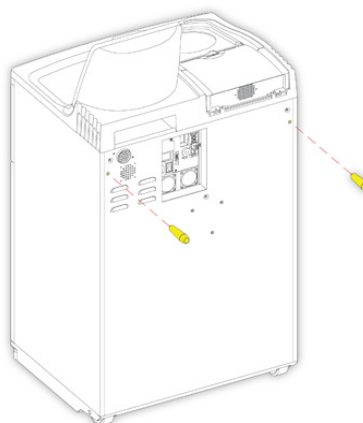

- Carefully wheel the instrument up the ramp until it sits securely in the base:

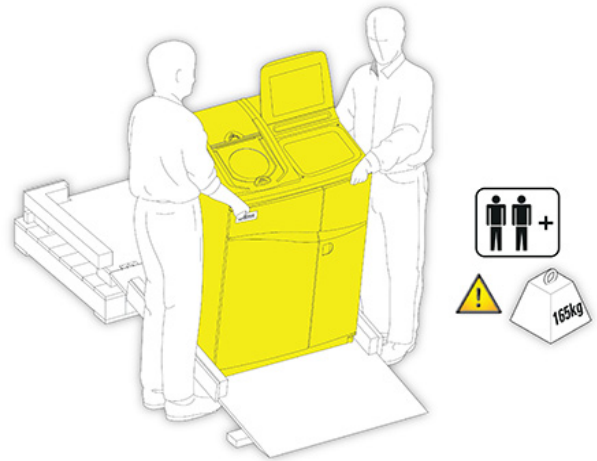

- Remove the handles and secure them at the back of the instrument:

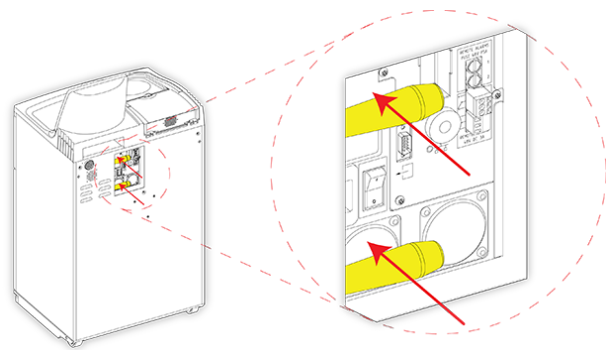

- Put the foam pieces in place:

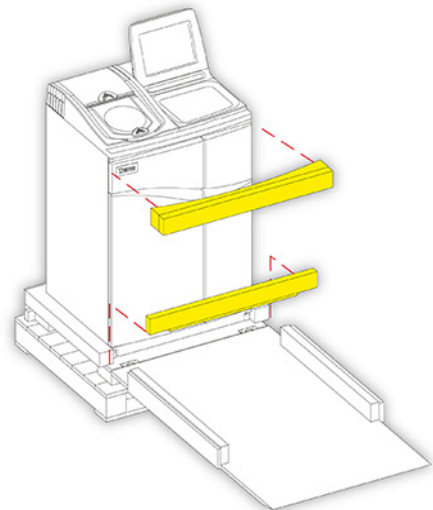

- Raise the ramp:

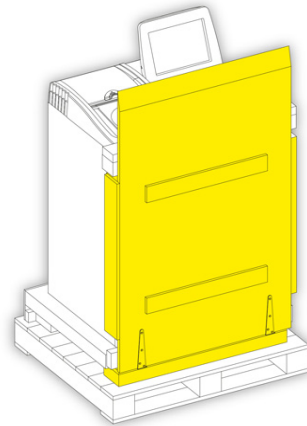

- Fit the outer cover:

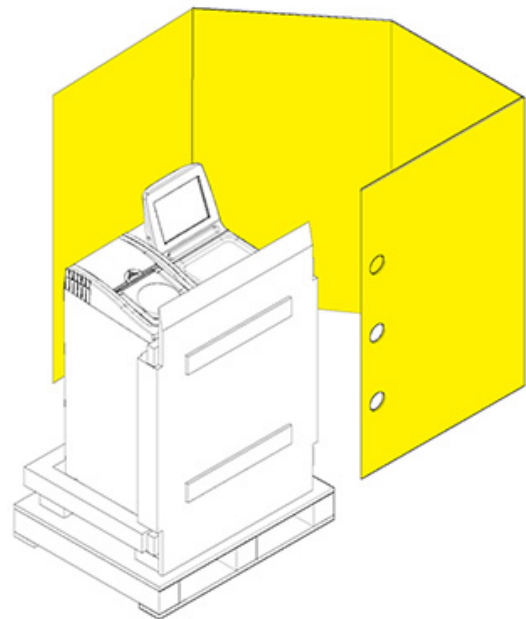

- Turn the three fasteners to secure the outer cover in place:

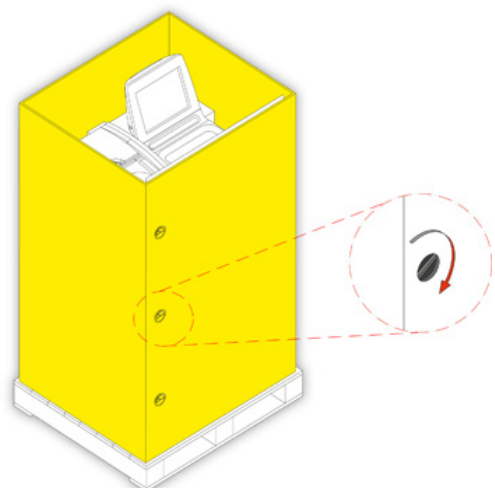

- Fit the lid over the outer cover:

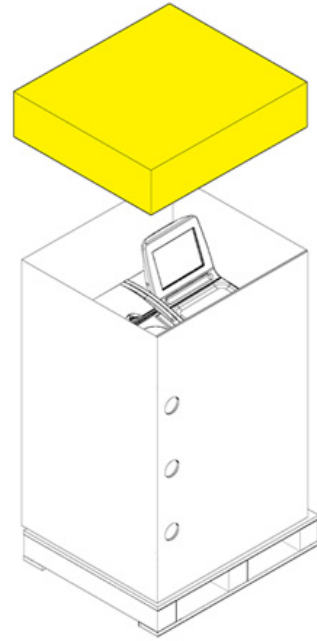

- Secure the packaging using two bands through the pallet and over the lid:

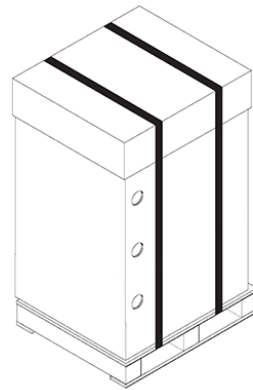

After packaging, ensure that the instrument is kept upright at all times while it is being transported.

Appendix D - Approved Reagents

All the reagents specified by Thermo Fisher Scientific for use with the Thermo Scientific Excelsior AS tissue processor are listed below. If you want to use a reagent not included in this list, contact your Thermo agent for advice.



Do not use Bouin's fixative, acetone, formal saline, or any reagents containing calcium chloride.

Waxes containing DMSO may damage painted surfaces – in particular if the painted surface is scratched.



Refer to the Material Safety Data Sheets when handling the reagents.

Type	Approved Reagents
Fixatives	<ul style="list-style-type: none"> • 10% neutral buffered formalin (phosphate buffers) • Richard-Allan Scientific Pen-Fix
Dehydrants	<ul style="list-style-type: none"> • Ethanol • Reagent grade alcohol (RGA) / industrial methylated spirit (IMS) – up to 5% methanol in ethanol • Isopropyl alcohol • Richard-Allan Scientific Flex 100 (up to 40% methanol in isopropyl alcohol)
Clearants	<ul style="list-style-type: none"> • Xylene • Toluene • Shandon Xylene Substitute • Richard-Allan Scientific Clear-Rite 3
Infiltrants	<ul style="list-style-type: none"> • Shandon Histoplast • Shandon Precision Cut • Richard-Allan Scientific Histoplast PE • Richard-Allan Scientific Histoplast LP • RA Lamb VA5 • Richard-Allan Scientific Type 1, Type 3, Type 6, Type 9, Type L and Type H
Flush	<ul style="list-style-type: none"> • Any of the named clearants (max 65° C) • Any of the named dehydrants • Water
Surface Cleaning	<ul style="list-style-type: none"> • Sodium hypochlorite (10% in water used at ambient temperature)

Appendix E - Program Examples

The tables in this appendix show the default process and flush programs installed on Excelsior AS. They have all been validated.

Routine Overnight

Step	Reagent	Temp (°C)	Time (hh:mm)	Vac	Drain time (sec)	
1	10% Formalin	Amb.	0:30	Off	30	
2	10% Formalin	Amb.	0:30	Off	60	
3	Dehydrant Group (Alcohol)	75%	30	1:00	On	30
4		90%	30	1:00	On	30
5		95%	30	1:00	On	30
6		100%	30	1:00	On	30
7		100%	30	1:00	On	30
8		100%	30	1:00	On	60
9	Clearant Group (Xylene)	30	1:00	On	30	
10		30	1:00	On	30	
11		30	1:00	On	120	
12	Infiltration Group (Wax)	62	1:20	On	120	
13		62	1:20	On	120	
14		62	1:20	On	120	

Daytime Rapids

Step	Reagent	Temp (°C)	Time (hh:mm)	Vac	Drain time (sec)	
1	10% Formalin	Amb.	0:10	Off	30	
2	10% Formalin	Amb.	0:10	Off	60	
3	Dehydrant Group (Alcohol)	75%	30	0:10	On	30
4		90%	30	0:10	On	30
5		95%	30	0:10	On	30
6		100%	30	0:10	On	30
7		100%	30	0:10	On	30
8		100%	30	0:10	On	60
9	Clearant Group (Xylene)	30	0:10	On	30	
10		30	0:10	On	30	
11		30	0:10	On	120	
12	Infiltration Group (Wax)	62	0:10	On	120	
13		62	0:10	On	120	
14		62	0:10	On	120	

Standard Flush Program

Step	Reagent	Temp (°C)	Time (hh:mm)	Vac	Drain time (sec)
1	Flush 1	60	0:20	On	30
2	Flush 2	45	0:03	On	30
3	Flush 3	Amb.	0:02	On	30

Extended Flush Program

Step	Reagent	Temp (°C)	Time (hh:mm)	Vac	Drain time (sec)
1	Flush 1	60	0:30	On	30
2	Flush 2	45	0:05	On	30
3	Flush 3	Amb.	0:02	On	30

Appendix F - Screen Maps

Main Screen

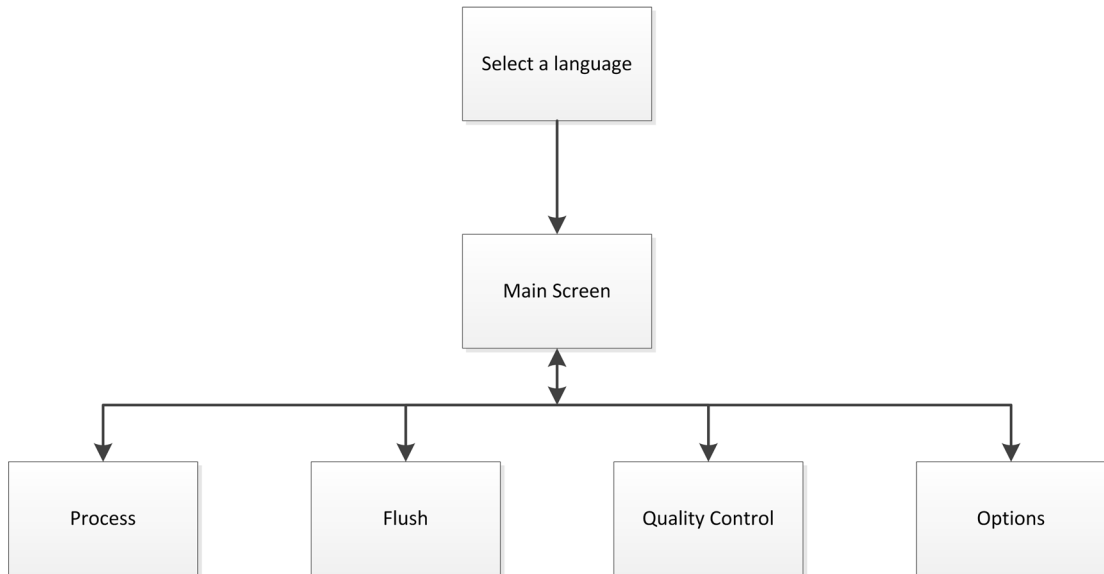

For more information on the Main Screen menu options, see [The Main Screen and Information Bar](#) on page 22.

Process

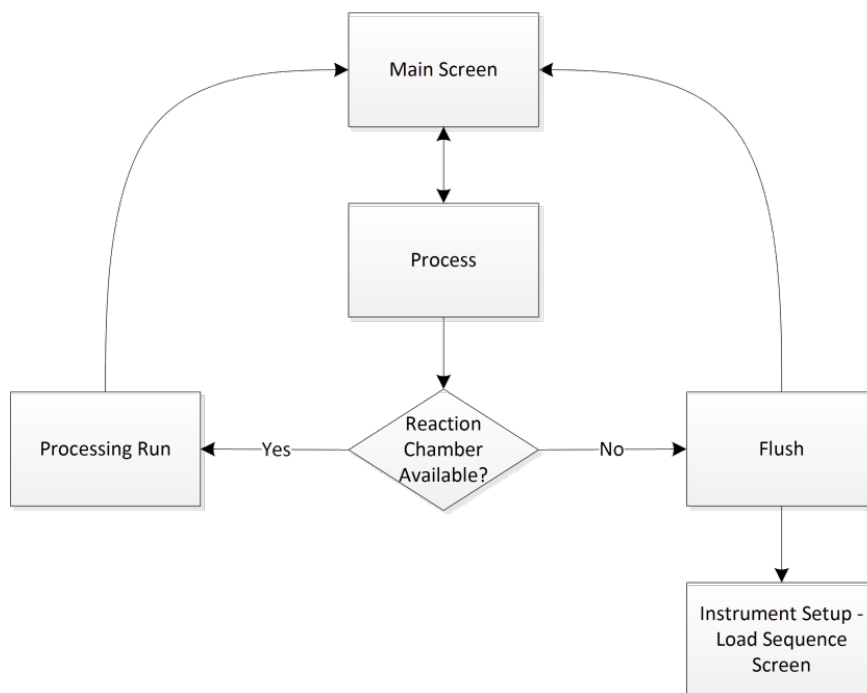

For more information on the processing options, see Routine Processing on page 56.

Flush

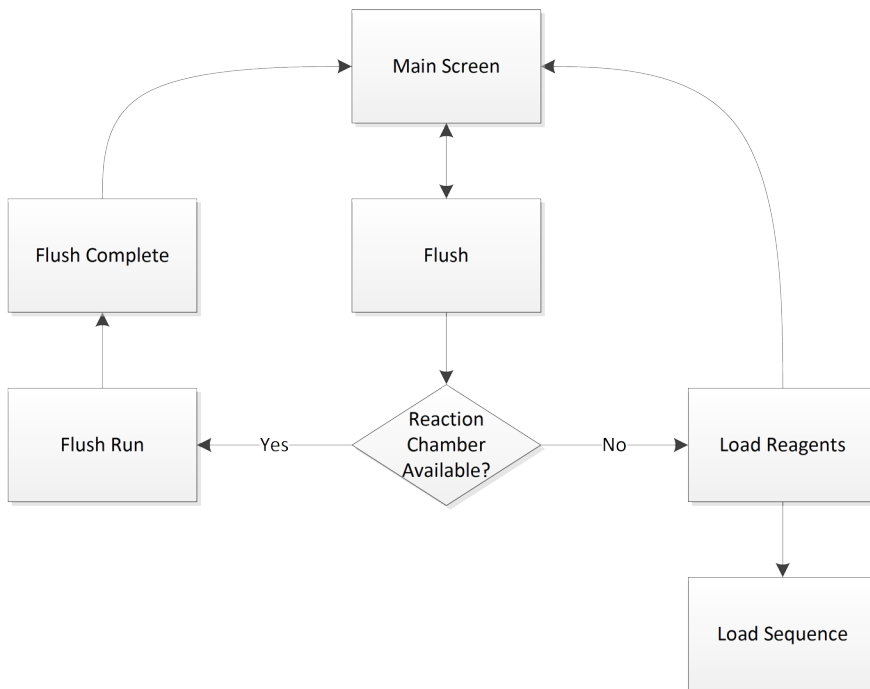

For more information on flush options, refer to the following sections:

- Flushing the Instrument on page 71.
- Loading Reagents on page 43.
- Running the Load Sequence on page 44.

Quality Control

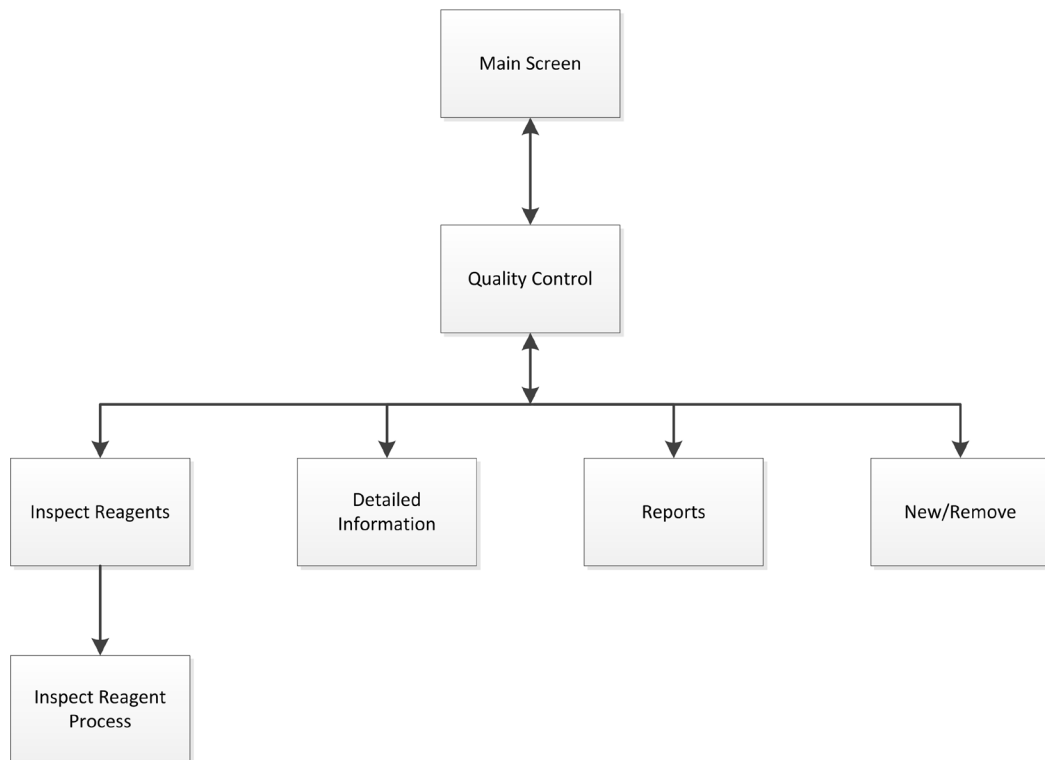

For more information about these menu items, refer to the following sections:

- Quality Control, Filter and Reagent Renewal Limits on page 78.
- Wax Discard and Reagent Rotation Information on page 79.
- Detailed Reagent Information Fields Explained on page 94.

Options

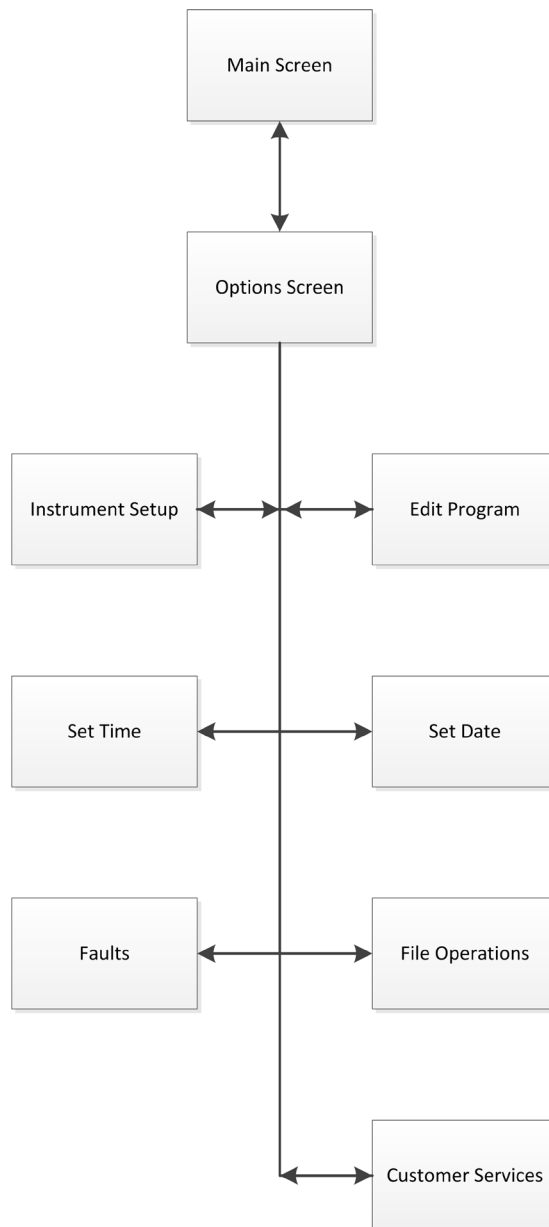

For more information about these menu items, refer to the following sections:

- The Main Screen and Information Bar on page 22.
- Editing a Program or Flush on page 119.
- Setting the System Time and Date on page 37.
- Using the Fault Status Screen on page 158.
- File Operations on page 132.
- Customer Services on page 141.

Options – Instrument Setup



For more information about these menu items, refer to the following sections:

- Defining Reagent Names on page 39.
- Setting Reagent Storage Temperatures on page 40.
- Loading Reagents on page 43.
- Customisation and Workflow on page 107.
- Reagent Rotation on page 101.
- Setting Use Limits on page 42.
- Access Code Protection on page 125.
- Audio and Remote Alarms on page 130.
- Language on page 140.
- Unloading Reagents on page 151.
- Concept Demonstration on page 106.
- Setting Laboratory Information Management System (LIMS) on page 140.

Index

Abort.....	67
Access Codes	125
Setting	128
Access Codes Icon	156
Accessories.....	174
Advanced Operation.....	91
Advanced Processing	72
Changing Delay Settings.....	76
Changing Delay Step	77
Changing End Time	74
Changing Parameters	73
Changing Start Step	75
Process Selection	72
Air Extraction Filters	29
Alarms	130
Audio.....	130
Displaying Events	130
On Hold Setting.....	107
Remote	130
Repeat.....	130
Setting	130
Sounds	130
Alcohol Quality Gauge.....	87, 101, 104
Alerts.....	155
Fault Status Screen	158
Icons	156
Appendices	173
Approved Reagents.....	181
Audio / Remote Alarms Option.....	130
Audio Alarms	130
Available Until	109
Basic Operation.....	55
Baskets	
Loading.....	57
Spares and Accessories	174
Types.....	174
Unloading	67
Battery	
Icon.....	156
Battery Icon	156
Battery Isolation Switch	35, 150
Battery Isolation Switch Icon	156
Blank Screen	107
Cabinet Doors Open Icon	156
Cassettes	
Baskets	174
Loading	57
Changing	
Fill Level.....	59
Filters	149
Instrument Settings	107
Language	140
Number of Baskets	64
Program Parameters.....	73
Reagent Names.....	39
Reagents	80, 82, 83
Rotation Triggers	101
Storage Temperature	40
Workflow Options	107
Checks.....	145, 150
Cleaning	143
Daily	145
Dip Tubes	147
Display	149
Flush 3	148
Reaction Chamber.....	69
Reagent Dip Tubes.....	147

Reagent Supply Bottles.....	147	Setting Instrument Id	107
Safety	144	Shift Start and End.....	107
Spillages	145	Workflow Setup	107
Wax Baths.....	146	Customisation Option	107
Weekly.....	145	Daily Cleaning.....	145
Cleaning (Flush) Reagents		Date	
Approved	181	Format	37
Loading.....	47	Setting.....	37
Unloading.....	151	Daytime Program	
Cleaning and Maintenance.....	143	Selecting.....	72
Clearants		Setting.....	109
Approved	181	Starting.....	60
Discarding	95	Default Program	
Inspecting	95	Changing.....	109
Loading.....	50	Day - Night.....	109
Name	39	Setting.....	109
Renewing.....	83	Starting.....	60
Requesting Rotation.....	104	Dehydrants	
Rotating.....	83	Approved.....	181
Storage Temperature	39, 40	Discarding.....	95
Unloading.....	151	Inspecting.....	95
Completing		Loading	49
Program	67	Name	39
Concept Demonstration	106	Renewing	83
Configure Reagents	39, 92	Requesting Rotation	104
Connecting		Rotating	83
Mains Power	31	Storage Temperature	39, 40
Remote Alarms.....	32	Unloading	151
Vent Adapters	176	Delay Settings	
Customer Text	107	Changing.....	73, 76
Customisation	107	Pressure	76, 77
Adding Customer Text	107	Temperature.....	76
Enabling Level Key	107	Delay Step	
On Hold Alarm	107	Changing.....	73, 77
Option.....	107	Delayed Start	60
Restart Level	107	Detailed Information Option.....	94

Dip Tubes	Access Codes	126
Cleaning	Audio and Remote Alarms.....	130
Colour-Coding	Level Key.....	107
Disabling	End Time	73
Level Key	Changing.....	74
Discard Wax	Preferred.....	109
Acknowledging	Environment.....	19
Postponing.....	Environmental Specification	19
Requesting	Excelsior AS	
Discarding	Advanced Processing.....	72
Used Reagents.....	Approved Reagents	181
Used Wax	Cassettes	174
Display	Date and Time	37
Cleaning	Decommissioning.....	26, 151
Language.....	Electrical Specification.....	18
Locking.....	Environmental Specification.....	19
Unlocking.....	Fuses	19
Disposal	Help	21
Batteries	Intended Use	16
Downdraft Extraction Vent Adapter.....	Interface Connections.....	18
Downdraft Filter	Levelling.....	27
Fitting.....	Mechanical Specification	18
Replacing	Menus	184
Use Limits.....	Moving.....	26
Drain	Overview	16
Levels.....	Positioning	27
Reaction Chamber	Purpose	16
Stopping a Program	Routine Processing	56
Drain Time	Setup.....	35
Setting and Changing.....	Shutdown.....	150
Viewing.....	Specifications.....	18
Ducting.....	Startup	35
Edit Program Option	Touch Screen	149
Electrical Safety	Unpacking.....	26
Electrical Specifications	Extraction Vent Adapter	176
Enabling	FAQs	162

Fault Status Screen	61, 158	Name	39
File Operations.....	132	Replacing.....	80
Load Programs	134	Unloading	151
Save Programs	133	Use Limit	42
Fill Level		Fluid Level	
Adding Additional Specimens	64	Draining.....	68
Draining	68	Level Key.....	59
Restarting a Program.....	66	Selecting.....	59
Selecting.....	59	Flush (Cleaning) Reagents	
Setting	59	Alerts.....	82
Starting a Program	59	Approved.....	181
Wax	45	Loading	47
Filters		Renewing	82
Air Extraction	29	Replacing.....	82
Changing.....	29, 149	Unloading	151
Downdraft	29, 30	Flush 1	
Fitting.....	29	Detailed Information.....	94
Instrument Setup	29, 176	Discarding.....	95
Quality Control	78	Inspecting.....	95
Removing	29	Loading	47
Status	92	Renewing	82
Use Limits.....	42	Replacing.....	82
Fitting		Unloading	151
Air Extraction Filter	29	Use Limit	42
Downdraft Extraction Vent Adapter	176	Flush 2	
Downdraft Filter.....	30	Detailed Information.....	94
Extraction Vent Adapter	176	Discarding.....	95
Flush Bottles	47	Inspecting.....	95
Waste Wax Tray	45, 146	Loading	47
Fixatives		Renewing	82
Alerts	80	Replacing.....	82
Approved	181	Unloading	151
Detailed Information	94	Use Limit	42
Discarding	95	Flush 3	
Inspecting	95	Cleaning.....	148
Loading.....	52	Detailed Information.....	94

Discarding	95	Guided Load Sequence	43
Inspecting	95	Hardware Issue Icon	156
Loading.....	47	Heater Reset Switch.....	35, 150
Refilling	148	Help	21
Refitting.....	148	Immediate Start	60
Removing	148	Infiltrant	
Renewing	82	Approved Reagents.....	181
Replacing	82	Cleaning.....	146, 151
Unloading.....	151	Loading	45
Use Limit.....	42	Name	39
Flush Button	71	Storage Temperature	39, 40
Flush Reagents		Unloading	151
Name.....	39	Inspect Reagents Option.....	95
Use Limit.....	42	Inspecting	
Flush Steps		Reagents.....	95
Changing	119	Wax.....	95
Viewing.....	112	Installation.....	25
Flushes	111	Instrument	
Changing	119	Customisation	107
Changing Parameters	73	Id 107	
Creating.....	116	Malfunctions	160
Drain Time.....	123	Menus	184
Editing.....	119	Positioning	27
Loading.....	134	Repacking.....	177
Name.....	119	Setup	27, 35
Saving	133	Troubleshooting.....	160
Step Pressure Setting	122	Instrument Id	107
Step Time	121	Instrument Setup	
Step Usage Temperature	120	Access Codes	125
Viewing.....	112	Audio / Remote Alarms	130
Flushing		Concept Demonstration	106
After Processing	70	Configure Reagents	92
Option.....	71	Customisation	107
Frequently Asked Questions	162	Initial Setup.....	27
Fuses	19, 150	Language Select	140
General Safety	4	Load Reagents	43

Reagent Storage Temperature	40	Flush (Cleaning) Reagents	47
Reagent Use Limits	42	Flushes	134
Rotation Management	101	Guided Load Sequence	43
Set Date	37	Programs	134
Set Time	37	Reagents	43, 92
Unload Reagents	151	Samples	57
Intended Use Statement	16	Setup	139
Interface		Specimens.....	57
Connections.....	18	Wax.....	45
Introduction.....	15	Location	27
Issues.....	160	Lock	149
Language		Mains Power Failure Icon	156
Changing	140	Mains Power Supply	4
Setting	35	Maintenance	143
Language Select Option.....	140	Filters	149
Language Selection	35	Fuses	150
Legal Information.....	3	Regular Checks.....	150
Level		Maintenance Contract	4
Disabling	107	Malfunctions	160
Enabling	107	Mechanical Specifications	18
Using	59	Menus	184
Levelling Instrument	27	Monitoring	
Lid		Process.....	62
Checks	150	Status	62
Lid Release.....	64, 67	Moving.....	26
Load Programs Option	134	Next Day	74
Load Reagents	92	No Delay	74
Load Reagents Option	43	On Hold Alarm	107
Load Setup Option.....	139	Options	
Loaded	94	Configure Reagents	39, 92
Loading		Customisation	107
Baskets	57	Edit Program.....	111
Cassettes	57	Faults	158
Clearants	50	Instrument Setup.....	107
Dehydrants	49	Language Select	140
Fixatives	52	Load Reagents	43

Reagent Storage Temperature	39, 40	Status	62
Unload Reagents	151	Stopping.....	66
Overnight Program		Program Examples	182
Setting	109	Program Step Parameters	111
Starting	60	Drain Time	123
Overview	16	Pressure Setting	122
Packaging	26	Program Name	119
Positioning	27	Setting and Changing.....	120
Postponing		Step Time.....	121
Rotation.....	86	Usage Temperature	120
Wax Discard	86	Program Steps	
Power	31	Changing.....	120
Preferred End Time.....	109	Disabling.....	119
Previous Day	74	Monitoring.....	62
Problems		Viewing.....	112
Instrument	160	Programs	
Processing	160, 161	Aborting.....	67
Troubleshooting.....	155	Available Until	109
Process Status	62	Changing Parameters.....	73
Processing		Changing Step Parameters.....	120
Aborting	67	Completing	67
Advanced	72	Creating	116
Changing Parameters	73	Drain Time	123
Completing.....	67	Editing	119
Draining	66	Level Key.....	59
Failing to Start	61	Loading.....	134
Instrument Faults.....	61	Name	119
Level Key	59	Parameters.....	120
Monitoring	62	Preferred End Time.....	109
Problems.....	160, 161	Restarting.....	66
Quality Control Checks	61	Saving.....	133
Refilling	66	Selecting.....	72
Restarting.....	66	Setting Daytime	109
Routine.....	56	Setting Default	109
Selecting.....	72	Setting Overnight.....	109
Starting	60	Start Type	124

Starting.....	60	Approved.....	181
Status.....	62	Configuring.....	92
Step Pressure Setting.....	122	Detailed Information.....	94
Step Time.....	121	Discarding.....	95
Step Usage Temperature.....	120	Guided Load Sequence.....	43
Stopping.....	66	Inspecting.....	95
Viewing.....	112	Loading.....	43, 47, 49, 50, 52, 92
Purpose.....	16	Loading Wax.....	45
Push-to-Test Switch.....	150	Renewing.....	78, 80, 82, 83
Quality Control		Requesting Rotation.....	104
Detailed Information.....	94	Safety Information.....	4
Fixatives.....	80	Storage Temperature.....	40
Flush Reagents.....	82	Symbols.....	7
Inspecting Reagents.....	95	Unloading.....	151
Process Start.....	61	Refill.....	66
Reports.....	99	Refill and Restart.....	64
Quality Control Alert Icon.....	156	Refilling	
Quality Control Screen.....	61	Flush 3.....	148
Reaction Chamber		Regular Maintenance Checks.....	150
Cleaning.....	67, 69	Remote Alarm Icon.....	156
Draining.....	68	Remote Alarms	
Flushing.....	67, 70, 71	Connecting.....	32
Reaction Chamber Heater Trip Icon.....	156	Overview.....	130
Reagent		Using.....	130
Dip Tubes.....	147	Removing	
Reagent Names.....	39	Flush 3.....	148
Reagent Rotation.....	87	Renewing	
Reagent Storage Area		Fixatives.....	80
Checks.....	150	Flush 1.....	82
Spillages.....	145	Flush 2.....	82
Reagent Storage Temperature.....	39, 40	Flush 3.....	82
Reagent Supply Bottles		Flush Reagents.....	82
Cleaning.....	147	Repacking.....	177
Reagent Usage		Replacement Parts.....	4
Reports.....	99	Replacing	
Reagents		Clearants.....	83

Dehydrants	83	Programs	133
Filters.....	149	Setup.....	139
Fixatives	80	Screen	
Flush Reagents	82	Cleaning.....	149
Fuses	150	Locking and Unlocking.....	149
Infiltrants	83	Screen Map.....	184
Reports.....	99	Screensaver	107
Reports Option	99	Selecting	
Restart.....	64	Flush	71
Restart Level.....	107	Process.....	72
Restart Process.....	66	Program	72
Restart Program.....	66	Workflow Options	109
Restore Defaults	73	Service Contracts	4
RoHS Directive.....	4	Set Access Codes Option	125, 126, 128
Rotated.....	94	Set Date Option	37
Rotation	87, 101	Set Time Option.....	37
Management	101	Setting	
Postponing.....	86	Access Codes	128
Reagents.....	83, 87	Advanced Processing Options.....	73
Requesting	104	Customisation Options	107
Wax	83	Date	37
Rotation Management Option	101	Daytime Program	109
Safety		Default Program.....	109
Cleaning	144	Fill Level.....	59
Information	4	Fluid Level	59
Samples		Flush Parameters	111, 119
Adding Additional	64	Language	35, 140
Advanced Processing	72	On Hold Alarm.....	107
Loading.....	57	Overnight Program.....	109
Processing Problems.....	160, 161	Preferred End Time.....	109
Routine Processing.....	56	Program Parameters.....	111, 119
Unloading.....	67	Reagent Names.....	39
Save Programs Option	133	Rotation Triggers	101
Save Setup Option.....	139	Shift Times.....	107
Saving		Storage Temperature	40
Flushes	133	Time	37

Workflow Options.....	109	Viewing.....	112
Working Week.....	109	Steps	
Setup.....	25	Disabling.....	119
Access Codes.....	125	Monitoring.....	62
Alarms.....	130	Viewing.....	112
Date.....	37	Stop Button.....	66
Flushes.....	111	Stopping	
Instrument.....	35, 107	Program.....	66
Loading Reagents.....	43	Storage Temperature	
Programs.....	111	Changing.....	40
Time.....	37	Setting.....	40
Workflow.....	109	Storage Temperatures.....	39
Shift End.....	107	Supply Bottle	
Shift Patterns.....	107	Dip Tubes.....	147
Shift Start.....	107	Symbols.....	7
Shutdown Procedure.....	150	System Specifications.....	18
Spares.....	174	Time	
Specifications.....	18	12 or 24.....	37
Specimens		End.....	74
Adding Additional.....	64	Left.....	62
Advanced Processing.....	72	Preferred End.....	109
Loading.....	57	Remaining.....	62
Processing Problems.....	160, 161	Setting.....	37
Routine Processing.....	56	Start.....	60, 62
Unloading.....	67	Step.....	112, 121
Spillages.....	145	Time Left.....	62
Start Process Options.....	109	Total Use.....	94
Start Step		Touch Screen	
Changing.....	75	Cleaning.....	149
Starting		Locking.....	149
Excelsior AS.....	35	Unlocking.....	149
Flushes.....	71	Troubleshooting.....	155
Programs.....	60	Alert Icons.....	158
Status.....	62	Fault Status Screen.....	158
Step Time		Frequently Asked Questions.....	162
Setting and Changing.....	121	Instrument Malfunctions.....	160

Processing Problems.....	160, 161	Warnings.....	4, 7
Unload Reagents Option.....	151	Waste Wax Tray.....	45, 146
Unloading		Wax	
Flush Reagents.....	151	Detailed Information.....	94
Reagents.....	151	Discard.....	83
Samples.....	67	Discarding.....	95
Specimens.....	67	Discarding Used.....	146
Wax.....	151	Inspecting.....	95
Unlock.....	149	Loading.....	45
Unpacking.....	26	Requesting Discard.....	104
Usage Temperature.....	111	Storage Temperature.....	40
Setting and Changing.....	120	Unloading.....	151
Viewing.....	112	Waste.....	146
Use Count.....	94	Waste Wax Tray.....	45
Use Limit.....	94	Wax Bath 3	
Use Limits.....	42	Cleaning.....	146
Used Wax		Wax Baths	
Discarding.....	146	Checks.....	150
User Interface		Cleaning.....	146
Help.....	21	Heaters.....	45
Vacuum Setting.....	111	Loading.....	45
Delay Step.....	76	Used Wax.....	146
Flush Step.....	112	Waste Wax Tray.....	45, 146
Program Step.....	112	Wax Storage Temperature.....	40
Setting and Changing.....	122	WEEE Directive.....	4
Viewing.....	112	Weekly Cleaning.....	145
Vent Adapters.....	174	Workflow Setup Option.....	107, 109
Downdraft Extraction Vent Adapter.....	176	Working Week.....	109
Extraction Vent Adapter.....	176	Xylene-free Processing.....	111

