

GX-A Series / GF-A Series Communication Manual

En Ver. 1.01

Table of Contents

1. Introduction	3
1-1. Applicable models	3
1-2. Features of the communication function.....	3
2. Interface specifications	4
2-1. RS-232C	4
2-2. USB	5
3. Connection diagrams	6
3-1. Connecting the balance to the printer	6
3-2. Connecting the balance to the external display unit.....	6
3-3. Connecting the balance to a PC or a PLC.....	7
4. Connecting to the printer	10
5. Connecting to the external display unit	11
6. Connecting to a PC or a PLC	12
6-1. Quick USB mode	12
6-2. Virtual COM mode	12
6-3. RS-232C	13
6-4. Data transmission software WinCT.....	13
7. Data output	14
7-1. Data output mode.....	14
7-2. Weighing data format	16
7-3. Output examples of weighing data format	19
7-4. Other data formats	20
8. Commands	21
8-1. Control commands	21
8-2. The <AK> code and error codes	24
8-3. Command usage examples	25
9. Error codes	30
9-1. Error codes list	30
10. The UFC function	32
10-1. UFC program commands	32
10-2. Examples of creating UFC program commands.....	34
11. Internal settings	35
11-1. How to set.....	35
11-2. List of items (communication entries only)	37

1. Introduction

This communication manual is a supplementary instruction manual for connecting the balance to peripheral devices such as PCs and printers through the use of its communication function.

1-1. Applicable models

Models to which the contents of this communication manual is applicable are as follows.

□ GX-A Series

GX-1603A, GX-1003A, GX-603A, GX-403A, GX-303A, GX-203A

GX-10002A, GX-6002A, GX-4002A, GX-3002A, GX-2002A

GX-10001A, GX-6001A

□ GF-A Series

GF-1603A, GF-1003A, GF-603A, GF-403A, GF-303A, GF-203A

GF-10002A, GF-6002A, GF-4002A, GF-3002A, GF-2002A

GF-10001A, GF-6001A

1-2. Features of the communication function

- The RS-232C interface is provided as standard, enabling communication similar to conventional balances.
- A USB interface is provided as standard and you can select between a quick USB for inputting the weighing result directly into the PC software or bidirectional communication using a virtual COM port.
- By using the GXA-03: RS-232 C interface isolation type, which is a specialized option, an RS-232C interface can be added.

2-2. USB

Connector: miniB (female)
Standard: USB 2.0
Device class: HID (Human interface device) : Quick USB
CDC (Communication device class) : Virtual COM

miniB, pin arrangement

Pin No.	Signal name	Direction	Meaning, remarks
1	VBUS	Input	Power (connection confirmation)
2	D-	-	Data transmission and reception
3	D+	-	Data transmission and reception
4	ID	-	N.C.
5	GND	-	Signal ground

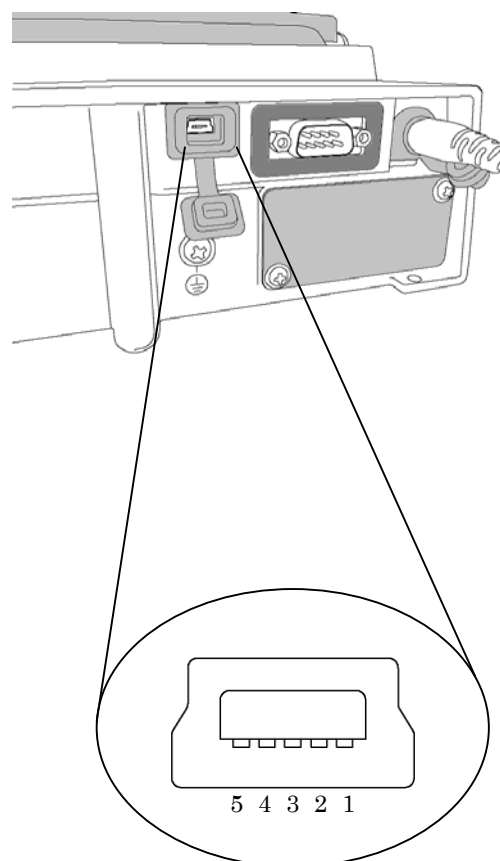

3. Connection diagrams

It is possible to connect the balance to peripheral devices, PCs, PLCs, etc. by using the RS-232C connector and the USB miniB connector which are provided as standard with the balance.

3-1. Connecting the balance to a printer

To print the weighing result measured with the balance on paper, connect a specialized balance printer (e.g. AD-8127 Compact Printer) to the device.

- Connect the balance with the printer using the RS-232C cable.
For settings when connecting the balance to the printer, refer to section 4, "Connecting to the printer".

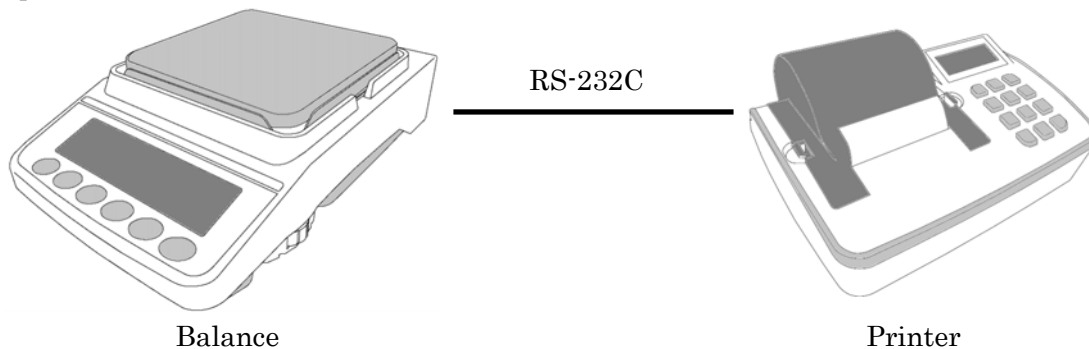

3-2. Connecting the balance to an external display unit

When confirming the weighing values or operating the balance with keys remotely, connect the specialized external display unit to the balance. The specialized external display unit consists of the external display unit AD-8920A (display only) and the external controller AD-8922A.

- Connect the balance to the external display unit using the RS - 232C cable.
For settings when connecting the balance and the external display unit, refer to section 5, "Connecting to the external display unit".

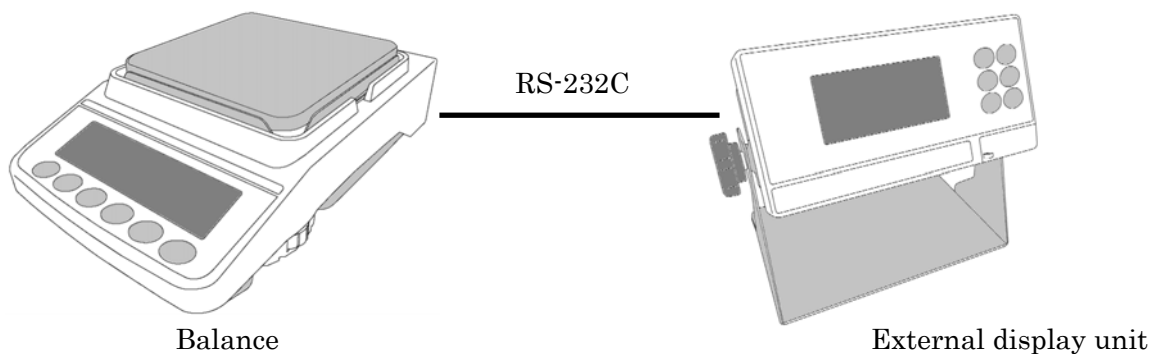

- When connecting the balance to an external display unit and a printer, connect the balance with the external display unit (external controller AD-8922A only) with a RS-232C cable and connect the external display unit and the printer with a RS-232C cable.

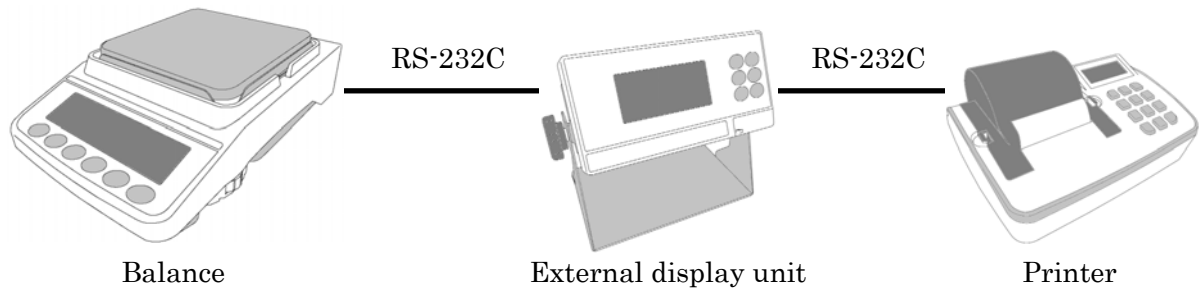

3-3. Connecting the balance to a PC or a PLC

When converting the weighing values of the balance into electronic data or when remotely controlling the balance, connect it to a PC or a PLC.

- Connect the balance to a PC using a USB or an RS-232C cable.

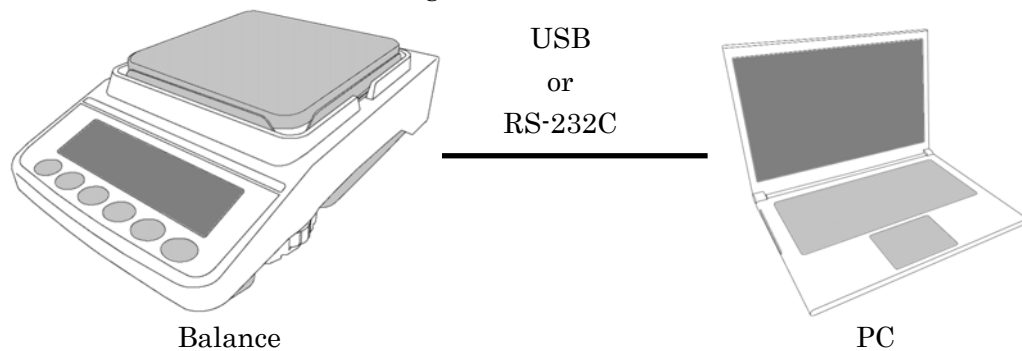

- Connect the balance to a PLC using a RS-232C cable.

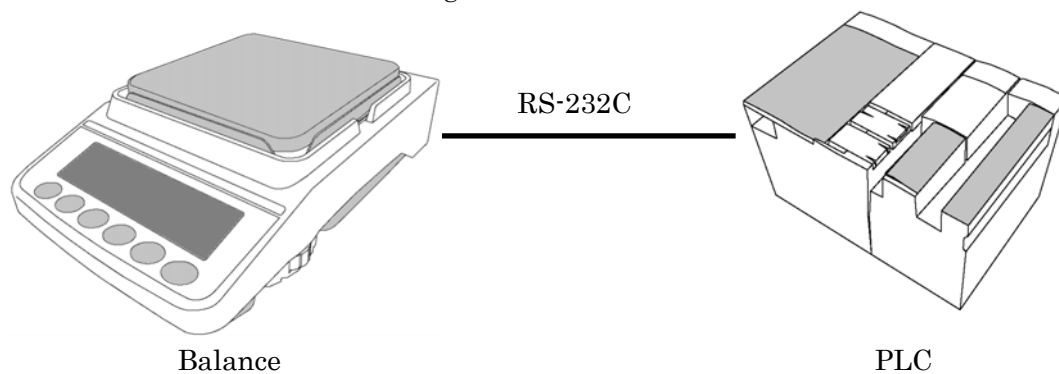

- When connecting the balance to a PC and a printer, connect the balance to the PC with a USB cable and connect the balance to the printer with an RS-232C cable.

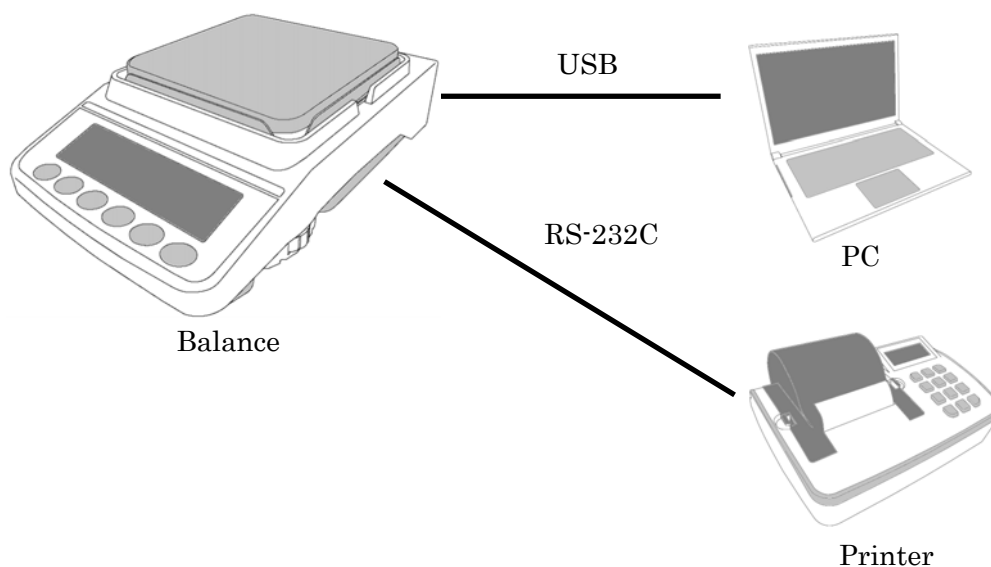

- When connecting the balance to a PC and to the external display unit, connect the balance to the PC with a USB cable and connect the balance to the printer with an RS-232C cable.

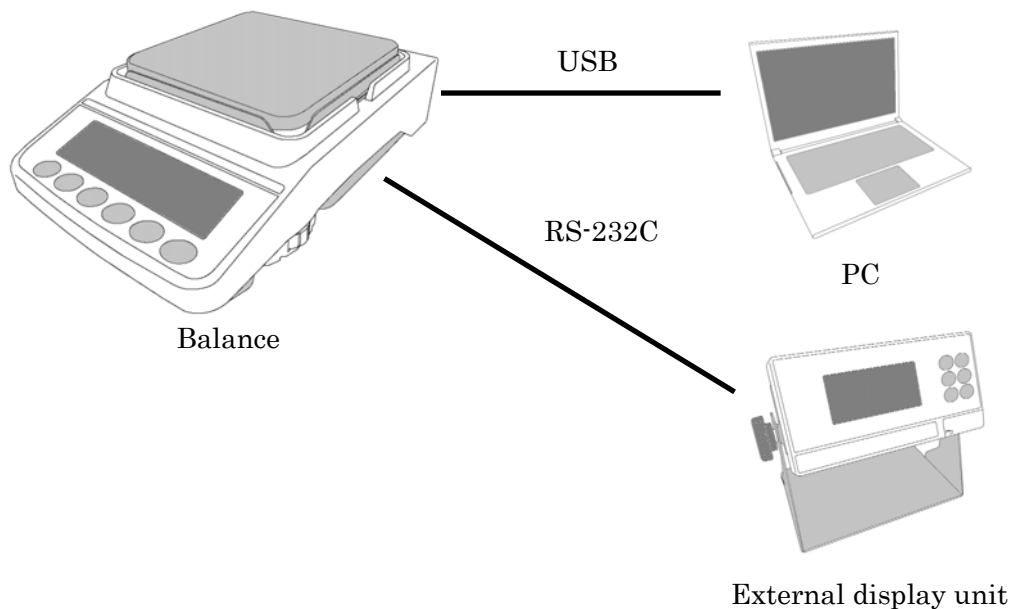

- When connecting the balance with a PLC and the printer or the external display unit, in both cases you must use RS-232C cables. When the balance is equipped with the GXA-03 special option (2nd RS-232C cable, insulated type), connect the PLC with a cable to the RS-232C connector of the GXA-03, and connect the printer or the external indicator unit with a cable to the standard RS-232C connector of the balance.

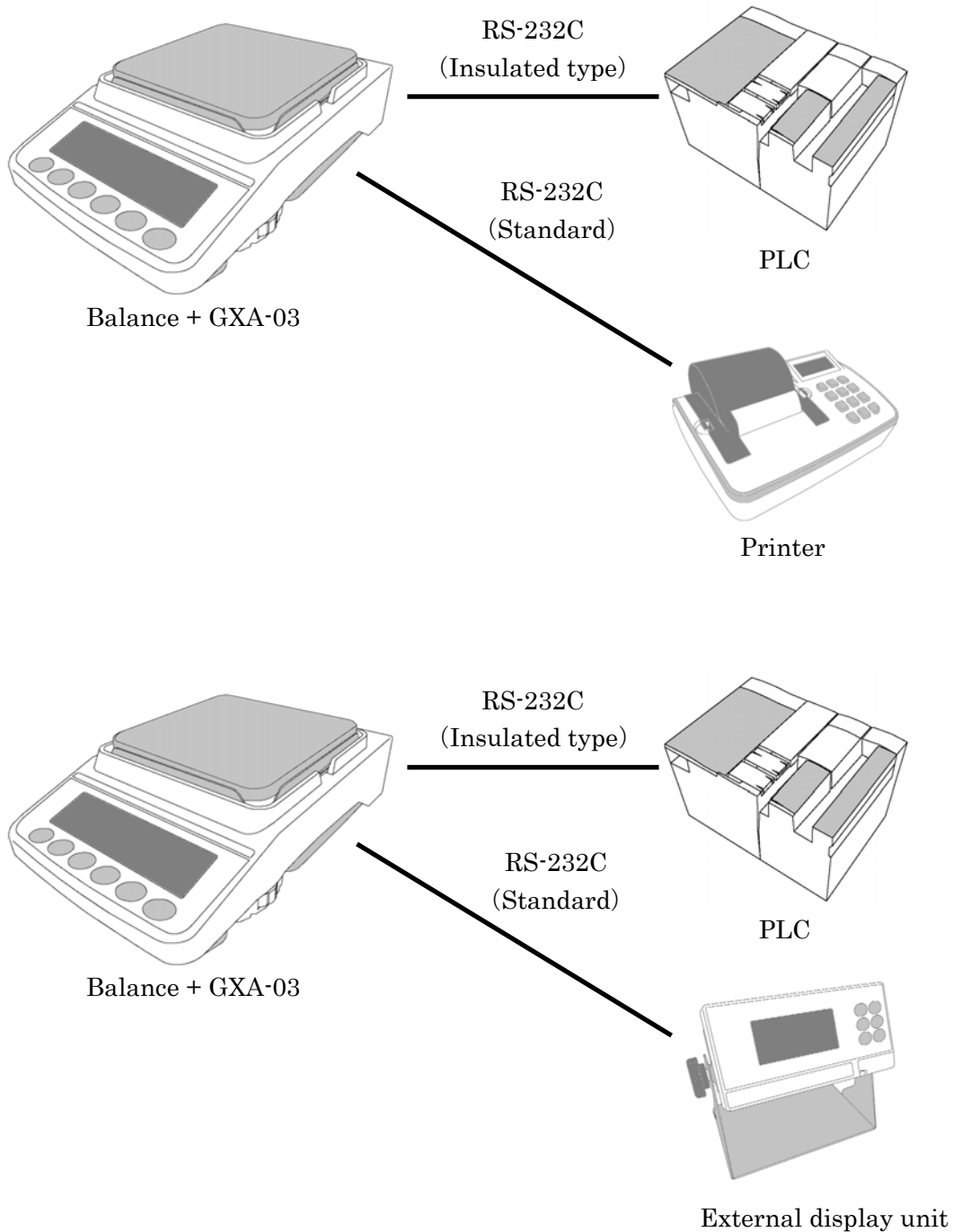

4. Connecting to the printer

When connecting the printer to the balance for printing measured values, configure the printer and the balance as follows according to these usage examples.

Internal settings of the printer

Usage example	AD-8127 Compact printer Printing mode settings
When printing values measured by the balance with the balance's PRINT key or its "Auto-print" mode.	EXT.KEY
When printing values measured by the balance with the printer's "Printing" key or its timer mode. When printing charts with the printer.	MANUAL AUTO TIMER CHART
When printing the balance's statistical calculation results. When printing the balance's GLP data output.	DUMP

- Refer to the instruction manual of the AD-8127 for how to change internal settings of the AD-8127 compact printer.

Internal settings of the balance

Usage example	Balance <i>ModE</i> Connection destination	Balance <i>PrE</i> Data output mode	Balance <i>TYPE</i> Data format
When printing values measured by the balance with the balance's PRINT key or its "Auto-print" mode.	1	0, 1, 2, 4, 5	0
When printing values measured by the balance with the printer's "Printing" key or while in its timer mode. When printing charts with the printer.	1	3, 6	0
When printing the balance's statistical calculation results. When printing the balance's GLP data output.	1	0, 1, 2, 4, 5, 6	1

5. Connecting to the external display unit

When connecting the external display unit to the balance, configure the external display unit and the balance as follows according to these usage examples.

Internal settings of the external display unit and the balance

Usage example	AD-8920A Remote Display	AD-8922A Remote Controller <i>out</i> Output mode	Balance <i>ModE</i> Connection destination
When only displaying the balance's display value on the external display unit.	No setting	0, 1, 2	2
When printing with the PRINT key of the external display unit with the printer connected to it		1, 2	2
When printing with the printer's "Printing" key or while in its timer mode with the printer connected to the external display unit. When printing charts with the printer.		0	2

- Refer to the instruction manual of the AD-8922A for how to change internal settings of the AD-8922A remote controller.

6. Connecting to a PC or a PLC

6-1. Quick USB mode

The quick USB mode is a function used to connect the balance with the PC using a USB cable to directly input the output data of the balance into PC software such as Excel or Word. Windows XP or later is supported.

Since the balance uses a standard Windows driver (HID), no installation of a special driver is necessary and communication is possible just by connecting the balance to a PC.

Caution

- Quick USB is a one-way communication from the balance to the PC. It is not possible to send control commands from the PC to the balance.
- Turn off the PC's screen saver and stand-by modes.

About internal settings

- With the internal setting of $UFnc \ 0$ (Quick USB ALL) all data is output including the header and units of the weighing data according to the output data format set in the internal setting (USB data format). $U-EP$
- With the internal setting of $UFnc \ 1$ (Quick USB NU) only the weighing data values are output.

Operating instructions (when sending weighing data using the balance's **PRINT** key)

1. Set the internal setting $UFnc$ of the balance to 0 (Quick USB ALL) or to 1 (Quick USB NU).
2. Connect the balance to a PC with the supplied USB cable.
3. When connecting for the first time, the PC will automatically start installing the driver.
4. Start up PC software (Excel, etc.) for transmitting the weighing data.
5. Set the keyboard input mode to half-width characters[A1]. In case of full-width setting activated the data will not be input correctly.
6. Move the cursor to the place you want to input the weighing data.
7. When you press the **PRINT** key on the balance, weighing data will be transmitted from the balance and input at the location of the cursor.
8. Disconnect the USB cable when finished.

6-2. Virtual COM mode

Virtual COM mode is a function used to connect the balance with the supplied USB cable and create a COM port on the PC side for bidirectional communication. Windows XP or later is supported. Except for Windows 10, when using for the first time, you need to install a special driver on the PC. For details on how to install the driver, please refer to "Installing the driver for the GX-A / GF-A series USB interface "Virtual COM mode" on our website (<http://www.aandd.co.jp>).

About internal settings

- When using Virtual COM mode, please put the balance's internal setting $UFnc$ to 2 (bidirectional USB virtual COM).

6-3. RS-232C

The RS-232C interface of the balance is the DCE (Data Communication Equipment) that can be connected to a PC. The RS-232C cable used for connection is the straight type. If there is no RS-232C connector on the PC, please connect in USB Virtual COM mode.

6-4. WinCT data transmission software (USB Virtual COM mode or RS-232C)

When a PC is connected through a USB connection in virtual COM mode or with a RS-232C cable, weighing data can be easily received by the PC with the use of the WinCT data communication software for Windows. WinCT can be downloaded from our website (<http://www.aandd.co.jp>). Please refer to "WinCT setup procedures" and "WinCT operation manual" on our website (<http://www.aandd.co.jp>) for installation and setup.

There are 3 applications in WinCT: RsCom, RsKey and RsWeight.

RsCom

- You can control the balance by sending a command to it.
- Received data can be displayed and saved as a text file (.txt).
- By executing the software multiple times, you can communicate with multiple balances.
- It can be executed simultaneously with other applications. (Does not exclusively occupy the PC)
- GLP output data can also be received from the balance.

RsKey

- Weighing data from the balance can be input directly into another applications.
- If input by keyboard (e.g. with Word or Excel) is possible, the type of application does not matter.
- GLP output data from the balance can also be input.
- The PC can be made into an external display for the balance through the use of the test display function.

RsWeight

- Received data can be graphed in real time.
- Parameters of received data such as maximum value, minimum value, average value, standard deviation, coefficient of variation, etc. can be calculated and displayed.

7. Data output

7-1. Data output mode

As for the balance's data output timing, it can be changed with the internal setting *Prt* (data output mode).

Key mode **Internal setting** *dout Prt 0*

If the PRINT key is pressed when the stable value mark is displayed, the weighing value will be output once.

At that time the displayed weighing value will blink once to indicate that it had been output.

Auto print A mode **Internal setting** *dout Prt 1*

When the weighing value exceeds the range specified by the internal setting *AP-P* (auto print polarity) and the internal setting *AP-b* (auto print width) from the standard "zero display" and the stable value mark is on, the weighing value will be output once. Also, if the PRINT key is pressed while the stable value mark is on, the weighing value will be output once.

At that time the displayed weighing value will blink once to indicate that it had been output.

Related internal settings

dout AP-P Auto print polarity

dout AP-b Auto print width

Auto print B mode **Internal setting** *dout Prt 2*

When the weighing value exceeds the range specified by the internal setting *AP-P* (auto print polarity) and the internal setting *AP-b* (auto print width) from the standard "value previously displayed with a stable value mark" and the stable value mark is on, the weighing value will be output once. Also, if the PRINT key is pressed while the stable value mark is on, the weighing value will be output once. At that time the displayed weighing value will blink once to indicate that it had been output.

Related internal settings

dout AP-P Auto print polarity

dout AP-b Auto print width

Stream mode **Internal setting** *dout Prt 3*

Regardless of the presence or absence of the stable value mark, weighing value will be output for each internal setting *SPd* (display rewrite cycle). When the internal setting is *SPd 0* (5 times / sec), the output is at approximately 5.21 Hz.

Related internal settings

bASFnC SPd Display rewrite cycle

SIF bPS Baud rate

Caution

- Depending on the display rewrite cycle and the baud rate, all data may not be transmitted unless the baud rate is increased.

Key mode B mode **Internal setting** *dout prt 4*

Regardless of the presence or absence of the stable value mark, when the PRINT key is pressed, the weighing value will be output once.

At that time the displayed weighing value will blink once to indicate that it had been output.

Key mode C mode **Internal setting** *dout prt 5*

When the PRINT key is pressed and the stable value mark is displayed, the weighing value will be output once. In case the stable value mark is not displayed, the weighing value will be output once the stable value mark is displayed next time.

At that time the displayed weighing value will blink once to indicate that it had been output.

Interval mode **Internal setting** *dout prt 6*

Regardless of the presence or absence of the stable value mark, values will be output at an interval of the internal setting *int* (interval time). By pressing the PRINT key data output is started and stopped by pressing it again during the data output.

Related internal settings
dout int Interval time
5,1f bps Baud rate

Caution

- Depending on the interval time and the baud rate, all data may not be transmitted unless the baud rate is increased.

7-2. Weighing data format

As for the balance's weighing data output, for USB it can be changed by the internal setting U-tP (USB data format) and for RS-232C – by the internal setting `TYPE` (data format).

Standard format A&D **RS-232C connection : internal setting** `SIF TYPE 0`
USB setting : internal setting `USB U-tP 0`

- This is the standard format for sending data to peripheral devices.
- Consists of 15 characters (excluding the terminator).
- The condition of the data is indicated with a 2-character header.
- The data is padded with polarity and zeros (filling the data's higher order's surplus part with zeros).
- If the data is zero, the polarity is positive.
- The unit consists of three characters.

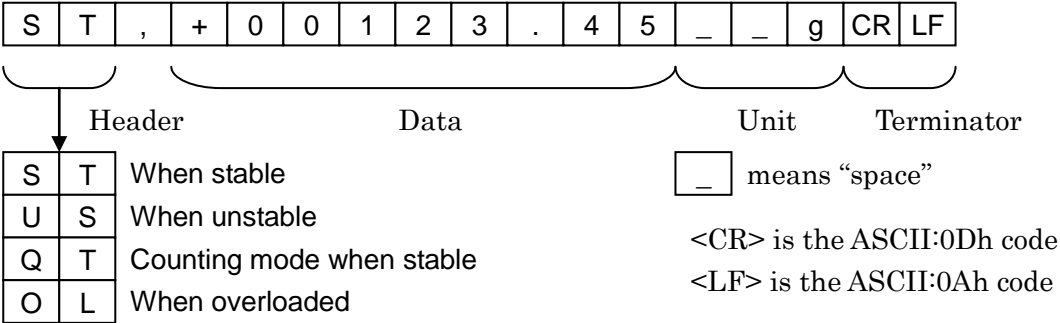

- Printing pattern of the AD-8127 compact printer is as follows:

```
WT, +1234.56 g
```

DP format (Dump print) **RS-232C connection : internal setting** `SIF TYPE 1`
USB connection : no function

- This format is suitable for dump printing.
- Consists of 16 characters (excluding the terminator).
- The condition of the data is indicated with a 2-character header.
- The polarity sign is added right before the data if the data is not overloaded or zero.
- The data is zero-suppressed (leading zeros are replaced with spaces).
- The unit consists of three characters.

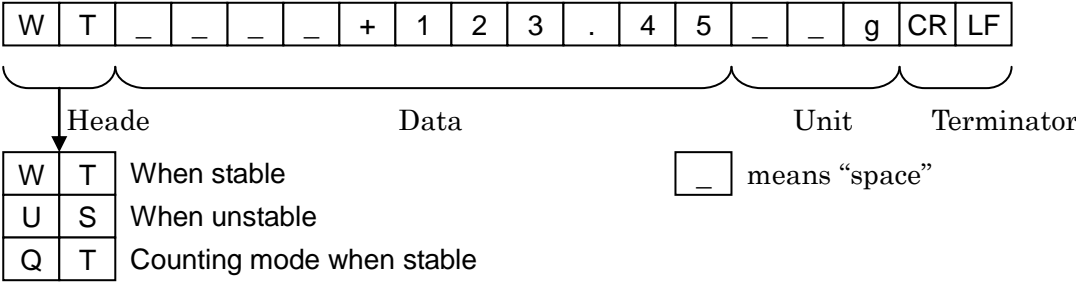

CSV format

RS-232C connection : internal setting 5, F TYPE 5

USB connection : internal setting USB U-TP 2

- Separates the data of A&D standard format and the unit by a comma (,).
- Outputs the unit even when the data is overloaded.
- When the decimal point is set to comma (,), semicolon (;) will be used as the separator.

S	T	,	+	0	0	1	2	3	.	4	5	,	_	_	g	CR	LF
---	---	---	---	---	---	---	---	---	---	---	---	---	---	---	---	----	----

- When other data is added to the weighing value, all data will be displayed in one line.
The display sample will be as follows if the ID number, data number, date and time are added.

SAMPLE-0123-4, No, 012, 2017/07/01, 12:34:56, ST, +00123.45, g

┌──────────┐		┌──┐		┌──────────┐			┌──┐		┌──────────┐			
ID		Data number		Date			Time		Weighing			
number									data			

TAB format

RS-232C connection : no function

USB connection : internal setting USB U-TP 3

- This is a format, in which the separator of the CSV format is changed from comma to TAB.

S	T	TAB	+	0	0	1	2	3	.	4	5	TAB	_	_	g	CR	LF
---	---	-----	---	---	---	---	---	---	---	---	---	-----	---	---	---	----	----

<TAB> is the ASCII:09h code

7-3. Output examples of weighing data format

When stable



A&D	S	T	,	+	0	3	1	4	2	.	0	6	_	_	g	CR	LF	
DP	W	T	_	_	_	+	3	1	4	2	.	0	6	_	_	g	CR	LF
KF	+	_	_	3	1	4	2	.	0	5	_	g	_	_	CR	LF		
MT	S	_	_	_	_	3	1	4	2	.	0	6	_	g	CR	LF		
NU	+	0	3	1	4	2	.	0	6	CR	LF							

When unstable



A&D	U	S	,	-	0	0	2	9	5	.	8	7	_	_	g	CR	LF
DP	U	S	_	_	_	-	2	9	5	.	8	7	_	_	g	CR	LF
KF	-	_	_	_	2	9	5	.	8	7	_	_	_	_	CR	LF	
MT	S	D	_	_	_	-	2	9	5	.	8	7	_	g	CR	LF	
NU	-	0	0	2	9	5	.	8	7	CR	LF						

When overloaded

(plus)



A&D	O	L	,	+	9	9	9	9	9	9	E	+	1	9	CR	LF	
DP	_	_	_	_	_	_	_	E	_	_	_	_	_	_	_	CR	LF
KF	_	_	_	_	_	H	_	_	_	_	_	_	_	_	CR	LF	
MT	S	I	+	CR	LF												
NU	+	9	9	9	9	9	9	9	9	CR	LF						

When overloaded

(minus)

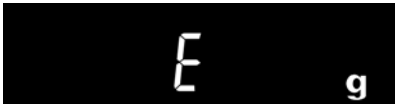

A&D	O	L	,	-	9	9	9	9	9	9	E	+	1	9	CR	LF	
DP	_	_	_	_	_	_	-	E	_	_	_	_	_	_	_	CR	LF
KF	_	_	_	_	_	L	_	_	_	_	_	_	_	_	CR	LF	
MT	S	I	-	CR	LF												
NU	-	9	9	9	9	9	9	9	9	CR	LF						

7-4. Other data formats

In addition to weighing data, other data can be added. Switch each internal setting on / off as necessary.

Data number Internal setting *dout d-no 1*

- When the data memory function is used, the data number is output.
- Consists of 6 characters (excluding the terminator).

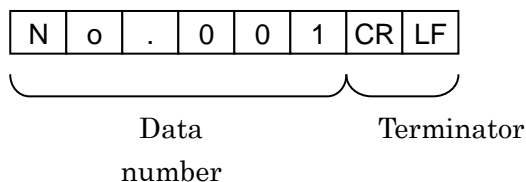

ID number Internal setting *dout 5-id 1*

- The ID number stored in the balance is output.
- Consists of 13 characters (excluding the terminator).

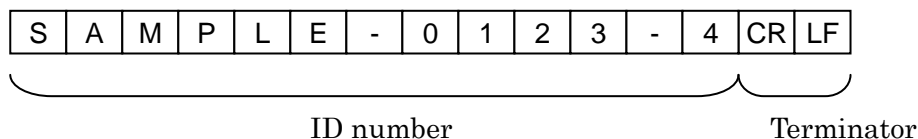

Date Internal setting *dout 5-td 2 or 3*

- The date is output from the clock data of the balance.
- The order of YYYY/MM/DD can be changed in settings.
- Consists of 10 characters (excluding the terminator).

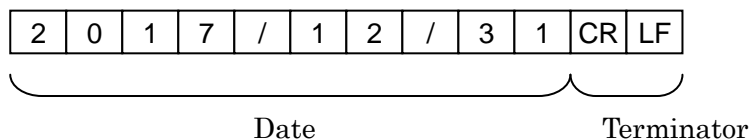

Time Internal setting *dout 5-td 1 or 3*

- The time is output from the clock data of the balance.
- 24-hour format.
- Consists of 8 characters (excluding the terminator).

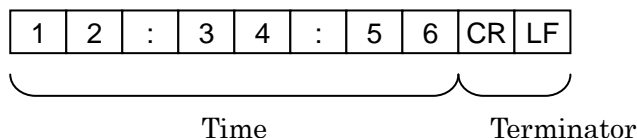

8. Commands

By sending a specified command from a PC or a PLC to the balance, you can control the balance such as by requesting weighing data, manipulating various keys and changing the setting value. To send a command to the balance, add a terminator (<CR> <LF> or <CR> in the [rLf]ial setting) to the command character string.

8-1. Control commands

Commands to query weighing data

Command string	Function
Q	Requests the weighing data immediately
RW	Requests the weighing data immediately
SI	Requests the weighing data immediately
S	Requests the weighing data when stabilized.
<ESC>P	Requests the weighing data when stabilized.
SIR	Requests the weighing data continuously. (Stream output)
C	Cancels the S, <ESC>P or SIR command.

- The Q, RW and SI commands behave the same.
- The S and <ESC>P commands behave the same.
- <ESC> : Escape code, ASCII:1Bh code

Key control commands

Command string	Function
P	Same as the ON:OFF key
ON	Turns the display on.
OFF	Turns the display off.
CAL	Same as the CAL key : Calibration with built-in weight (GX-A Series) Calibration with a separate weight (GF-A Series)
EXC	Calibration with a separate weight (GF-A Series)
U	Same as the MODE key
SMP	Same as the SAMPLE key
PRT	Same as the PRINT key
R	Same as the RE-ZERO key (Semi-automatic zero point setting)
Z	Same as the RE-ZERO key (Semi-automatic zero point setting)
RZ	Same as the RE-ZERO key (Semi-automatic zero point setting)
T	Tares the balance
TR	Tares the balance
ZR	Zero (Setting the zero point)

- The R, Z and RZ commands behave the same.
- The T and TR commands behave the same.

Commands for presetting the tare value

Command string	Function
PT : * * * * . * * g	Sets the tare value. The unit added is the unit that is output in the A&D standard format (3 characters). For the counting or percent mode, gram is used. In the case of setting the preset tare value to 1234.56 g, the input will be <u>PT:1234.56</u> g. Values exceeding the weighing capacity cannot be set. Negative values cannot be used.
?PT	Requests the tare value. Outputs the tare value set by the PT, T or TR: command.

Command to control piece count

Command string	Function
UW : * * * * . * * g	Sets the unit mass value (weight of 1 piece) The unit added is the unit that is output in the A&D standard format (3 characters). In the case of setting the unit mass value to 1.23 g, the input will be <u>UW:1.23</u> g. Values exceeding the weighing capacity cannot be set. Negative values cannot be used.
?UW	Requests the mass unit value.
UN : mm	Changes the unit mass registration number. Input values from 01 to 50 before mm.
?UN	Outputs the unit mass number of the selected unit mass.

Commands to control the comparator function

Command string	Function
HI : * * * * . * * g	Sets the upper limit value.
HH : * * * * . * * g	Sets the second upper limit value.
LO : * * * * . * * g	Sets the lower limit value.
LL : * * * * . * * g	Sets the second lower limit value. The unit added is the unit that is output in the A&D standard format (3 characters). In the case of setting the upper limit value to 567.89 g, the input will be <u>HI:567.89</u> g. Values exceeding the weighing capacity cannot be set.
?HI	Requests the upper limit value.
?HH	Requests the second upper limit value.
?LO	Requests the lower limit value.
?LL	Requests the second lower limit value.

- To use a comparator command, set it to the internal setting $[P_{in} 0]$ (digital input, upper / lower limits) or $[P_{in} 1]$ (Weighing input, upper / lower limits).

Command to control the data memory function

Command string	Function
?MA	Outputs all data in memory.
?MQnnn	Outputs weighing data with the data number nnn. Input a value from 001 to 200 before nnn.
?MX	Outputs the number of weighing data in memory.
MD : nnn	Deletes weighing data with the data number nnn. Input a value from 001 to 200 before nnn.
MCL	Deletes all data in memory.

Commands for setting time and date

Command string	Function
TM : ** : ** : **	Sets time. In the case of setting time to 12h 34 min 56 sec, the input will be <u>TM:12:34:56</u> . Do not set non-existing time values.
DT : ** / ** / **	Sets date. In the case of setting date to Jan 1, 2017, the input will be <u>DT:17/01/23</u> . Do not set non-existing date values.
?TM	Requests time setting.
?DT	Requests date setting.

Commands to request other data

Command string	Function
?T	Requests the tare weight value. The tare value set by T, TR command is output.
?ID	Requests ID number.
?SN	Requests serial number.
?TN	Requests device name.

8-2. The <AK> code and error codes

When the internal setting *ErCd 1* (AK, error code on) is set, the balance always responds to reception of all commands sent from a PC or a PLC. Communication reliability is improved by checking the responding code.

When the internal setting *ErCd 1* (AK, error code on) is set, the balance responds with the following.

- When sending a command requesting various data to the balance, if the balance cannot transmit the requested data, it sends an error code (EC, Exx). If the balance can output the requested data, the requested data will be sent.
- When sending a controlling command to the balance, if the balance cannot execute the command, it sends an error code (EC, Exx). If the balance can execute the command, it sends the <AK> code.
<AK> code is the ASCII 06h code.
- The commands below are processed by the balance, so it will send the <AK> command not only when a command is received, but also at the end of processing. If the process does not end normally, the balance sends an error code (EC, Exx), in which case the error is canceled with the CAL command.

ON command	Display on
P command	Display on / off (However, only when already on)
R, Z, RZ commands	Re-zero (Semi-automatic zero point setting)
T, TR commands	Tare the balance
ZR command	Zero (Setting the zero point)
CAL command	Calibration with built-in weight (GX-A Series) Calibration with a separate weight (GF-A Series)
EXC command	Calibration with a separate weight (GX-A Series)

8-3. Command usage examples

In this example in order to force an output of the <AK> code the internal setting *ErCd 1* (AK, error code on) is set. <AK> code is the ASCII 06h code.

Example of the ON command (display on)

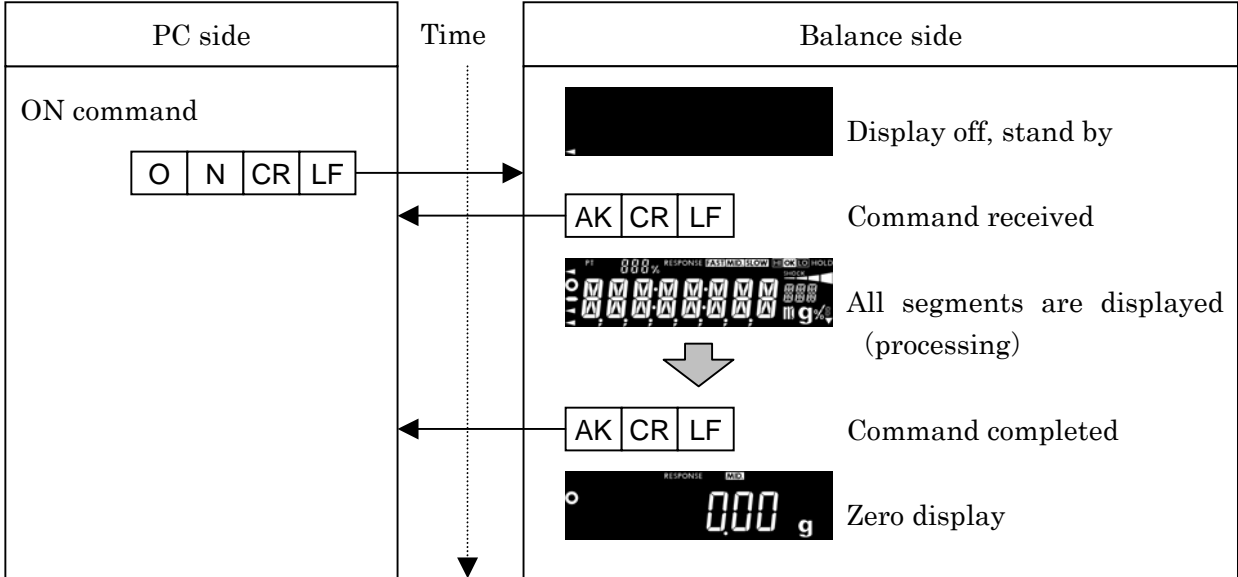

Example of the R command (Re-zero)

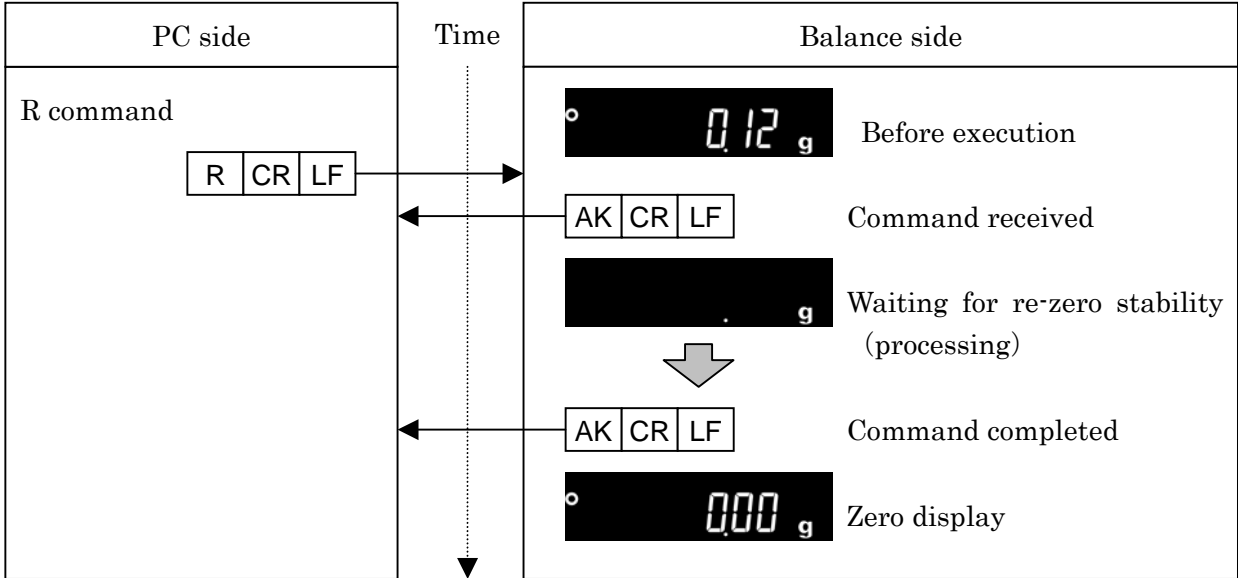

Example of the CAL command (GX-A Series) Calibration with built-in weight

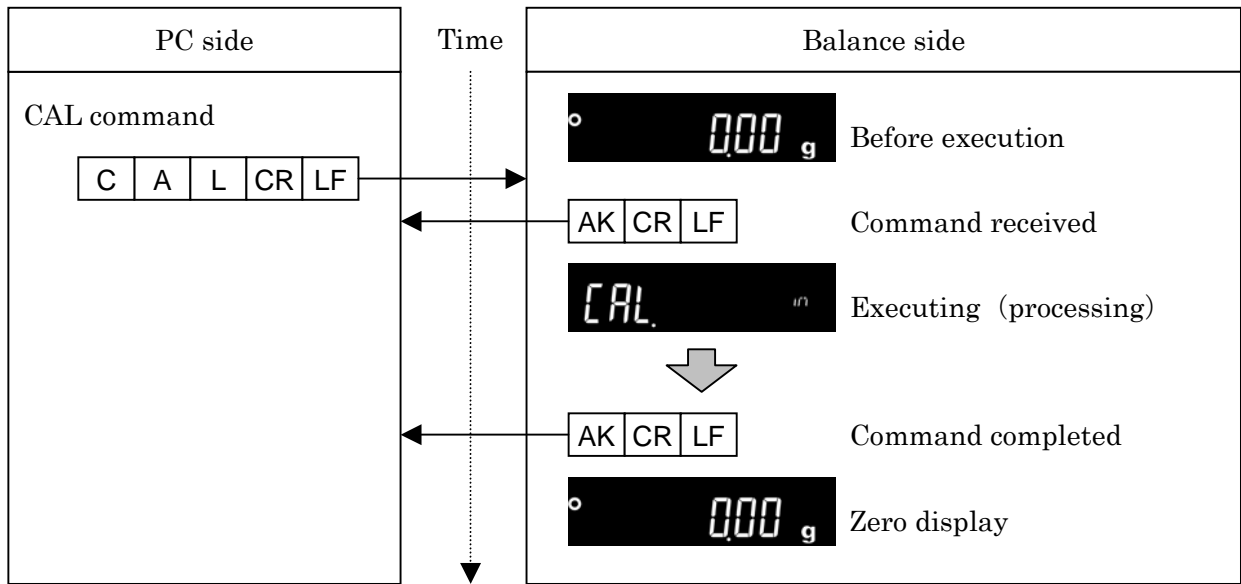

□ For an example of the CAL command for the GF-A series, see the example of the EXC command.

Example of error code output of the R command (re-zero)

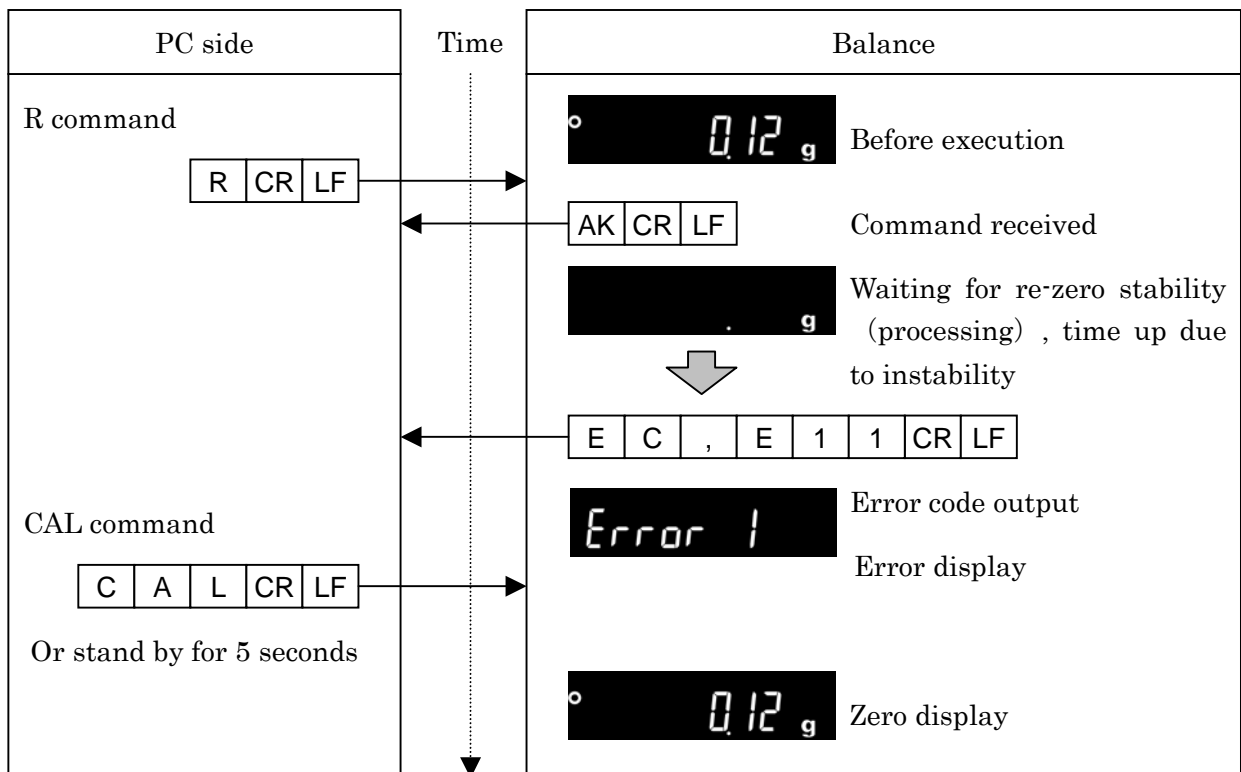

Example of the EXC command Calibration with a separate weight (GF-A Series)

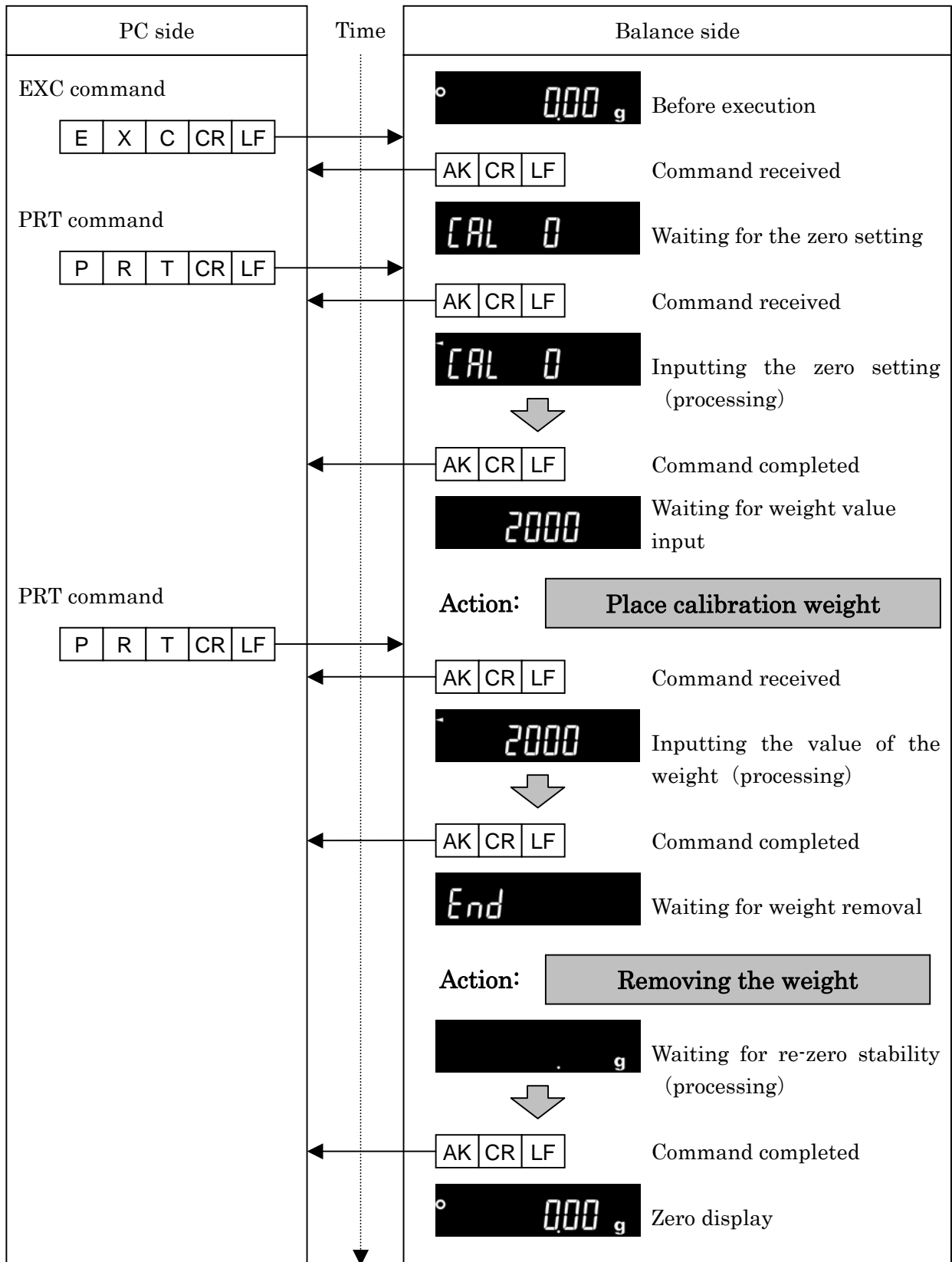

Example of measuring using a container

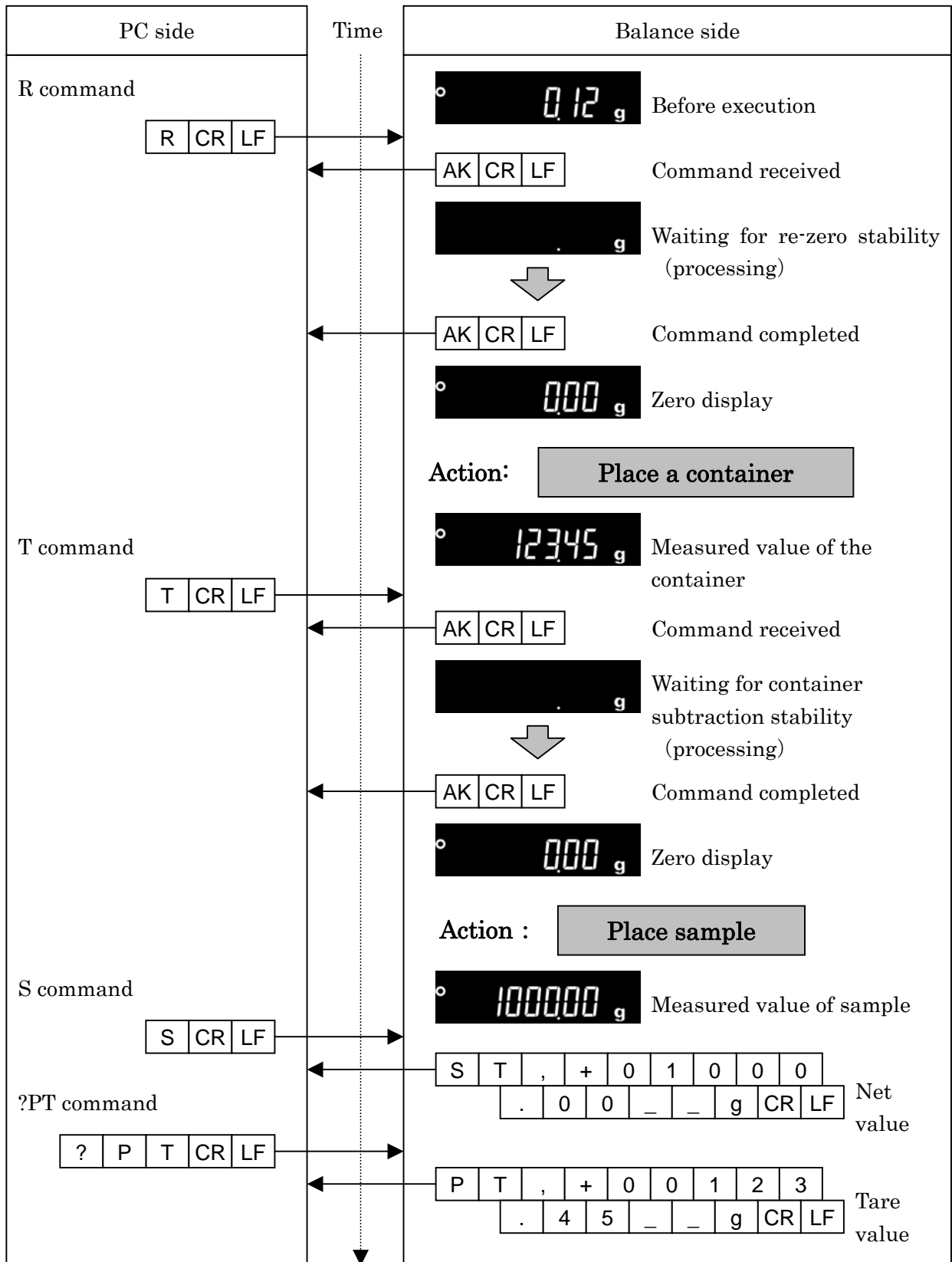

Example of setting a negative target value and filling with a sample until the display becomes zero

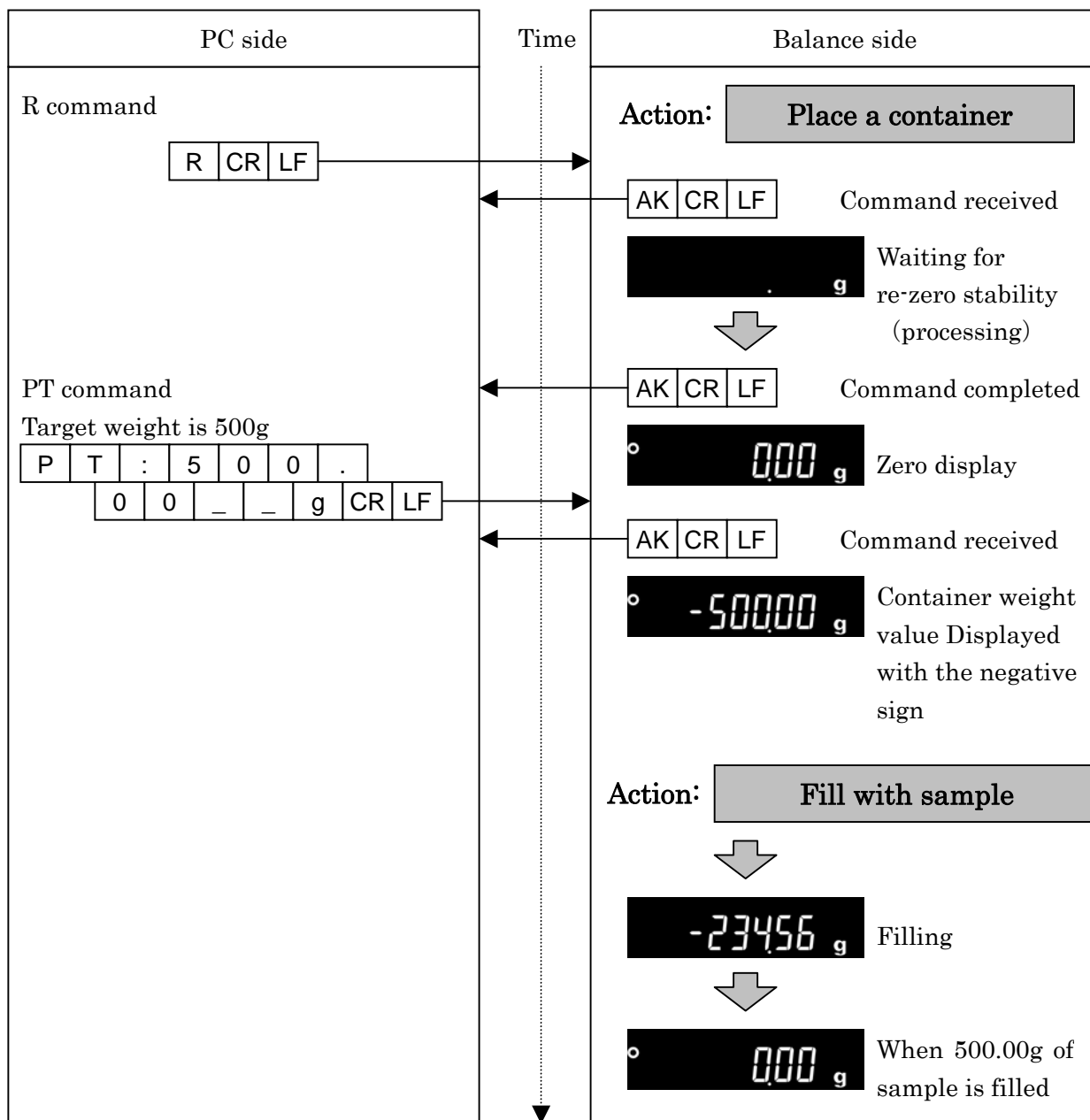

9. Error codes

9-1. Error codes list

Error codes and how to resolve

Error code	Description and how to resolve
EC,E00	Communications error A protocol error occurred in communications. Check the format and the baud rate.
EC,E01	Undefined command error An undefined command was received. Check the command.
EC,E02	Not ready The command received cannot be processed. e.g. The balance received a Q command, which requested the weighing data, but it was not in the weighing mode with the display on. e.g. The balance received a Q command while processing a RE-ZERO command. Adjust the timing of transmitting the command.
EC,E03	Timeout error The internal setting of the timeout parameter is set to 1-UP (limit set to 1 second for the command timeout), so the balance did not receive the next command within the time limit of one second. Check the communication.
EC,E04	Excess characters error The balance received excessive characters in a command. Check the command.
EC,E06	Format error The format of the received command is incorrect. e.g. The data is numerically incorrect. e.g. Alphabet characters are input instead of values. Check the command.
EC,E07	Setting value error The received data exceeds the range of values that the balance can accept. Check the parameter values range of the command.
EC,E11	Weighing values stability error Because the weighing value is unstable, it is not possible to rezero or calibration. Improve the environment of the location where the balance is installed. Send a CAL command or wait 5 seconds to reset the error.

Error code	Details and ways to address
EC,E16	<p>Built-in weight error</p> <p>There was no change in load even when the built-in weight was raised and lowered.</p> <p>Perform the weighing operation from the beginning without placing anything on the pan.</p>
EC,E17	<p>Built-in weight error</p> <p>There was an error in the mechanism of raising and lowering the built-in weight.</p> <p>Perform the weighing operation from the beginning.</p>
EC,E20	<p>Calibration weight error (heavy)</p> <p>The calibration weight is too heavy.</p> <p>Check the nominal calibration weight value.</p> <p>Send a CAL command or wait 5 seconds to reset the error.</p>
EC,E21	<p>Calibration weight error (light)</p> <p>The calibration weight is too light.</p> <p>Check the nominal calibration weight value.</p> <p>Send a CAL command or wait 5 seconds to reset the error.</p>

10. The UFC function

By using the UFC (Universal Flex Coms) function, it is possible to arbitrarily output contents of your choice when outputting the weighing data. You can also output a character string when printing a barcode with a label printer or the like.

In order to use the UFC function, it must be set to internal setting `UFC 1` (UFC function on).

10-1. UFC program commands

To select the output format to use, send the program command from the PC and store it in the balance. The stored output format is saved even when the balance is turned off.

How to create program commands

- The maximum number of characters of a program command is 32 characters per line (including the terminator) with the total maximum being 384.
- First, add the PF, command.
- Program commands are combined in comma-delimited or space-separated form, but they can be omitted to reduce the number of characters. However, the comma after the PF command cannot be omitted.

List of program commands

Command	Contents	Example of output
PF,	UFC command header It is appended to the beginning of the program command.	
\$MN	Manufacturer name	A & D
\$TY	Model name	GX-10002A
\$SN	Serial number	T1010101
\$ID	ID number	SAMPLE-1234-5
\$DT	Date	2017/01/23
\$TM	Time of Day	12:34:56
\$WT	Weight data	+1234.56 g
\$GR	Gross data (total amount)	+1234.56 g
\$NT	Net data (net)	+234.56 g
\$TR	Tare data (tare)	+1000.00 g
\$PC	Number data	+1234 PC
\$UW	Single data	+0.12 g
\$CP	Comparator result	HI
\$CM	Comma	,
\$SP	Space	_ (ASCII 20h code)
\$CR	<CR>	ASCII 0Dh code

\$LF	<LF>	ASCII 0Ah code
------	------	----------------

- Enclose any ASCII code string in single quotation marks. The character strings that can be output are alphanumeric characters and symbols. In addition, the single quotation marks themselves are enclosed in two single quotation marks.
Example: To output the character string ABC: 'ABC'
To output the character string 'ABC': "'ABC'"
- To output the ASCII control code, enter '# + 2 hexadecimal characters'.
Example: To output <EOT> (04h): # 04
- Spaces (\$ SP), <CR> (\$ CR), and <LF> (\$ LF) can be repeated with numbers by adding '* + numbers (up to 2 characters)' after the command.
Example: To output 12 spaces: \$ SP * 12
To output 9 <CR>'s : \$ CR * 9
- When sending a program command of two or more lines, adding '&' at the end of one line the balance will judge the next line as the continuation of the program command.
- The balance sends an error code if there is a problem after receiving a program command and sends an <AK> code if there is no problem. <AK> code is ASCII 06h code.
- WinCT-UFC Data communication software is available for inputting program commands. WinCT-UFC can be downloaded from our website (<http://www.aandd.co.jp>).

10-2. Examples of creating UFC program commands

Output example 1

```
NET
      +2000.00  g
TARE
      +345.67  g
GROSS
      +2345.67  g
```

Description

PF, command, character string "NET", line break

Space × 5, net data, line break

Character string "TARE", line break

Space × 6, tear data, line break

Character string "GROSS", line break

Example of program command

```
PF,'NET',$CR,$LF,&
$SP*5,$NT,$CR,$LF,&
'TARE',$CR,$LF,&
$SP*6,$TR,$CR,$LF,&
'GROSS',$CR,$LF,&
$SP*5,$GR,$CR,$LF
```

⏟

Terminator

Output example 2

```
2017/01/23 12:34:56
SAMPLE      ABC-123
WEIGHT     +3456.78  g
```

Content

PF, command, date, time, line break

Character string "SAMPLE ABC-123", line break

Character string "WEIGHT ", weight data

Example of program command

```
PF,$DT,$TM,$CR,$LF,&
'SAMPLE      ABC-123',$CR,$LF,&
'WEIGHT     ', $WT,$CR,$LF
```

⏟





Terminator

11. Internal settings

By changing internal settings of the balance, you can customize balance usage. The contents of the settings are saved even when the AC adapter is unplugged and they are effective until set again. In the internal settings menu structure each setting entry is placed in its classification item and one setting value is registered for each setting entry.

11-1. How to set

Operation keys and indication

	The ○ mark is displayed for the currently active setting values.
	Press and hold while the weighing value is being displayed to enter the internal settings menu. (the classification item menu) Then move between items in the internal settings menu.
	Change the setting value (by +1). When it exceeds the maximum set value, it returns to 0.
	Enter the settings menu from the classification items menu. Input the value and move to the next classification item.
	In the settings menu push to cancel the input value and move to the next classification item. In the classification menu push to complete internal settings and return to the value indication screen.

Procedure for changing settings

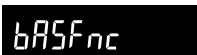
- Press and hold the **[SAMPLE]** key while the weighing value is displayed, release the key when  is displayed.
- Continue to the classification item to be set with the **[SAMPLE]** key.
- Enter into the classification item currently displayed with the **[PRINT]** key. The first setting item is displayed.
- Use the **[SAMPLE]** key to toggle between the setting item to be set.
- The value of the setting item currently displayed key can be increased by 1 with the **[RE-ZERO]** key. Keep pressing the **[RE-ZERO]** key until you reach the value you would like to set.
- Repeat steps 4 and 5 to change other setting item(s) within the same classification item.
If you want to move to another category, continue to step 7.
- To confirm (register) the setting of the current classification item, press the **[PRINT]** key. The setting value is saved and you proceed to the next classification item.
To cancel the setting of the current classification item, press the **[CAL]** key. The set value is canceled and you proceed to the next classification item.
- Repeat from step 2 to make settings in another category.
To finish configuration, press the **[CAL]** key. You will return to the weighing screen.

Configuration example

Example of setting "Time/Date output" to "outputting Time/Date" and "Data format" to "DP format".

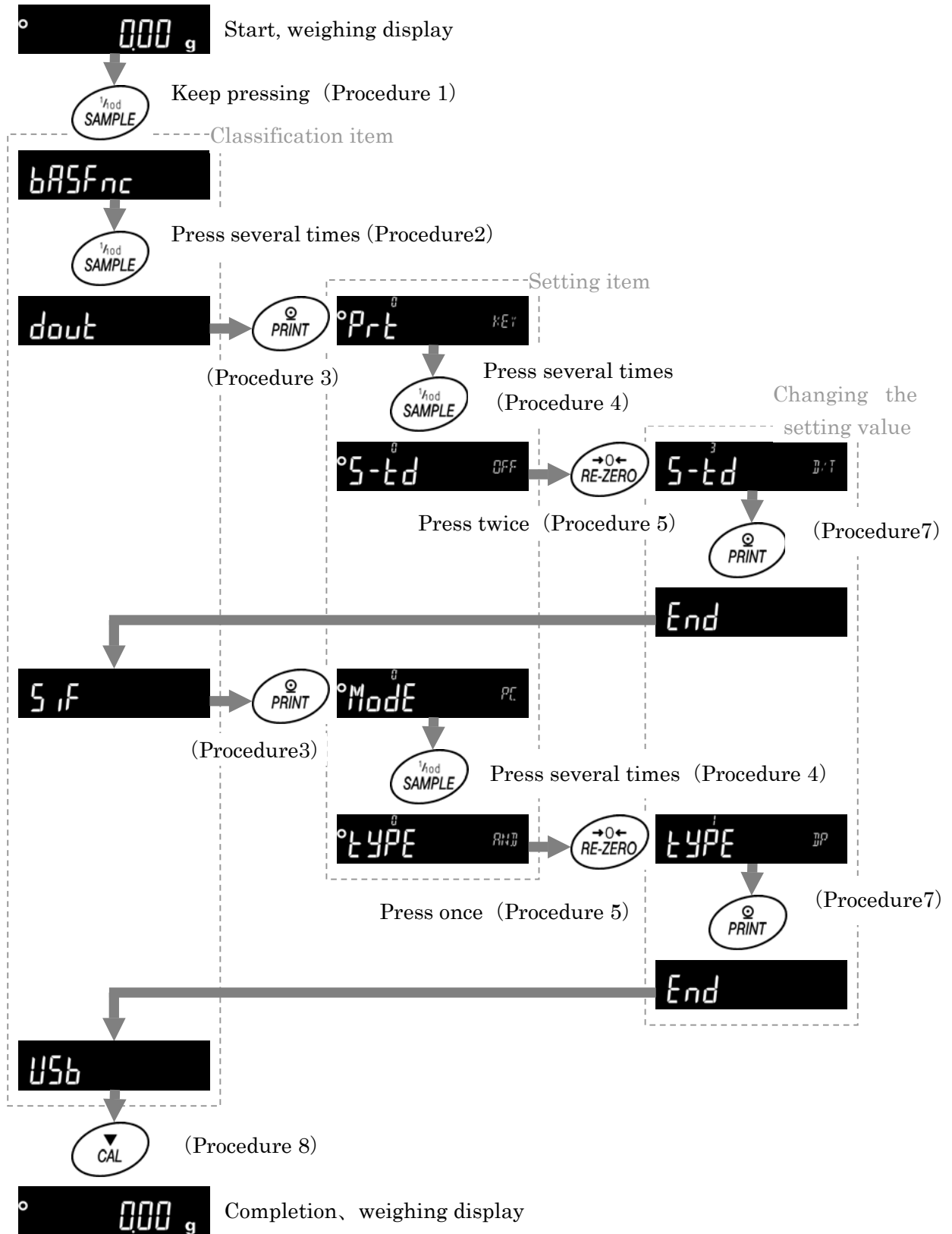

11-2. List of items (communication entries only)

This is a list of items related to communication of internal setting values. For other items, refer to the GX-A / GF-A instruction manual.

Classification item	Setting item	Setting value	Contents, usage	
<i>bRSFnc</i> ⋮ <i>CP bEEP</i>			Refer to the GX-A / GF-A instruction manual	
<i>dout</i> Data output	<i>Prt</i> Data output mode	■ <i>0</i>	Key mode	Data output with the PRINT key when the weighing value is stable
		<i>1</i>	Auto print A mode (reference = zero point)	Data output of a stable weighing value when it exceeds the range of <i>AP-P</i> and <i>AP-b</i> in relation to zero.
		<i>2</i>	Auto print B mode (reference = previous stable value)	Data output of a stable weighing value when it exceeds the range of <i>AP-P</i> and <i>AP-b</i> in relation to previous stable value.
		<i>3</i>	Stream mode	Output every time when the display value is renewed
		<i>4</i>	Key mode B mode (immediate output)	Data output regardless of stability / instability with the PRINT key
		<i>5</i>	Key mode C mode	Data is output when stable with the PRINT key and if unstable, it is output once it has stabilized
		<i>6</i>	Interval mode	Data output after every cycle set by the <i>int</i> setting
	<i>AP-P</i> Auto print Polarity	<i>0</i>	Only plus	When greater than reference value
		<i>1</i>	Only minus	When smaller than reference value
		■ <i>2</i>	Bipolarity	Regardless of the value size compared with reference value
	<i>AP-b</i> Auto print difference	■ <i>0</i>	10 digits	Difference from reference value
		<i>1</i>	100 digits	
		<i>2</i>	1000 digits	

- “■” Factory setting.
- “1 digit” stands for a smallest displayed order. In case of GX-303A 1 digit is 0.001g.

Classification item	Setting item	Setting value	Contents, usage	
<i>dout</i> Data output (Cont.)	<i>DATA</i> Data memory function	■ 0	No used	
		1	Stores unit mass	
		2	Stores weighing data, and calibration data	
	<i>int</i> Interval time	0	Every measurement	Used when outputting with intervals set in <i>Prt 6</i>
		■ 1	Every 2 seconds	
		2	Every 5 seconds	
		3	Every 10 seconds	
		4	Every 30 seconds	
		5	Every 1 minute	
		6	Every 2 minutes	
		7	Every 5 minutes	
	<i>d-no</i> Data number output	■ 0	Do not output	Refer to "7-4. Other data formats"
		1	Output	
	<i>S-td</i> Time/Date output	■ 0	Do not output	Refer to "7-4. Other data formats"
		1	Output time	
		2	Output date	
	<i>S-id</i> ID number output	■ 0	Do not output	Refer to "7-4. Other data formats"
		1	Output	
	<i>PUSE</i> Data output pause	■ 0	Off	Select interval before data output
		1	1.6-second pause	
	<i>Alt-F</i> Auto feed	■ 0	Off	Select line feed (paper feed) after data output
1		Leave one line open		
<i>info</i> GLP output	■ 0	Do not output		
	1	Output		
<i>Ar-d</i> Auto re-zero	■ 0	Off	Select re-zero after data output	
	1	On		
<i>UFC</i> UFC function	■ 0	Off	Refer to "10. The UFC function"	
	1	On		

□ “■” Factory setting.

Classification item	Setting item	Setting value	Contents, usage		
SIF Serial interface	Mode Connection destination	▪ 0	PC		
		1	Printer	TYPE 0 or 1	
		2	External display	TYPE 0 and stream output	
	bps Baud rate	0	600 bps		
		1	1200 bps		
		▪ 2	2400 bps		
		3	4800 bps		
		4	9600 bps		
		5	19200 bps		
	bPr Data bit, parity bit	▪ 0	7 bit EVEN		
		1	7 bit ODD		
		2	8 bit NONE		
	CrLF Terminator	▪ 0	CR LF	CR: ASCII 0 Dh code	
		1	CR	LF: ASCII 0 Ah code	
	tYPE Data format	▪ 0	A&D Standard format		Refer to "7-2. Weighing data format"
		1	DP format		
		2	KF format		
		3	MT format		
		4	NU format		
	t-UP Timeout	▪ 0	No limit	Select waiting time during command reception	
1		Limited to 1 second			
ErEd AK, error code	0	Off	Refer to "8-2. The <AK> code and error codes"		
	▪ 1	On			
USB USB Interface	UFnc USB operation mode	▪ 0	Quick USB ALL	See "6-1. Quick USB mode"	
		1	Quick USB NU	See "6-2. Virtual COM mode"	
		2	Bidirectional USB virtual COM		
	U-tP USB Data format	▪ 0	A&D standard format	Refer to "7-2. Weighing data format"	
		1	NU format		
		2	CSV format		
		3	TAB format		
AP Fnc : CS in			Refer to the GX-A / GF-A instruction manual		

□ "▪" Factory setting.

Caution

- 1) Unauthorized reproduction of any part or all of the contents of this document is strictly prohibited.
- 2) The contents of this document are subject to change without notice.
- 3) If you have any doubts about or notice any mistakes in the contents of this document, please contact your dealer or our nearest sales office.
- 4) As for any claims for damages, loss of profit, etc. related to the operation of this machine regardless of the proposed actions from above-mentioned clause 3), our company bears no responsibility with regard to such claims.

© 2017 A&D Company, Limited.

Do not copy or modify this document without the permission of A&D Company, Limited.

Microsoft, Windows, Excel, Word are trademarks of the Microsoft Corporation registered in the United States and other countries.